



PRODUCT CATALOG

永續寶工 ——— INNOVATION . QUALITY . SERVICE

35
Pro'sKit®
YEARS
ANNIVERSARY

VOL.33

CELEBRATING 35 YEARS

**WE OFFER
TOTAL SOLUTION
TOOLS TO
SERVE OUR
GLOBAL CUSTOMERS.**

In the last 10 years, Pro'sKit moved through themes of "Change" and "Focus", each as our 25th and 30th anniversary slogan, respectively.

Now at the mark of 35, we will implement "Sustainable" as our goal. We'd like to invest in more resources on developing solution tools in professional fields such as green energy, fiber optics, and education, as the world needs more computing power and less pollution.

While we contemplate on how to stay sustainable and move forward as a society, Pro'sKit will keep providing the best total solution and service to our beloved customers.

We are very grateful for your support as it allow us to stay resilient to the ever-changing environment.

Founder & Chairman,



TOTAL SOLUTION FOR ALL

Pro'sKit has been one of the leading brands in many professional fields such as those listed below, and we continue to develop more industry specific tools to provide as wide of selection while maintaining high quality.



Fiber Optics



Network & Telecom



3C Electronic



Factory Assembly Line



Hobbyist / DIY

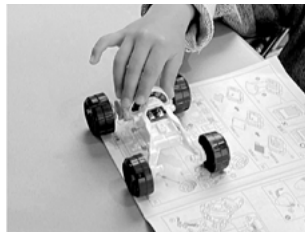

Education



Electrical & Automobile

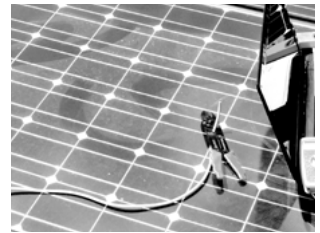

Renewable Energy

A GLIMPSE OF HISTORY...

Pro'skit has been at the forefront of innovation and quality assurance. We've complied with international standard ISO 9001:2000 since 2002, built a complete in-house testing laboratory to provide the finest product and service.



PK-500

1991

Established in Taipei by Leonard Chang & Jennifer Chan with the first iconic product line - Tool Kits.

2001

Established Shanghai office.



Created Soldering & Desoldering product line.

2002

Created Telecom Electronic product line.

1994



903-150N



2010

Created Power Tool product line.
Established standard brand color.



30th Anniversary.

2021

Created VDE product line.

2015



Focusing more on Fiber Optics
and offering more industry
standard solution set.

2024



The Paris Agreement "Net-Zero" urges all governments and businesses to reduce green house gas emmission to 0 by 2050.

GREENER FUTURE

As we move forward, we strive to become more conscious of the impact we make as a business by incorporating ESG within our organization and beyond.

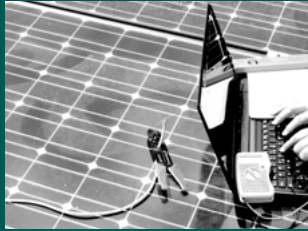

Renewable Energy

With innovation as one of our core value, every year Pro'sKit puts in resources into developing products that aligns with sustainability.



Donation

Every year Pro'sKit donates to organizations in Taiwan, offering resources to kids in rural area, pushing equal rights in education.

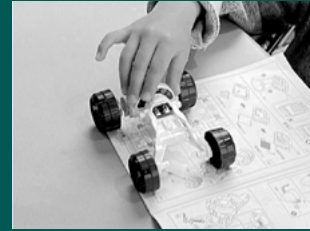





























Education









Our sub-brand Science Kits create deeper link to the educational sector in Taiwan, teaching kids the importance of green energy.

SYMBOLS

SCREWDRIVER BIT

-  Slotted
-  Hex
-  Triangle
-  Wing nut driver
-  Square
-  Square tamper proof
-  Needle type bits
-  Phillips
-  Hex tamper proof
-  Spanner nut
-  Phillips tamper proof
-  Tri-wing
-  Microstix
-  Torx plus socket
-  Torx
-  Nut
-  Spanner
-  Clutch
-  Ball hex
-  Square drive socket
-  Pentalobe tip
-  Torx tamper proof
-  Pozidriv
-  Torq
-  Spline
-  Star
-  Bihexagon socket
-  Tri-point tip

PLUG TYPE

	A	AC110~120V		D	AC220~240V		G	AC220~240V
	B	AC220~240V		E	AC110~120V		H	AC220~240V
	C	AC220~240V		F	AC220~240V		I	AC220~240V

CONTENTS



06
TOOL KITS



26
TEST INSTRUMENTS



50
SOLDERING &
DESOLDERING



80
FIBER OPTICS



96
CRIMPERS



112
PRECISION PLIERS &
CUTTERS



124
ELECTRICAL PLIERS &
CUTTERS



132
STRIPPERS



140
PUNCH DOWN TOOLS



143
ALIGNMENT TOOLS &
SCREWDRIVERS



160
HEX KEY WRENCHES



164
SOCKET WRENCHES



172
POWER TOOLS



177
ESD STATIC PROTECTION



180
VDE TOOLS



190
PRECISION TWEEZERS



195
MAGNIFIER & LAMP



199
KNIVES & SCISSORS



205
MISCELLANEOUS



215
INSTRUMENT CASES



221
TOOL CASES

229
INDEX



INNOVATION, QUALITY, SERVICE

Pro'sKit has been at the forefront of innovation and quality assurance. We've complied with international standard ISO 9001:2000 since 2002, built a complete in-house testing laboratory to provide the finest product and service.

Global Distributors

120+

Trademarks

65+

Countries

90+

Product Categories

22



TOOL KITS



NETWORK/TELECOM **7**

ELECTRONIC **15**

ELECTRICAL **12**

HOUSEHOLD **25**

Network/Telecom Tool Kits

PK-1938M Series Professional Telecom & Networking Tool Kit



- Computer & networking.
- Surveillance system.
- Installation & maintenance.
- Case size: 458x330x150mm(O.D.).



MT-7063



MT-7029N



MT-1707



MT-8001

PK-1938M

MODEL	CONTENTS	MODEL	CONTENTS
PM-736	Long Nose Plier (132mm)	9H075	Cable Tie
PM-737	Diagonal Cutting Plier (109mm)	AS-611	Wrist Strap 10FT
1PK-067DS	Dual Color Side Cutting Plier (165mm)	CP-3001D	Precision Wire Stripper (AWG 30/28/26/24/22/20)
1PK-108T	Reverse Action Tweezer (Self-Gripping) (165mm)	CP-3141A	Krone Impact Terminal Tool with Lock
1PK-125T	Super Fine Tip Straight Tweezer (120mm)	CP-376TR	4P/6P/8P Telecom Crimping Tool
1PK-3171	Spring Hook	CP-505	Universal Stripping Tool (UTP/STP, RG-59/6/7/11)
1PK-317N	Spring Hook	CP-751PA	7.5" Coax & Crimping Tool
1PK-H026	Adjustable Wrench - 6"	DK-2039	Utility Knife (3 Blades Self Loading)
9SD-201A	⊖ Pro-Soft Screwdriver (3.0x75mm)	DK-2040	Measuring Tape (3M/10FT)
9SD-201B	⊕ Pro-Soft Screwdriver (#0x75mm)	HW-121M	8PCS Folding Hex Key Set (1.5, 2, 2.5, 3, 4, 5, 6, 8mm)
9SD-202A	⊖ Pro-Soft Screwdriver (5x75mm)	MS-153C	Ø56mm Bulb Blower W/Brush
9SD-202B	⊕ Pro-Soft Screwdriver (#1x75mm)	MS-391	Inspection Mirror
9SD-207B	⊕ Pro-Soft Screwdriver (#2x100mm)	SR-338	Multi-Purpose Shears
9SD-200-T06H	⊕ Pro-Soft Screwdriver T06H 3.0x50mm	9PK-1900N-TP	Top Pallet For PK-1900N series
9SD-200-T07H	⊕ Pro-Soft Screwdriver T07H 3.0x50mm	9PK-1938-P	Pallet For PK-1938M series
9SD-200-T08H	⊕ Pro-Soft Screwdriver T08H 3.0x50mm	TC-756	Deluxe Aluminium Frame Tool Case
9SD-200-T09H	⊕ Pro-Soft Screwdriver T09H 3.0x50mm		Super Value Flexible Options
9SD-200-T10H	⊕ Pro-Soft Screwdriver T10H 3.0x75mm	PK-1938M1	PK-1938M+MT-7063
9SD-200-T15H	⊕ Pro-Soft Screwdriver T15H 4.0x75mm	PK-1938M2	PK-1938M+MT-7029N
9SD-200-M5	⊕ Pro-Soft Screwdriver 5mm	PK-1938M3	PK-1938M+MT-7063+MT-1707
9SD-200-M6	⊕ Pro-Soft Screwdriver 6mm	PK-1938M4	PK-1938M+MT-7063+MT-8001
908-607	Alignment Tool (200mm/2.0mm)	PK-1938M5	PK-1938M+MT-7029N+MT-1707+MT-8001

PK-4302AI/BM PC Networking Tool Kit



PK-4302AI



PK-4302BM

- Installation & repair.
- MIS engineer select.
- Case size: 458x330x150mm(O.D.).



MODEL	PK-4302AI	PK-4302BM
Voltage	110V-120V	220V-240V
Unit	Inch	Metric

MODEL	CONTENTS	MODEL	CONTENTS
1PK-067DS	Dual Color Side Cutting Plier (165mm)	6PK-501	Wire Stripper Tool
1PK-709DS	Dual Color Long Nose Plier (166mm)	CP-3141A	Krone Impact Terminal Tool with Lock
9CP-246D8P	Die Set for RJ45/8P8C	CP-080E	Wire Stripping Tool
9CP-346DC	Die Set for RG58/59/62/6	CP-371	CrimpPro Crimp Frame Only (236mm)
9CP-346DC2	Die Set for RG59/6,F Type	DK-2039	Utility Knife (3 Blades Self Loading)
9CP-346DG	Die Set for Fiber Optic Connector	DK-2040	Measuring Tape (3M/10FT)
9DP-S001	Pen Solder 63%	DP-366D	Desoldering Pump
9HW-002B	7 PCS Folding Type Hex Key Set	MT-1210	3 1/2 Compact Digital Multimeter
8PK-021NA	(Metric or inch)	MT-7031	Mini Lan Cable Tester
9SD-201A	⊖ Pro-Soft Screwdriver (3.0x75mm)	PD-2607	Ball Peen Hammer With Fiberglass Handle
9SD-201B	⊕ Pro-Soft Screwdriver (#0x75mm)	203-132G	Utility Component Storage Box(O.D.:180x97x42mm)
9SD-210A	⊖ Pro-Soft Screwdriver (5.5x100mm)	SI-130B-20	Ceramic Soldering Iron(220V-240V or 110V-120V)
9SD-210B	⊕ Pro-Soft Screwdriver (#1x100mm)	SI-130A-20	
9SD-200-M5	⊕ Pro-Soft Screwdriver	SR-332	All Purpose Snip (165mm)
9SD-200-I1	5mm(metric) or 3/16"(inch)	9PK-4302-P	Pallet for PK-4302 series
9SD-200-M6	⊕ Pro-Soft Screwdriver	9PK-4302-TP	Top Pallet for PK-4302 series
9SD-200-I2		6mm(metric) or 1/4"(inch)	9PK-730N

* For packing info please refer to the index at the back.

PK-4013 Network Installation Tool Kit

- Combination of essential tools for network installation and maintenance.
- Bag size: 340x222x60mm(O.D.).

MODEL	CONTENTS
1PK-067DS	Dual Color Side Cutting Plier (165mm)
6PK-501	Wire Stripper Tool
DK-2040	Measuring Tape (3M/10FT)
9FL-516	9PCS LED Flashlight
9SD-329H	Screwdriver Probe Voltage Tester
CP-148	Telecom Combi-Crimper/Plier
CP-302G	Precision Wire Stripper(AWG 20/18/16/14/12/10)
CP-3141	Impact Terminal Tool For Krone
CP-376KX	Professional Modular Crimps Strips & Cuts Tool (200mm)
DK-2039	Utility Knife (3 Blades Self Loading)
MT-7031	Mini Lan Cable Tester
SD-5101A	⊖ Line Color Screwdriver (3.0x 75mm)
SD-5101B	⊕ Line Color Screwdriver (#0 x 75mm)
SD-5107A	⊖ Line Color Screwdriver (6.0 x 100mm)
SD-5107B	⊕ Line Color Screwdriver (#2 x 100mm)
9ST-4013	Tool Bag

PK-2629 Telecom & Network Installer Tool Kit

- Complete kit allows the professional installer or amateur enthusiast to handle cabling, terminating and trouble shooting with ease.
- Bag size: 385x300x55mm(O.D.).

MODEL	CONTENTS
1PK-067DS	Dual Color Side Cutting Plier (165mm)
CP-148	Telecom Combi-Crimper/Plier
9SD-201A	⊖ Pro-Soft Screwdriver (3.0x75mm)
9SD-201B	⊕ Pro-Soft Screwdriver (#0x75mm)
CP-3141	Impact Terminal Tool For Krone
CP-376TR	4P/6P/8P Telecom Crimping Tool (190mm)
MT-1210	3 1/2 Compact Digital Multimeter
MT-7029N	Noise-filtering Network PoEToner & Probe Kit
9ST-2628	Tool Bag

PK-2633 Network Test Tool Kit



- Networking
- Installation & testing
- Basic troubleshooting
- Bag size: 255x180x50mm(O.D.).

MODEL	CONTENTS
6PK-501	Wire Stripper Tool
CP-3141	Impact Terminal Tool For Krone
CP-393	Pro-Crimper Modular Tool (160mm)
MT-7031	Mini Lan Cable Tester
PD-513	Utility Knife
SD-5102A	⊖ Line Color Screwdriver (5.0x75mm)
SD-5102B	⊕ Line Color Screwdriver (#1x75mm)
SD-5107A	⊖ Line Color Screwdriver (6.0x100mm)
SD-5107B	⊕ Line Color Screwdriver (#2x100mm)
SR-332	All Purpose Snip (165mm)
ST-33	Tool Bag

PK-2635 Network Installation Tool Kit



- Cat. 5/6/7 networking.
- Installation & testing.
- Basic troubleshooting.
- Bag size: 280x190x63.5mm(O.D.).

MODEL	CONTENTS
6PK-501	Wire Stripper Tool
CP-3141	Impact Terminal Tool For Krone
CP-335N	CAT.5/6/7 Modular Plug Crimping Tool
DK-2039	Utility Knife (3 Blades Self Loading)
MT-7031	Mini Lan Cable Tester
SD-5107A	⊖ Line Color Screwdriver (6.0 x 100mm)
SD-5107B	⊕ Line Color Screwdriver (#2 x 100mm)
9ST-PK2636	Tool Bag

PK-2636/PK-2637

Professional Network Installation Tool Kit



PK-2636



PK-2637



- PK-2636 - ideal for Cat. 5/6.
- PK-2637 - ideal for Cat. 5/6/7.
- Installation & testing.
- Advanced level.
- Bag size: 280x190x63.5mm(O.D.).

MODEL	CONTENTS
1PK-067DS	Dual Color Side Cutting Plier (165mm)
9SD-207A	⊖ Pro-Soft Screwdriver (6x100mm)
9SD-207B	⊕ Pro-Soft Screwdriver (#2x100mm)
CP-3141A	Krone Impact Terminal Tool with lock
DK-2039	Utility Knife (3 Blades Self Loading)
MT-7063	PoE & LAN Cable Tester
9ST-PK2636	Tool Bag
Super Value Flexible Options	
PK-2636	CP-376TR
PK-2637	CP-376TA

6PK-330K

Coaxial Crimping Tool Kit



- Networking.
- Carry case size: 305x210x58mm(O.D.).

CONTENTS	
Crimper tool	Rotary coaxial cable stripper
Round cable cutter	Screwdriver #1x125
DIE: .255", .213", .187", .068" (Hex) .319", .256", .213", .068" (Hex) .043" (SQ), .100", .213", .068", .137", .255" (Hex) .042" (SQ), .078", .151", .068", .128", .178" (Hex) .10", .128", .429" (Hex)	

Electrical Tool Kits

PK-2009A/B Professional Electrical & Mechanical Tool Set



PK-2009A



PK-2009B

- Electrical repair.
- Mechanical engineer.
- Air conditioning.
- Transportation maintain.
- Case size : 463x331x171mm(O.D.).



MODEL	PK-2009A	PK-2009B
Voltage	110V-120V	220V-240V
Unit	Inch	Metric

MODEL	CONTENTS	MODEL	CONTENTS
103-132C	Utility Component Storage Box	HW-609B	10PCS Electronic Combination Wrench (Metric or inch)
1PK-051DS	Dual Color Lineman's Plier (205mm)	HW-609A	
1PK-108T	Reverse Action Tweezer (Self-Gripping) (165mm)	9MS-153C	Ø56mm Bulb Blower
1PK-3171	Spring Hook	MS-391	Inspection Mirror
1PK-317N	Spring Hook	MT-1707	3-5/6 True RMS Multimeter
1PK-A001	10PCS Trimming Tool Set	NT-309	Smart Non-Contact Voltage Tester
1PK-H028	Adjustable Wrench - 8"	PD-2607	Ball Peen Hammer With Fiberglass Handle
HW-121M	Folding Type Hex Key Set (Metric or Inch)	PD-992	Electrician's Knife
8PK-021NA			PM-736
8PK-249	Snap Ring Plier Set (155mm)	PM-737	Diagonal Cutting Plier (109mm)
8PK-3161	7 in 1 Tool For AWG18/16/14/12/10	PM-754	Flat Nose Plier (135mm)
SI-130B-20	Ceramic Soldering Iron(220V-240V or 110V-120V)	PM-755	Bent Nose Plier (128mm)
SI-130A-20		PN-P010N	Slip-Channel Pump Plier 10" (254mm)
9DP-3616A	Square Scraper/Stainless Steel Brush	SD-081-P2	⊕ Precision Screwdriver(#00x50mm)
9DP-3616B	Slotted Shaft/Split 45 Lever	SD-081-P5	⊕ Precision Screwdriver(#0x75mm)
9DP-3616C	Tapered Reamer/Tapered Needle	SD-081-P7	⊕ Precision Screwdriver(#1x150mm)
9PK-153	Brush Black Handle	SD-081-S3	⊖ Precision Screwdriver(2.0x50mm)
9SD-201A	⊖ Pro-Soft Screwdriver (3.0x75mm)	SD-081-S6	⊖ Precision Screwdriver(2.4x75mm)
9SD-201B	⊕ Pro-Soft Screwdriver (#0x75mm)	SD-081-S7	⊖ Precision Screwdriver(3.0x100mm)
9SD-202A	⊖ Pro-Soft Screwdriver (5x75mm)	9PK-1900N-P	Pallet For PK-1900N series
9SD-202B	⊕ Pro-Soft Screwdriver (#1x75mm)	9PK-1900N-TP	Top Pallet For PK-1900N series
9SD-207A	⊖ Pro-Soft Screwdriver (6x100mm)	TC-2009	ABS Carrying Tool Case
9SD-207B	⊕ Pro-Soft Screwdriver (#2x100mm)	Super Value Flexible Options	
9SD-220A	⊖ Pro-Soft Screwdriver (6x40mm)	PK-2009A	8PK-SD016
9SD-220B	⊕ Pro-Soft Screwdriver (#2 6x40mm)	PK-2009B	HW-23801M
9SD-222A	⊖ Pro-Soft Screwdriver (8x150mm)		

PK-15308EM/PK-15308BM Field & Maintenance Kit



PK-15308EM



PK-15308BM

- Case size : 465x335x190mm(O.D.).



Heavy duty ABS tool Case
with Wheels & telescoping
handle



MODEL	PK-15308EM	PK-15308BM
Voltage	110V-120V	220V-240V
Unit	Inch	Metric

MODEL	CONTENTS	MODEL	CONTENTS
MT-1232	3-3/4 Autorange Digital Multimeter	PM-736	Long Nose Plier (132mm)
8PK-SD016	23 PCS 1/4" Driver Socket Set	PM-737	Diagonal Cutting Plier (109mm)
PD-2606	Heavy Duty Curved-Claw Hammer W/Fiberglass Handle	1PK-052DS	Dual Color Lineman's Plier (162mm)
1PK-H028	Adjustable Wrench 8"	1PK-067DS	Dual Color Side Cutting Plier (165mm)
908-609	IC Extractor	1PK-709DS	Dual Color Long Nose Plier (166mm)
PD-374	Hobby Vise(Jaw opening 40mm /width 60mm)	HW-229B	9 PCS Ball Point Long Arm Hex Key Set
PN-P010N	Slip-Channel Pump Pliers 254mm	HW-609B	10 PCS Electronic Combination Wrench (Metric or Inch)
SD-081-S3	⊖ Prosoft Precision Screwdriver(2.0X50mm)	HW-609A	5 PCS Needle File Set
SD-081-S6	⊖ Prosoft Precision Screwdriver(2.4X75mm)	8PK-605A	8PK-605A
SD-081-S7	⊖ Prosoft Precision Screwdriver(3.0X100mm)	SI-130B-20	Ceramic Soldering Iron (220V-240V or 110V-120V)
SD-081-P2	⊕ Prosoft Precision Screwdriver(#00X50mm)	SI-130A-20	9DP-031B
SD-081-P5	⊕ Prosoft Precision Screwdriver(#0X75mm)	9DP-S001	Desoldering Wick
SD-081-P7	⊕ Prosoft Precision Screwdriver(#1X150mm)	9MS-001	Pen Solder 63%
9SD-202A	⊖ Pro-Soft Screwdriver (5.0X75mm)	DK-2039	PVC Insulated Tape
9SD-202B	⊕ Pro-Soft Screwdriver (#1X75mm)	DK-2040	Utility Knife (3 Blades Self Loading)
9SD-210A	⊖ Pro-Soft Screwdriver (5.0X100mm)	SR-330	Measuring Tape 3M/10Ft
9SD-210B	⊕ Pro-Soft Screwdriver (#1X100mm)	DP-366D	All Purpose Snip
9SD-207A	⊖ Pro-Soft Screwdriver (6.0X100mm)	MS-035	Desoldering Pump
9SD-207B	⊕ Pro-Soft Screwdriver (#2X100mm)	9MS-153C	Flux Bottle (2 PCS/Pack)
9SD-217B	⊕ Pro-Soft Screwdriver (#2X250mm)	MS-323	Ø56mm Bulb Blower
9SD-220A	⊖ Pro-Soft Screwdriver (6.0X40mm)	MS-391	Telescopic Magnetic Pick Up Tool
9SD-220B	⊕ Pro-Soft Screwdriver (#2X40mm)	9PK-153	Inspection Mirror
1PK-125T	Fine Tip Straight Tweezer	8PK-3161	Brush Black Handle
203-132G	Utility Component Storage Box(O.D.:180x97x42mm)	9PK-15308-P	7 in 1 Tool For AWG18/16/14/12/10
TC-311	Heavy-Duty ABS Cases With Wheels And Telescoping Handle		Pallet For PK-15308

Electronic Tool Kits

PK-1990A/B Professional Electrician & Electronic Tool Kit



PK-1990A



PK-1990B

- Case size : 458x330x150mm(O.D.).

MODEL	PK-1990A	PK-1990B
Voltage	110V-120V	220V-240V
Unit	Inch	Metric



MODEL	CONTENTS	MODEL	CONTENTS
103-132C	Utility Component Storage Box	9SD-201A	⊖ Pro-Soft Screwdriver (3x75mm)
1PK-051DS	Dual Color Lineman's Plier(205mm)	9SD-201B	⊕ Pro-Soft Screwdriver (#0x75mm)
1PK-067DS	Dual Color Side Cutting Plier (165mm)	9SD-202A	⊖ Pro-Soft Screwdriver (5x75mm)
1PK-108T	Reverse Action Tweezer (Self-Gripping) (165mm)	9SD-202B	⊕ Pro-Soft Screwdriver (#1x75mm)
1PK-125T	Super Fine Tip Straight Tweezer (120mm)	9SD-207A	⊖ Pro-Soft Screwdriver (6x100mm)
1PK-317N	Spring Hook	9SD-207B	⊕ Pro-Soft Screwdriver (#2x100mm)
1PK-705	Diagonal Cutting Plier (128mm)	9SD-214B	⊕ Pro-Soft Screwdriver (#2x200mm)
1PK-706	Long Nose Plier (135mm)	AS-611	Wrist Strap 10FT
1PK-709DS	Dual Color Long Nose Plier (165mm)	DK-2040	Measuring Tape (3M/10FT)
1PK-A001	10PCS Trimming Tool Set	FL-516	9PCS LED Flashlight
1PK-H026	Adjustable Wrench - 6"	HW-121M	Folding Type Hex Key Set (Metric or inch)
8PK-3161	7 in 1 Tool For AWG18/16/14/12/10	8PK-021NA	10PCS Electronic Combination Wrench (Metric or inch)
8PK-366N-G	Desoldering Pump	HW-609B	Ø56mm Bulb Blower
8PK-SD016	23PCS 1/4" Driver Socket Set	HW-609A	Inspection Mirror
908-609	IC Extractor	MS-391	Heavy Duty Curved-Claw Hammer W/Fiberglass Handle
9DP-031B	Desoldering Wick(2.0Mm)Length(1.5M)	PD-2606	Flat Nose Plier (135mm)
9DP-3616A	Square Scraper/Stainless Steel Brush	PM-754	Bent Nose Plier (128mm)
9DP-3616B	Slotted Shaft/Split 45 Lever	PM-755	Slip Joint Plier 6" (154mm)
9DP-3616C	Tapered Reamer/Tapered Needle	PN-086N	3.6V Li-ion USB Grinder Set
9DP-S001	Pen Solder 63%	PT-5206U	⊕ Precision Screwdriver(#00 x 50mm)
9H003	3 Prong Holder	SD-081-P2	⊕ Precision Screwdriver(#0 x 75mm)
9K003A-1	Needle File Flat	SD-081-P5	⊕ Precision Screwdriver(#1 x 150mm)
9K003B-1	Needle File Round	SD-081-P7	⊖ Precision Screwdriver(2.0 x 50mm)
9K003C-1	Needle File Square	SD-081-S3	⊖ Precision Screwdriver(2.4 x 75mm)
9K003D-1	Needle File Triangle	SD-081-S6	⊖ Precision Screwdriver(3.0 x 100mm)
9K003E-1	Needle File Semicircle	SD-081-S7	Ceramic Soldering Iron(220V-240V or 110V-120V)
9MS-001	PVC Insulated Tape	SI-130B-20	Pallet For PK-1900N series
9PK-153	Brush	SI-130A-20	Top Pallet For PK-1900N series
9S004	Heat Sink	9PK-1900N-P	
9SD-200-M5	⊕ Pro-Soft Screwdriver 5mm(metric) or 3/16"(inch)	9PK-1900N-TP	
9SD-200-I1		TC-756	Deluxe Aluminium Frame Tool Case
9SD-200-M6	⊕ Pro-Soft Screwdriver 6mm(metric) or 1/4"(inch)		
9SD-200-I2			

PK-1900NA/NB Professional Electronic Repair Tool Kit



PK-1900NA



PK-1900NB

• Case size: 458x330x150mm(O.D.).



MODEL	PK-1900NA	PK-1900NB
Voltage	110V-120V	220V-240V
Unit	Inch	Metric

MODEL	CONTENTS	MODEL	CONTENTS
103-132C	Utility Component Storage Box (O.D.:165x95x45mm)	9PK-153	Brush
1PK-051DS	Dual Color Lineman's Plier(205mm)	SH-1025	Soldering Tip Cleaner
1PK-125T	Super Fine Tip Straight Tweezer (120mm)	AS-611	Wrist Strap 10FT
1PK-H026	Adjustable Wrench - 6"	DK-2039	Utility Knife (3 Blades Self Loading)
8PK-3161	7 in 1 Tool For AWG18/16/14/12/10	HW-121M	Folding Type Hex Key Set (Metric or inch)
8PK-366N-G	Desoldering Pump	8PK-021NA	10PCS Electronic Combination Wrench (Metric or inch)
908-609	IC Extractor	HW-609B	10PCS Electronic Combination Wrench (Metric or inch)
9DP-3616A	Square Scraper/Stainless Steel Brush	HW-609A	10PCS Electronic Combination Wrench (Metric or inch)
9DP-3616B	Slotted Shaft/Split 45 Lever	MS-035	Flux Bottle (Unit:2PCS/Pack)
9DP-3616C	Tapered Reamer/Tapered Needle	9MS-153C	Ø56mm Bulb Blower
9DP-S001	Pen Solder 63%	MT-1210	3 1/2 Compact Digital Multimeter
9H003	3 Prong Holder	NT-305N	Contact Voltage Tester
9K003A-1	Needle File Flat	PD-374	Hobby Vise (Jaw opening 40mm /width 60mm)
9K003B-1	Needle File Round	PM-736	Long Nose Plier (132mm)
9K003C-1	Needle File Square	PM-737	Diagonal Cutting Plier (109mm)
9K003D-1	Needle File Triangle	PM-754	Flat Nose Plier (135mm)
9K003E-1	Needle File Semicircle	PM-755	Bent Nose Plier (128mm)
9MS-001	PVC Insulated Tape	PT-5206U	3.6V Li-ion USB Grinder Set
9SD-200-M5	Pro-Soft Screwdriver 5mm(metric) or 3/16"(inch)	SD-081-P2	⊕ Precision Screwdriver(#00 x 50mm)
9SD-200-I1	Pro-Soft Screwdriver 5mm(metric) or 3/16"(inch)	SD-081-P5	⊕ Precision Screwdriver(#0 x 75mm)
9SD-200-M6	Pro-Soft Screwdriver 6mm(metric) or 1/4"(inch)	SD-081-P7	⊕ Precision Screwdriver(#1 x 150mm)
9SD-200-I2	Pro-Soft Screwdriver 6mm(metric) or 1/4"(inch)	SD-081-S3	⊖ Precision Screwdriver(2.0 x 50mm)
9SD-200-T10H	Pro-Soft Screwdriver (T10H 3.0x75mm)	SD-081-S6	⊖ Precision Screwdriver(2.4 x 75mm)
9SD-200-T15H	Pro-Soft Screwdriver (T15H 4.0x75mm)	SD-081-S7	⊖ Precision Screwdriver(3.0 x 100mm)
9SD-201A	Pro-Soft Screwdriver (3.0x75mm)	SI-130B-20	Ceramic Soldering Iron(220V-240V or 110V-120V)
9SD-201B	Pro-Soft Screwdriver (#0x75mm)	SI-130A-20	Ceramic Soldering Iron(220V-240V or 110V-120V)
9SD-202A	Pro-Soft Screwdriver (5x75mm)	SR-336	Multi Purpose Scissors
9SD-202B	Pro-Soft Screwdriver (#1x75mm)	9PK-1900N-P	Pallet For PK-1900N series
9SD-207A	Pro-Soft Screwdriver (6x100mm)	9PK-1900N-TP	Top Pallet For PK-1900N series
9SD-207B	Pro-Soft Screwdriver (#2x100mm)		
9SD-217B	Pro-Soft Screwdriver (#2x250mm)	TC-756	Deluxe Aluminium Frame Tool Case

PK-1700NA/NB

Electronics Master Kit



PK-1700NA



PK-1700NB

- Case size : 458x330x150mm(O.D.).



MODEL	PK-1700NA	PK-1700NB
Voltage	110V-120V	220V-240V
Unit	Inch	Metric

MODEL	CONTENTS	MODEL	CONTENTS
103-132C	Utility Component Storage Box	9SD-201A	⊖ Pro-Soft Screwdriver (3x75mm)
1PK-051DS	Dual Color Lineman's Plier(205mm)	9SD-201B	⊕ Pro-Soft Screwdriver (#0x75mm)
1PK-067DS	Dual Color Side Cutting Plier (165mm)	9SD-202A	⊖ Pro-Soft Screwdriver (5x75mm)
1PK-108T	Reverse Action Tweezer (Self-Gripping) (165mm)	9SD-202B	⊕ Pro-Soft Screwdriver (#1x75mm)
1PK-709DS	Dual Color Long Nose Plier (166mm)	9SD-207A	⊖ Pro-Soft Screwdriver (6x100mm)
1PK-H026	Adjustable Wrench - 6"	9SD-207B	⊕ Pro-Soft Screwdriver (#2x100mm)
8PK-3161	7 In 1 Crimping Tool	9SD-220A	⊖ Pro-Soft Screwdriver (6x40mm)
8PK-366N-G	Desoldering Pump	9SD-220B	⊕ Pro-Soft Screwdriver (#2x40mm)
908-609	IC Extractor	HW-121M	Folding Type Hex Key Set (Metric or inch)
9DP-031B	Desoldering Wick(2.0mm)Length(1.5M)	8PK-021NA	
9DP-3616A	Square Scraper/Stainless Steel Brush	SH-1025	Soldering Tip Cleaner
9DP-3616B	Slotted Shaft/Split 45 Lever	DK-2039	Utility Knife (3 Blades Self Loading)
9DP-3616C	Tapered Reamer/Tapered Needle	DK-2040	Measuring Tape (3M/10FT)
9DP-S001	Pen Solder 63%	MS-391	Inspection Mirror
9H003	3 Prong Holder	NT-305N	Contact Voltage Tester
9HW-7106B	Double Open End Wrench 6x7mm	PD-2606	Heavy Duty Curved-Claw Hammer W/Fiberglass Handle
9HW-7108B	Double Open End Wrench 8x10mm	PM-736	Long Nose Plier (132mm)
9HW-7111B	Double Open End Wrench 11x13mm	PM-737	Diagonal Cutting Plier (109mm)
9HW-7112B	Double Open End Wrench 12x14mm	PM-755	Bent Nose Plier (128mm)
9HW-7114B	Double Open End Wrench 14x17mm	PN-P010N	Slip-Channel Pump Plier 10" (254mm)
9HW-7117B	Double Open End Wrench 17x19mm	SD-081-P2	⊕ Precision Screwdriver(#00 x 50mm)
9K003A-1	Needle File Flat	SD-081-P5	⊕ Precision Screwdriver(#0 x 75mm)
9K003B-1	Needle File Round	SD-081-P7	⊕ Precision Screwdriver(#1 x 150mm)
9K003C-1	Needle File Square	SD-081-S3	⊖ Precision Screwdriver(2.0 x 50mm)
9K003D-1	Needle File Triangle	SD-081-S6	⊖ Precision Screwdriver(2.4 x 75mm)
9K003E-1	Needle File Semicircle	SD-081-S7	⊖ Precision Screwdriver(3.0 x 100mm)
9MS-001	PVC Insulated Tape	SI-130B-20	Ceramic Soldering Iron(220V-240V or 110V-120V)
9PK-153	Brush Black Handle	SI-130A-20	
9SD-200-M5	⊕ Pro-Soft Screwdriver 5mm(metric) or 3/16"(inch)	SR-336	Multi Purpose Scissors
9SD-200-I1		9PK-1900N-P	Pallet For PK-1900N series
9SD-200-M6	⊕ Pro-Soft Screwdriver 6mm(metric) or 1/4"(inch)	9PK-1900N-TP	Top Pallet For PK-1900N series
9SD-200-I2		TC-756	Deluxe Aluminium Frame Tool Case

PK-1305NA/NB

Professional Engineer Repair Tool Set



PK-1305NA



PK-1305NB

• Case size: 458x330x150mm(O.D.).



MODEL	PK-1305NA	PK-1305NB
Voltage	110V-120V	220V-240V
Unit	Inch	Metric

MODEL	CONTENTS	MODEL	CONTENTS
103-132C	Utility Component Storage Box	SH-1025	Soldering Tip Cleaner
1PK-108T	Reverse Action Tweezer (Self-Gripping) (165mm)	DK-2039	Utility Knife (3 Blades Self Loading)
1PK-H026	Adjustable Wrench - 6"	DK-2040	Measuring Tape (3M/10FT)
8PK-366N-G	Desoldering Pump	MT-1210	3 1/2 Compact Digital Multimeter
9DP-3616A	Square Scraper/Stainless Steel Brush	PM-736	Long Nose Plier (132mm)
9DP-3616B	Slotted Shaft/Split 45 Lever	PM-737	Diagonal Cutting Plier (109mm)
9DP-3616C	Tapered Reamer/Tapered Needle	PM-754	Flat Nose Plier (135mm)
9DP-S001	Pen Solder 63%	PM-755	Bent Nose Plier (128mm)
9K003A-1	Needle File Flat	SD-081-P2	⊕ Precision Screwdriver (#0 x 50mm)
9K003B-1	Needle File Round	SD-081-P5	⊕ Precision Screwdriver (#0 x 75mm)
9MS-001	PVC Insulated Tape	SD-081-P7	⊕ Precision Screwdriver (#1 x 150mm)
9MS-153C	Ø56mm Bulb Blower	SD-081-S3	⊖ Precision Screwdriver (2.0 x 50mm)
9PK-153	Brush Black Handle	SD-081-S6	⊖ Precision Screwdriver (2.4 x 75mm)
9SD-200-M5	⊕ Pro-Soft Screwdriver 5mm(metric) or 3/16"(inch)	SD-081-S7	⊖ Precision Screwdriver (3.0 x 100mm)
9SD-200-I1	⊕ Pro-Soft Screwdriver 6mm(metric) or 1/4"(inch)	HW-121M	Folding Type Hex Key Set (Metric or inch)
9SD-200-M6	⊕ Pro-Soft Screwdriver 6mm(metric) or 1/4"(inch)	8PK-021NA	Ceramic Soldering Iron(220V-240V or 110V-120V)
9SD-201A	⊖ Pro-Soft Screwdriver (3x75mm)	SI-130B-20	
9SD-201B	⊕ Pro-Soft Screwdriver (#0x75mm)	SI-130A-20	
9SD-202A	⊖ Pro-Soft Screwdriver (5x75mm)	SR-330	All Purpose Snip (165mm)
9SD-202B	⊕ Pro-Soft Screwdriver (#1x75mm)	9PK-1900N-P	Pallet For PK-1900N series
9SD-207A	⊖ Pro-Soft Screwdriver (6x100mm)	9PK-1900N-TP	Top Pallet For PK-1900N series
9SD-207B	⊕ Pro-Soft Screwdriver (#2x100mm)	TC-756	Deluxe Aluminium Frame Tool Case

PK-15307BM/EI Electronic Tool Kit



PK-15307BM



PK-15307EI

- Case size: 458x330x150mm(O.D.).



MODEL	PK-15307EI	PK-15307BM
Voltage	110V-120V	220V-240V
Unit	Inch	Metric

MODEL	CONTENTS	MODEL	CONTENTS
1PK-051DS	Dual Color Lineman's Plier (205mm)	SH-1025	Soldering Tip Cleaner
1PK-067DS	Dual Color Side Cutting Plier (165mm)	CP-108	Wire Stripper Cutter (Stripping Wire from 10-30 AWG)
1PK-108T	Reverse Action Tweezer (Self-Gripping) (165mm)	DK-2039	Utility Knife (3 Blades Self Loading)
1PK-125T	Super Fine Tip Straight Tweezer (120mm)	DK-2040	Measuring Tape (3M/10FT)
1PK-709DS	Dual Color Long Nose Plier (166mm)	DP-366P	Desoldering Pump
1PK-H026	Adjustable Wrench - 6"	9HW-002B	Folding Type Hex Key Set (Metric or inch)
8PK-605A	5 PCS Needle File Set	8PK-021NA	
908-609	IC Extractor	HW-609B	10PCS Electronic Combination Wrench (Metric or inch)
9DP-3616A	Square Scraper/Stainless Steel Brush	HW-609A	
9DP-3616B	Slotted Shaft/Split 45 Lever	MS-035	Flux Bottle (Unit:2PCS/Pack)
9DP-3616C	Tapered Reamer/Tapered Needle	MT-1210	3 1/2 Compact Digital Multimeter
9DP-S001	Pen Solder 63%	PD-374	Hobby Vise (Jaw opening 40mm /width 60mm)
SI-130B-20	Ceramic Soldering Iron(220V-240V or 110V-120V)	PM-736	Long Nose Plier (132mm)
SI-130A-20		PM-737	Diagonal Cutting Plier (109mm)
9MS-153C	Ø56mm Bulb Blower	PN-086N	Slip Joint Plier 6" (154mm)
9PK-153	Brush	203-132G	Utility Component Storage Box(O.D.:180x97x42mm)
9S004	Heat Sink	SD-081-P2	⊕ Precision Screwdriver(#00 x 50mm)
9SD-201A	⊖ Pro-Soft Screwdriver (3x75mm)	SD-081-P5	⊕ Precision Screwdriver(#0 x 75mm)
9SD-201B	⊕ Pro-Soft Screwdriver (#0x75mm)	SD-081-P7	⊕ Precision Screwdriver(#1 x 150mm)
9SD-202A	⊖ Pro-Soft Screwdriver (5x75mm)	SD-081-S3	⊖ Precision Screwdriver(2.0 x 50mm)
9SD-202B	⊕ Pro-Soft Screwdriver (#1x75mm)	SD-081-S6	⊖ Precision Screwdriver(2.4 x 75mm)
9SD-207A	⊖ Pro-Soft Screwdriver (6x100mm)	SD-081-S7	⊖ Precision Screwdriver(3.0 x 100mm)
9SD-207B	⊕ Pro-Soft Screwdriver (#2x100mm)	SR-330	All Purpose Snip (165mm)
9SD-217B	⊕ Pro-Soft Screwdriver (#2x250mm)	9PK-15307-P	Pallet for PK-15307
9SD-220A	⊖ Pro-Soft Screwdriver (6x40mm)	9PK-15307-TP	Top Pallet for PK-15307
9SD-220B	⊕ Pro-Soft Screwdriver (#2x40mm)	TC-756	Deluxe Aluminium Frame Tool Case

PK-710KA/KB Basic Electronic Tool Kit



PK-710KA



PK-710KB

• Case size : 330x250x110mm(O.D.).



MODEL	PK-710KA	PK-710KB
Voltage	110V-120V	220V-240V
Unit	Inch	Metric

MODEL	CONTENTS
1PK-067DS	Dual Color Side Cutting Plier (165mm)
1PK-125T	Super Fine Tip Straight Tweezer (120mm)
1PK-709DS	Dual Color Long Nose Plier (166mm)
8PK-3161	7 in 1 Tool For AWG18/16/14/12/10
8PK-366N-G	Desoldering Pump
9DP-031B	Desoldering Wick(2.0mmx1.5M)
9DP-3616A	Square Scraper/Stainless Steel Brush
9DP-3616B	Slotted Shaft/Split 45 Lever
9DP-3616C	Tapered Reamer/Tapered Needle
9DP-S001	Pen Solder 63%
9K003A-1	Needle File Flat
9K003B-1	Needle File Round
9MS-001	PVC Insulated Tape
9SD-201A	⊖ Pro-Soft Screwdriver (3x75mm)
9SD-201B	⊕ Pro-Soft Screwdriver (#0x75mm)
9SD-202A	⊖ Pro-Soft Screwdriver (5x75mm)
9SD-202B	⊕ Pro-Soft Screwdriver (#1x75mm)
9SD-207A	⊖ Pro-Soft Screwdriver (6x100mm)
9SD-207B	⊕ Pro-Soft Screwdriver (#2x100mm)
DK-2039	Utility Knife (3 Blades Self Loading)
HW-121M	Folding Type Hex Key Set (Metric or inch)
8PK-021NA	
MT-1210	3 1/2 Compact Digital Multimeter
PM-736	Long Nose Plier (132mm)
PM-737	Diagonal Cutting Plier (109mm)
SI-130B-20	Ceramic Soldering Iron(220V-240V or 110V-120V)
SI-130A-20	
SR-336	Multi Purpose Scissor
9PK-710P	Deluxe Tool Case W/2 Pallets

PK-2002A/B Technician's Tool Kit



PK-2002A



PK-2002B

• Bag size : 385x300x55mm(O.D.).



MODEL	PK-2002A	PK-2002B
Voltage	110V-120V	220V-240V
Unit	Inch	Metric

MODEL	CONTENTS
1PK-052DS	Dual Color Lineman's Plier (162mm)
1PK-108T	Reverse Action Tweezer (Self-Gripping) (165mm)
1PK-125T	Super Fine Tip Straight Tweezer (120mm)
1PK-H028	Adjustable Wrench - 8"
8PK-2061	6PCS Electronic Screwdriver Set
8PK-3161	7 in 1 Tool For AWG18/16/14/12/10
908-609	IC Extractor
9DP-3616A	Square Scraper/Stainless Steel Brush
9DP-3616B	Slotted Shaft/Split 45 Lever
9DP-3616C	Tapered Reamer/Tapered Needle
9DP-S001	Pen Solder 63%
8PK-605A	5 PCS Needle File Set
9PK-153	Brush
9SD-200-M5	⊖ Pro-Soft Screwdriver 5mm(metric) or 3/16"(inch)
9SD-200-I1	
9SD-200-M6	⊖ Pro-Soft Screwdriver 6mm(metric) or 1/4"(inch)
9SD-200-I2	
HW-121M	Folding Type Hex Key Set (Metric or inch)
8PK-021NA	
AS-611	Wrist Strap 10FT
DK-2039	Utility Knife (3 Blades Self Loading)
DP-366P	Desoldering Pump
FL-516	9PCS LED Flashlight
PD-610	PLCC Extractor
PM-736	Long Nose Plier (132mm)
PM-737	Diagonal Cutting Plier (109mm)
PM-754	Flat Nose Plier (135mm)
PM-755	Bent Nose Plier (128mm)
SD-9820	10 in 1 Ratchet Screwdriver Kit
SI-130B-20	
SI-130A-20	Ceramic Soldering Iron(220V-240V or 110V-120V)
5ST-13-SS	Shoulder Strap
9ST-13	Tool Bag

PK-813A/B Electrical Appliances Repair Tool Kit**PK-813A****PK-813B**

- Compact size.
- Multifunction.
- Basic tool kit for home appliances repair, comes with all essential tools.
- Bag size : 228x340x63.5mm(O.D.).



MODEL	PK-813A	PK-813B
Voltage	110V-120V	220V-240V
Unit	Inch	Metric

PK-616A/B Professional Electronic Tool Kit**PK-616A****PK-616B**

- Bag size : 385x300x55mm(O.D.).



MODEL	PK-616A	PK-616B
Voltage	110V-120V	220V-240V
Unit	Inch	Metric

MODEL	CONTENTS
1PK-052DS	Dual Color Lineman's Plier (162mm)
1PK-067DS	Dual Color Side Cutting Plier (165mm)
1PK-125T	Super Fine Tip Straight Tweezer (120mm)
1PK-709DS	Dual Color Long Nose Plier (166mm)
1PK-H026	Adjustable Wrench - 6"
8PK-366N-G	Desoldering Pump
908-607	Alignment Tool (200mm/2.0mm)
9DP-031B	Desoldering Wick(2.0mmx1.5M)
9DP-S001	Pen Solder 63%
9K003A-1	Needle File Flat
9K003B-1	Needle File Round
9MS-001	PVC Insulated Tape
9SD-200-M5	Pro-Soft Screwdriver 5mm(metric) or 3/16"(inch)
9SD-200-I1	Pro-Soft Screwdriver 6mm(metric) or 1/4"(inch)
9SD-200-M6	Pro-Soft Screwdriver 6mm(metric) or 1/4"(inch)
9SD-200-I2	Pro-Soft Screwdriver (3x75mm)
9SD-201A	Pro-Soft Screwdriver (#0x75mm)
9SD-201B	Pro-Soft Screwdriver (#0x75mm)
9SD-202A	Pro-Soft Screwdriver (5x75mm)
9SD-202B	Pro-Soft Screwdriver (#1x75mm)
9SD-207A	Pro-Soft Screwdriver (6x100mm)
9SD-207B	Pro-Soft Screwdriver (#2x100mm)
9SD-213B	Pro-Soft Screwdriver (#2x150mm)
SI-130B-20	Ceramic Soldering Iron(220V-240V or 110V-120V)
SI-130A-20	Ceramic Soldering Iron(220V-240V or 110V-120V)
9ST-PK813	Tool Bag

MODEL	CONTENTS
1PK-052DS	Dual Color Lineman's Plier (162mm)
1PK-125T	Super Fine Tip Straight Tweezer (120mm)
8PK-2061	6PCS Electronic Screwdriver Set
908-609	IC Extractor
9DP-S002	Lead Free Solder Dispenser
9K003A-1	Needle File Flat
9K003B-1	Needle File Round
9MS-001	PVC Insulated Tape
AS-611	Wrist Strap 10FT
DP-366P	Desoldering Pump
MT-1210	3 1/2 Compact Digital Multimeter
PM-737	Diagonal Cutting Plier (109mm)
PM-746	Needle Nose Plier (150mm)
HW-121M	Folding Type Hex Key Set (Metric or inch)
8PK-021NA	Folding Type Hex Key Set (Metric or inch)
SD-5101A	Line Color Screwdriver (3x 75mm)
SD-5101B	Line Color Screwdriver (#0 x 75mm)
SD-5102A	Line Color Screwdriver (5 x 75mm)
SD-5102B	Line Color Screwdriver (#1 x 75mm)
SD-5107A	Line Color Screwdriver (6 x 100mm)
SD-5107B	Line Color Screwdriver (#2 x 100mm)
9108	Line Color Screwdriver Nut 3/16"
9109	Line Color Screwdriver Nut 1/4"
SI-130B-20	Ceramic Soldering Iron(220V-240V or 110V-120V)
SI-130A-20	Ceramic Soldering Iron(220V-240V or 110V-120V)
9ST-13	Tool Bag

PK-2088A/B/BA

PC Service Kit



PK-2088A/B



PK-2088BA

• Bag size: 228x340x63.5mm(O.D.).



PK-2088A/B



PK-2088BA
with 8PK-AS07-1

MODEL	PK-2088A	PK-2088B/BA
Voltage	110V-120V	220V-240V
Unit	Inch	Metric

MODEL	CONTENTS
1PK-108T	Reverse Action Tweezer (Self-Gripping) (165mm)
1PK-125T	Super Fine Tip Straight Tweezer (120mm)
1PK-H026	Adjustable Wrench - 6"
8PK-3161	7 in 1 Tool For AWG18/16/14/12/10
8PK-366N-G	Desoldering Pump
908-609	IC Extractor
9DP-S001	Pen Solder 63%
9S004	Heat Sink
9SD-200-M5	● Pro-Soft Screwdriver 5mm(metric) or 3/16"(inch)
9SD-200-I1	
9SD-200-M6	● Pro-Soft Screwdriver 6mm(metric) or 1/4"(inch)
9SD-200-I2	
9SD-200-T10H	⊕ Pro-Soft Screwdriver T10H (3.0x75mm)
9SD-200-T15H	⊕ Pro-Soft Screwdriver T15H (4.0x75mm)
9SD-201A	⊖ Pro-Soft Screwdriver (3x75mm)
9SD-201B	⊕ Pro-Soft Screwdriver (#0x75mm)
9SD-202A	⊖ Pro-Soft Screwdriver (5x75mm)
9SD-202B	⊕ Pro-Soft Screwdriver (#1x75mm)
AS-501A	Long Handle Static Brush (40mm)
AS-611	Wrist Strap 10FT
DP-033A	Anti-Hot Desoldering Wick
PD-610	PLCC Extractor
PM-736	Long Nose Plier (132mm)
PM-737	Diagonal Cutting Plier (109mm)
SD-081-T5H	⊕ Precision Screwdriver For Star Type W/Temper Proof T5H
SD-081-T6H	⊕ Precision Screwdriver For Star Type W/Temper Proof T6H
SD-081-T9H	⊕ Precision Screwdriver For Star Type W/Temper Proof T9H
SI-130B-20	
SI-130A-20	Ceramic Soldering Iron(220V-240V or 110V-120V)
9ST-PK2088-1	Tool Bag
Super Value Flexible Options	
PK-2088BA	PK-2088B+8PK-AS07-1

PK-612NA/NB

Electrician Repair Tool Kit



PK-612NA



PK-612NB

• Bag size: 340x222x60mm(O.D.).



MODEL	PK-612NA	PK-612NB
Voltage	110V-120V	220V-240V
Unit	Inch	Metric

MODEL	CONTENTS
1PK-125T	Super Fine Tip Straight Tweezer (120mm)
1PK-H026	Adjustable Wrench - 6"
8PK-3161	7 in 1 Tool For AWG18/16/14/12/10
8PK-366N-G	Desoldering Pump
908-607	Alignment Tool (200mm/2.0mm)
908-609	IC Extractor
9DP-S001	Pen Solder 63%
9H003	3 Prong Holder
9PK-153	Brush
9SD-201A	⊖ Pro-Soft Screwdriver (3x75mm)
9SD-201B	⊕ Pro-Soft Screwdriver (#0x75mm)
9SD-202A	⊖ Pro-Soft Screwdriver (5x75mm)
9SD-202B	⊕ Pro-Soft Screwdriver (#1x75mm)
9SD-207A	⊖ Pro-Soft Screwdriver (6x100mm)
9SD-207B	⊕ Pro-Soft Screwdriver (#2x100mm)
HW-221M	
8PK-021NA	Folding Type Hex Key Set (Metric or inch)
DK-2039	Utility Knife (3 Blades Self Loading)
PM-736	Long Nose Plier (132mm)
PM-737	Diagonal Cutting Plier (109mm)
SI-130B-20	
SI-130A-20	Ceramic Soldering Iron(220V-240V or 110V-120V)
ST-23	Tool Bag

* For packing info please refer to the index at the back.

PK-810A/B Basic PC & NB Repair Tool Set



PK-810A



PK-810B



- Bag size: 180x305 x67mm(O.D.).

MODEL	CONTENTS	MODEL	CONTENTS
1PK-036S	Long Nose Plier	9PK-153	Brush Black Handle
1PK-037S	Diagonal Cutting Plier	9S004	Heat Sink
1PK-125T	Tweezer	9SD030-2	8Pcs Bits Pack
1PK-H026	Adjustable Wrench	9SD-202A	⊖ Pro-Soft Screwdriver (5x75mm)
8PK-3161	Stripper (7 in 1)	9SD-202B	⊕ Pro-Soft Screwdriver (#1x75mm)
908-609	IC Extractor	9SD-2320M-EXT	Extension Bar 100mm
9DP-031B	Desoldering Wick	9SD-9857M-HAN	Screwdriver Handle
9DP-3616A	Stainless Steel Brush	DP-366D	Desoldering Pump
9DP-3616B	Slotted Shaft	SI-130B-20	Ceramic Soldering Iron (220V-240V or 110V-120V)
9DP-3616C	Tapered Needle	SI-130A-20	
9DP-S001	Pen Solder 63%	9ST-PK810	Tool Bag
9H003	3 Prong Holder		

PK-2086A/B Basic Electrical Kit



PK-2086A



PK-2086B



- Bag size: 340x222 x60mm(O.D.).

MODEL	CONTENTS	MODEL	CONTENTS
1PK-052	Lineman's Plier	9SD-207B	⊕ Pro-soft Screwdriver (#2x100mm)
1PK-067	Side Cutting Plier	9SD-210A	⊖ Pro-soft Screwdriver (5x100mm)
1PK-709	Long Nose Plier	9SD-210B	⊕ Pro-soft Screwdriver (#1x100mm)
1PK-H026	Adjustable Wrench	SI-129B-60	Soldering Iron 220V-240V or 110V-120V
9DP-031B	Desoldering Wick	SI-130A-20	
9DP-S001	Pen Solder 63%	1PK-125T	Fine Tip Straight Tweezer
9SD-205A	⊖ Pro-soft Screwdriver (3x100mm)	9ST-23	Zipper Carrying Bag
9SD-205B	⊕ Pro-soft Screwdriver (#0x100mm)		

1PK-635 Precision Electronic Tool Kit



- Bag size: 130x207 x35mm(O.D.).

MODEL	CONTENTS
1PK-125T	Fine Tip Straight Tweezer
1PK-258A	Side Cutter 125mm
PM-736	Long Nose Plier 132mm
SD-081-P2	⊕ Precision Screwdriver (#00x50mm)
SD-081-P3	⊕ Precision Screwdriver (#0x50mm)
SD-081-P4	⊕ Precision Screwdriver (#1x50mm)
SD-081-S2	⊖ Precision Screwdriver (1.6x50mm)
SD-081-S3	⊖ Precision Screwdriver (2.0x50mm)
SD-081-S4	⊖ Precision Screwdriver (2.4x50mm)
SD-081-S5	⊖ Precision Screwdriver (3.0x50mm)
9ST-43	Tool Bag

PK-2079 ESD Precision Tool Kit



SK7 Material



- ESD safe.
- Bag size: 340x222 x60mm(O.D.).

MODEL	CONTENTS	MODEL	CONTENTS
1PK-102-E	Long Nose Plier	1PK-25P-E	Micro Cutting Plier
1PK-104-E	Flat Nose Plier	TZ-100A/B/C/D	4 PCS Conductive Tweezer Set
1PK-105-E	Bent Nose Plier	8PK-611	Wrist Strap 10Ft
1PK-209	Clean Cut Micro Nipper	9ST-23	Tool bag
SD-083-P2	⊕ ESD Precision Screwdriver (#00x50mm)		
SD-083-P3	⊕ ESD Precision Screwdriver (#0x50mm)		
SD-083-P4	⊕ ESD Precision Screwdriver (#1x50mm)		
SD-083-S3	⊖ ESD Precision Screwdriver (2.0x50mm)		
SD-083-S4	⊖ ESD Precision Screwdriver (2.4x50mm)		
SD-083-S5	⊖ ESD Precision Screwdriver (3.0x50mm)		

PK-2061

Solar MC3 & MC4 Crimping Tool Kit



- Universal solar cable stripper
- Heavy duty Forged Cable Cutter with high leverage Jaw and shear blade
- Includes 2 pcs MC4 and MC4 PLUS open-end spanner and unlocking tool
- Prosoft screwdrivers for PV junction box installation
- Bag size: 280x197x70mm(O.D.).

MODEL	CONTENTS
8PK-A202	Forging Cable Cutter (160mm)
9HW-MC4	2 PCS open-end spanner and unlocking tool (MC4 and MC4 PLUS)
89402A	⊖ Pro-Soft Screwdriver (-5 5x75mm)
89407B	⊕ Pro-Soft Screwdriver (+#2x100mm)
CP-246	Solar Cable Stripper
CP-3006F	Parallel Action Crimping Tool (Frame Only)
CP-5S1D	⊖ Die Set For MC 3 Solar Connector (Multi-Contact) & 2.5/4.0/6.0 mm ² (AWG 14/12/10) Solar Cable
CP-5S2D	⊕ Die Set For MC 4 Solar Connector (Multi-Contact) & 2.5/4.0/6.0 mm ² (AWG 14/12/10) Solar Cable
9Z-940KP	Tool Bag

PK-301/PK-324

Mini House Hold Tool Kit/Mini USB Soldering Iron Kit



PK-301



PK-324



- Box size: 205x132x45mm(O.D.).

MODEL	CONTENTS	PK-301	PK-324
9K003A-1	Needle File Flat	•	
9K003B-1	Needle File Round	•	
9SD-201A	⊖ Pro-Soft Screwdriver (3x75mm)	•	
9SD-201B	⊕ Pro-Soft Screwdriver (#0x75mm)	•	
DK-2039	Utility Knife (3 Blades Self Loading)	•	
SI-168U	USB Powered Soldering Iron		•
9MS-020A	Rosin Oil		•
DP-366I	Mini Desoldering Pump		•
9DP-S002	Lead Free Solder Dispenser		•
9TZ-025T	Super Fine Tip Straight Tweezer	•	
PM-736	Long Nose Plier (132mm)	•	
PM-737	Diagonal Cutting Plier (109mm)	•	
9SB-395A	Dual Color TPR+PP Case	•	

TOOL KITS
TEST INSTRUMENTS
SOLDERING & DESOLDERING
FIBER OPTICS
CRIMPERS
PRECISION PLIERS & CUTTERS
ELECTRICAL PLIERS & CUTTER
STRIPPERS
PUNCH DOWN TOOLS
ALIGNMENT TOOL & SCREWDRIVERS
HEX KEY WRENCHES

Household Tool Kits

PK-2052TA/PK-2052TB

Technician's Tool Kit



PK-2052TA



PK-2052TB



- Case size: 415x330 x105mm(O.D.).

MODEL	CONTENTS	MODEL	CONTENTS
1PK-052	Lineman's Plier	CP-412G	Wire Strippers/Crimpers
1PK-067	Side Cutting Plier	DP-366D	Desoldering Pump
1PK-125T	Super Fine Tip Straight Tweezer	1PK-H028	Adjustable Wrench - 8"
1PK-709	Long Nose Plier	MT-1210	3 1/2 Digital Multimeter
9DK-2060	3M Measuring Tape	PD-2612	Curved Claw Hammer
9DP-S001	Pen Solder 63%	PD-513	Utility Knife
9FL-516	9PCS LED Flashlight	SD-5105A	⊖ Line Color Screwdriver (3x100mm)
9MS-001	PVC Insulated Tape	SD-5105B	⊕ Line Color Screwdriver (#0x100mm)
9PK-153	Brush	SD-5107A	⊖ Line Color Screwdriver (6x100mm)
9SD-329H	Screwdriver Probe Voltage Tester	SD-5107B	⊕ Line Color Screwdriver (#2x100mm)
9SD-9608	30PCS Aluminum Handle Precision Screwdriver set	SI-130B-20	Ceramic Soldering Iron (220V-240V or 110V-120V)
AS-611	Wrist Strap 10FT	SI-130A-20	
		9SB-2052	Plastic Tool Box

PK-2051T

General Household Tool Kit



- Case size: 320x260 x60mm(O.D.).

MODEL	CONTENTS	MODEL	CONTENTS
1PK-067	Side Cutting Plier	HW-221M	8PCS Aluminum Case Folding Hex Key(1.5,2,2.5,3,4,5,6,8mm)
1PK-709	Long Nose Plier	PD-513	Utility Knife
9DK-2060	3M Measuring Tape	SD-5101A	⊖ Line Color Screwdriver (3x75mm)
9FL-516	9PCS LED Flashlight	SD-5101B	⊕ Line Color Screwdriver (#0x75mm)
9MS-001	PVC Insulated Tape	SD-5107A	⊖ Line Color Screwdriver (6x100mm)
9SD-329H	Screwdriver Probe Voltage Tester	SD-5107B	⊕ Line Color Screwdriver (#2x100mm)
SD-9608	30PCS Aluminum Handle Precision Screwdriver set	SR-330	All Purpose Snip (165mm)
HW-008N	Adjustable Wrench - 8"	9SB-207	Plastic Tool Box

PK-618A/B

Universal Electrician Repair Tool Set



PK-618A



PK-618B



- Bag size: 228x340 x63.5mm(O.D.).

MODEL	CONTENTS	MODEL	CONTENTS
1PK-052DS	Lineman's Plier	9SD-200-M5	⊖ Pro-Soft Screwdriver 5mm (metric) or 3/16"(inch)
1PK-067DS	Side Cutting Plier	9SD-200-11	
1PK-125T	Super Fine Tip Straight Tweezer	9SD-201A	⊖ Pro-Soft Screwdriver (3x75mm)
1PK-709DS	Long Nose Plier	9SD-201B	⊕ Pro-Soft Screwdriver (#0x75mm)
1PK-H026	Adjustable Wrench - 6"	9SD-202A	⊖ Pro-Soft Screwdriver (5x75mm)
SI-130B-20	Ceramic Soldering Iron (220V-240V or 110V-120V)	9SD-207A	⊖ Pro-Soft Screwdriver (6x100mm)
SI-130A-20		9SD-207B	⊕ Pro-Soft Screwdriver (#2x100mm)
8PK-3161	Stripper (7 in 1)	HW-221M	Folding Type Hex Key Set (Metric or inch)
908-607	Alignment Tool	8PK-021NA	Contact Voltage Tester
9DP-031B	Desoldering wick	DK-2039	Utility Knife
9K003A-1	Needle File Flat	DK-2040	Measuring Tap
9K003B-1	Needle File Round	9ST-PK618	Tool Bag
9MS-001	PVC Insulated Tape		

TEST INSTRUMENTS



NETWORK TESTER 27

CLAMP METER 43

DIGITAL MULTIMETER 33

ENVIRONMENTAL METER 48

ANALOG MULTIMETER 41

Network Tester

MT-7076 LCD Network Cable Tester & Probe Kit



NEW



- Analog/Digital dual mode.
- Li-ion battery (Type-C).
- PoE switches & port flashing.
- Anti-interference.
- Crimp quality test.
- Cable length & mapping test.

ACCESSORIES

RJ45/RJ11/alligator clips cable x1set,
Type-C cable x1, Earphone x1,
Storage bag x1



TRANSMITTER SPECIFICATIONS

Display	LCD 53x29mm
Cable tracing signal	Analog / Digital
Cable tracing frequency	455kHz
Cable tracing range	1km(Analog) / 600m (Digital)
Cable map display	LCD: R&M 1-8/G
Cable length measurement	≤20m,±1.6m / 20m~100m, ±2.4m / 100m~200m, ±3.2m
Measurement unit	m/yd/ft
Port flash / Link test	Yes / Link test / 10M/100M/1000M; FDX/HDX; Auto-Nego/Non-Auto Nego.
Port flash /frequency	1time / 3 sec
PoE testing	Type : IEEE802.3af/at Non-Standard ; Midspan / Endspan/8pins ; Voltage values
Crimping test	Connector RJ45 8pin; ≥10cm
Back light	15 sec/30 sec/60 sec on/off
Auto off	15min /30min /60min/ off
Battery	3.7V 1400mAh Li-ion
Dimension	125x70x32 mm
Weight	172g

RECEIVER SPECIFICATIONS

Receiver signal	Analog / Digital
Vocality	Double
Response frequency	455kHz
Battery	3.7V 1400mAh Li-ion
Dimension	198x50x28 mm
Weight	147g

MT-7071N/MT-7071K LCD Cable Length Toner & Probe Kit



MT-7071N



NEW



MT-7071K



- Anti-interference.
- Cable length & mapping test.
- Port flashing & link test.

- Cable length measurement.
- Cable mapping (1 to 1 & 1 to 8).
- Performing cable map with multi remotes (ID#1~#8), it will indicate ID number of remote unit.

ACCESSORIES

- RJ45—RJ45 Cable x2
- RJ45- alligator clipsx1
- Earphonex1
- Storage bag x1

ACCESSORIES

- MT-7071 Remote unit x 8 (optional MT-7071U)
- RJ45—RJ45 patch cord x1
- RJ11—RJ11 patch cord x1
- RJ11—alligator clips patch cord x1
- Earbud x1
- Storage bag x1

MT-7071N TRANSMITTER SPECIFICATIONS

Display	LCD 128×64 Dots (50×27.5mm)
Cable tracing signal	Digital
Cable tracing frequency	455kHz
Cable tracing range	600m
Cable map display	LCD: R&M 1-8/G
Cable length measurement	2.5m—200m ±5%
Measurement unit	m/yd/ft
Port flash / Link test	10M/100M/1000M; FDX/HDX; Auto-Nego/Non-Auto Nego.Auto-Nego/Non-Auto Nego.
Port flash /frequency	1 time / 3 sec
Back light	5s/10s/15s/on/off
Auto off	15min/30min/1 hour/off
Working current	≤150mA
Protection	≤60V DC
Battery	9V: 6LR61 or 6F22 (Not included)
Dimension	138 X 80 X 35mm

MT-7071N RECEIVER SPECIFICATIONS

Response frequency	455kHz
Sound dB	≥85dB
Receiver signal	Elimination of noise
Tone mode	1 mode
Sensitivity	knob-operated control
Working current	≤100mA
Battery	9V: 6LR61 or 6F22 (Not included)
Dimension	202 × 50 × 32mm

MT-7071N REMOTE UNIT SPECIFICATIONS

Connectors	RJ45/BNC ports
Dimension	106x32x30mm

MT-7071K TRANSMITTER SPECIFICATIONS

Display	LCD 128×64 Dots (50×27.5mm)
Cable tracing signal	Analog
Tone mode	2 modes
Cable tracing frequency	580/1160 Hz
Cable map max distance	610m
Max distance of transmission	≥3km
Cable length measurement	2m—1200m ±5%
Measurement unit	m/yd/ft
Measurement rate	1 time / 3 sec
Calibrating parameters memory	7 sets (allow rewrite)
Auto off	15/30/60/120 min
Working current	≤65mA
Protection	≤48V DC
Battery	NEDA 1604/ 6F22 DC9V (not included)
Dimension	138 X 80 X 35mm

MT-7071K RECEIVER SPECIFICATIONS

Response frequency	580/1160 Hz
Receiver signal	Elimination of noise
Function selection	4 position mode switch (LED/NCV/OFF/SCAN)
Working current	≤80mA
Battery	NEDA 1604/ 6F22 DC9V (not included)
Dimension	202 × 50 × 32mm

MT-7071K REMOTE UNIT SPECIFICATIONS

Connectors	RJ45 / RJ11/12/ BNC ports
Dimension	106×32×30mm

MT-7029N**Noise-filtering Network
PoE Toner & Probe Kit****NEW**

- Anti-interference.
- Crimp quality test.
- Port flashing.

ACCESSORIES

RJ45 cable patch cord x1
 RJ11 cable patch cord x1
 RJ11 to alligator clips patch cord x1
 RJ45 to alligator clips patch cord x1
 Earphone x 1
 Storage bag x1

MT-7028**Network Toner & Probe Kit**

- Wire tracing 3km.

ACCESSORIES

RJ45 cable patch cord x 2
 RJ11 cable patch cord x 2
 RJ11 to alligator clips patch cord x1
 Earphone x1
 Storage bag x1

TRANSMITTER SPECIFICATIONS	MT-7029N	MT-7028
Cable tracing	Signal Voltage 8Vp-p	Signal Voltage 10Vp-p
	Signal frequency 455KHz	Signal frequency 1KHz
	Tracing distance 600m	Tracing distance 3km
Tone mode	One mode	Hi/Low two-note tone
Cable map test	8+1 LED indicators	8+1 LED indicators
	Test distance max: 300m	
Crimping test	Crimping socket for RJ45, crystal plug	-
	8 LED indicators	-
Port flash	1 LED indicators	-
Telephone line POL +/-	1 dual color LED: POL- (Green) / POL+ (Red)	
Auto power off	1 hour	-
Low battery indication	About 7.0V; Power LED flashing.	About 6.5V; Power LED flashing.
Voltage protection	DC 60V	DC 48V
Battery	9V (NEDA 1604/6F22) x1pcs (Not included)	
Dimension	138x80x35mm	
Weight	142g	140g
RECEIVER SPECIFICATIONS	MT-7029N	MT-7028
Response frequency	455KHz	1KHz
Tracing indication	1 LED indicator & speaker, anti-noise and sensitivity adjustable	1 LED indicator & buzzer, anti-noise and sensitivity adjustable
Cable map	8+1 LED indicators	
NCV	1 LED indicator & beeper (AC 90-1000V)	
Lighting	1 LED	
Low battery indication	About 7.0V	
Battery	9V (NEDA 1604/6F22) (Not included)	
Dimension	203x50x32mm	
Weight	95g	

MT-7059**LCD Multifunction Cable Tester****ACCESSORIES**

- Earphone x1
- RJ-45 cable x1
- RJ11 cable x1
- RJ11-alligator clips cable x1
- Storage bag x1

TRANSMITTER SPECIFICATIONS

Display	LCD 53X25mm, with back light
Cable tracing frequency	225kHz
Max. distance of transmission	2km
Max. distance of cable map	250m
Working current	≤70mA
Compatible connectors	RJ45(8 pin) / RJ11(6 pin) / BNC / USB / IEEE 1394
Max. signal voltage	1.5Vp-p
Function selection	3 Push button & 1 Power switch
Function and faults LCD	LCD display(Wiremap, Tone, Short, No adapter, UTP, STP, Low battery)
Cable map indication	LCD (#1~#8)
Shielded indication	LCD (#9)
Input protection	Voltage ≤DC 60V or AC 42V & Current ≤5mA
Battery	DC 9.0V(NEDA 1604/6F22 DC9V)×1pc (Not included)
Dimension	185 x 80 x 32mm
Weight	171g

RECEIVER SPECIFICATIONS

Frequency	225kHz
The Max. working current	≤70mA
Battery type	DC 9.0V(NEDA 1604/ 6F22 DC9V)×1pc (Not included)
Dimension (LxWxD)	218x46x29mm
Weight	91g

REMOTE UNIT SPECIFICATIONS

Compatible connectors	RJ-45(8 pin), RJ-11(6 pin), BNC, USB, IEEE 1394
Dimension (LxWxD)	107x30x24mm
Weight	42g

3PK-NT023N**Tone And Probe Kit****ACCESSORIES**

- Earphone x1
- Storage bag x1

TRANSMITTER SPECIFICATIONS

Tone frequency	1kHz
Max. testing distance	1.5km
Max. working current	≤20mA
Tone mode	One / Two-note tone
Connector port	RJ11(6 pin 2C), Alligator clips
Compatible connectors	De-energized AC wire, telephone / twisted pair wire, all voice or data category rated cable, virtually any cable or wire
Function selection	Tone / Off / Cont
Continuity test	1 LED(<500Ω), Coaxial cable & solid / stranded wire by alligator clips patch cord
Max. signal voltage	8V p-p
Voltage protection	DC 48V
Low battery indication	7V
Battery	DC 9.0V(NEDA 1604/6F22 DC 9V)×1pc, not included)
Dimension(L x W x H)	65x58x34mm
Weight	62g

AMPLIFIER PROBE

Frequency	1kHz
Max. working current	≤70mA
Function selection	4 Position mode switch(LED, NCV, OFF, SCAN)
Earphone socket	1
Signal status indication	1 LED & Buzzer
NCV indication	1 LED (AC 90~1000V)
Battery type	DC 9.0V(NEDA 1604/6F22 DC 9V)×1pc, not included)
Dimension(L x W x H)	230x56x25mm
Weight	80g

MT-7063 PoE & LAN Cable Tester**ACCESSORIES**

Storage bag x1

SPECIFICATIONS

Max. distance of cable map	300m	
Compatible connectors	RJ45(8 pin), RJ11/RJ12(6P6C/6P4C/6P2C), PoE	
Cable types tested	RJ45 Lan cable Cat. 5, 5e, 6, 7(UTP/STP), RJ11/12 Telephone Cable (6P/2C/4C/6C)	
Cable map indication	8 LEDs & 1 LED, Fast / Slow dual speed	
Shielded indication	LED(S)	
PoE indication(Master)	power supply mode	
	Mid-span	End-span
Dimension	123x66x35mm	
Battery type	DC 9.0V (not included)	
Weight	125g (Not included battery)	

MT-7058 Mini Lan Cable Tester**ACCESSORIES**BNC-RJ45 adaptor x1
Storage bag x1**SPECIFICATIONS**

Cables tested	UTP or STP LAN cables and RJ11/12 cables, Terminated in RJ45 connectors, BNC Coaxial Cables with male connectors	
Function	Cable mapping (1-8 LED), Shielded indicator (S)	
	Automatic & Step by step scan model.	
	Straight cable indicator(Straight)	Short Indicator (Short)
	Crossover indicator (Crossover)	No connection indicator (No connection)
	Buzzer tone & LED indicator	Low battery indicator (Power)
	Non-connector voltage detector (NCV) AC 60V~240V (50/60Hz)	
Testing distance	300m (Max)	
Battery	9V (6F22) x 1pce (Not included)	
Dimension	140 x 70 x 35mm	
Weight	128g	

MT-7064 PoE & LAN Cable Tester**ACCESSORIES**

Storage bag x1

SPECIFICATIONS

Max. distance of cable map	300m			
Compatible connectors	RJ45(8 pin), RJ11/RJ12(6P6C/6P4C/6P2C), PoE			
Cable types tested	RJ45 Lan cable Cat. 5, 5e, 6, 7(UTP/STP), RJ11/12 Telephone Cable (6P/2C/4C/6C)			
Cable map indication	8 LEDs & 1 LED, Fast/Slow dual speed			
Shielded indication	LED(S)			
PoE indication(Master)	Power supply mode		PoE standard	
	Mid-span	End-span	802.3af	802.3at
Dimension	123x66x35mm			
Battery type	DC 9.0V (not included)			
Weight	125g (Not included battery)			

MT-7031 Mini Lan Cable tester**ACCESSORIES**

BNC-RJ45 adaptor x1

SPECIFICATIONS

Cables Tested	UTP or STP LAN cables and RJ11/12 cables, Terminated in RJ45 connectors, BNC Coaxial Cables with male connectors
Display	1-8 LED , S (Shielded)
Max. Testing Distance	300m
Battery	12V 23A (Not included)
Dimension	112x60x25mm
Weight	76g

MT-7051N Mini Lan Cable Tester



ACCESSORIES

BNC connector x1
Storage bag x1

SPECIFICATIONS

Compatible connectors	RJ45 (8 pin), RJ11 (6 pin), BNC
Cable types tested	UTP, STP, Cat. 5e, Cat. 6, Cat. 7 telephone cable, RG6, RG58, RG59, CATV/CCTV coaxial cable
Test mode	3 modes
Cable mapping	8 LEDs
Shielded indication	Yes
Battery	NEDA 1604/ 6F22 DC9V *1pce(Not included)
Dimension	105 x 65 x 28mm

REMOTE UNIT SPECIFICATIONS

Compatible connectors	RJ45 (8 pin), RJ11 (6 pin), BNC
Dimension	105 x 38 x 28mm
Weight (Total)	122g

MT-7057N Cable Sniffer-Remote



ACCESSORIES

RJ45 to female BNC
Storage bag x1

SPECIFICATIONS

Functions	Test on RJ45 EIA/TIA-568A/B, AT&T258A, RJ11/12 USOC4/6/8, EtherneT 10 Base-T, Token Ring, Telephone, USB, BNC coaxial cable, Phone Net and cabling system.
	Low battery indication
	Beeper warning
Test distance	500M(1,640ft)
Battery	9V (NEDA 1604/ 6F22) (not included)
Dimension	160 x 85 x 25mm
Weight (Total)	156g

MT-8004 Telephone Line Tester



NEW



ACCESSORIES

Belt

- Function: recall, callback, flash break.
- Overload protection.
- Date setting.
- Time setting.
- Call record.
- Call duration check.
- Delete memory.
- Dialing number.

SPECIFICATIONS

Display	LCD, 41x15mm
LCD brightness level	5
Extension port	RJ11, Alligator clip
DC resistance	≤350Ω
Dialing output	Tone / Pulse
Memory dialing	16 memories(8digits) / 12 memories(12digits) 10 memories(16digits) / 5 memories(32digits)
Caller ID	62 memories(8digits) 43 memories(12digits) / P38 memories(16digits)
Incoming call indicator	Flashing green light
Incoming call vol.	≥70dBA
Incoming call display	Automatically identifying DTMF or FSK system, 16 digits
Dimension	160 x 67 x 32 mm
Weight	224g

Digital Multimeter

MT-1820N 3 5/6 Dual Display DMMw/USB Connector



ACCESSORIES

- Temperature probe x1
- Multi-function socket x1
- Test leads x1
- USB Cable (Type-C) x1
- CD software x1

- USB connector for PC.
- Auto/Manual range.
- Dual display with analog bar graph.
- Diode test, continuity with beeper, NCV, live line detecting, duty cycle, relative reference, Max/Min, data hold, back light, auto power off, low battery indication.

CAT IV 600V
CAT III 1000V

NEW

SPECIFICATIONS

DCV	600mV/6V/60V/600V±(0.5%+4d); 1000V±(1.0%+6d)
ACV	6V/60V/600V±(0.8%+10d); 750V±(1.0%+10d); 40~1kHz True RMS
DCA	600µA/6000µA/60mA/600mA±(1.0%+10d); 6A/10A±(1.2%+10d)
ACA	600µA/6000µA/60mA/600mA±(1.5%+10d); 6A/10A±(2.0%+15d); 40~1kHz True RMS
Resistance	600Ω±(0.8%+5d); 6KΩ/60KΩ/600KΩ/6MΩ±(0.8%+4d); 60MΩ±(1.2%+10d)
Capacitance	60nF±(5.0%+30d); 600nF/6µF/60µF±(3.5%+8d); 600µF/6mF/60mF±(5.0%+10d); 99.9mF (reference)
Frequency	10/100/1K/10K/100K/1M/30M Hz±(0.5%+4d)
Temperature	-20°C~1000°C: <400°C±(1.0%+5d), ≥400°C±(1.5%+15d) -4°F~1832°F: <752°F±(1.0%+5d), ≥752°F±(1.5%+15d)
Battery	1.5V AAAx4 (not included)
Dimension	189x88x56mm
Weight	380g (batteries not included)

MT-1710N 3 3/4 True-RMS Auto Range Multimeter



ACCESSORIES

- Test lead
- Temperature probe
- hFE test adapter

- True RMS measurement.
- 100mF capacitor test.
- NCV + Live wire test.

CAT IV 600V

NEW

SPECIFICATIONS

DCV	40/400mV±(0.5%+5d); 4/40/400V±(0.5%+4d); 1000V ±(1.0%+6d)		
ACV	40/400mV±(1.0%+6d); 4/40/400V±(0.8%+10d); 750V±(1.2%+10d) TRUE-RMS 40~1KHz		
DCA	400µA/4000µA ±(1.0%+10d); 40/400mA ±(1.2%+8d); 4/10A ±(1.2%+10d)		
ACA	400µA/4000µA/40mA/400mA±(1.5%+10d); 4/10A ±(2.0%+5d) TRUE-RMS 40~1KHz		
Resistance	400Ω±(0.8%+5d); 4KΩ/40KΩ/400KΩ/4MΩ±(0.8%+4d); 40MΩ±(1.2%+10d)		
Frequency (Hz)	10/100/1K/10K/100K/1M/20MHz±(0.5%+10d)		
Capacitance	6nF ±(0.5%+40d); 60n/600n/6µ/60µ/600µF±(3.5%+20d); 6mF±(5.0%+10d); 60/100mF±10%		
Temperature (°C/°F)	-20°C~1000°C: <400°C±(1.0%+5d), ≥400°C±(1.5%+15d) -4°F~1832°F: <752°F±(1.0%+5d), ≥752°F±(1.5%+15d)		
Diode	Y	Continuity	Buzzer sounds ≤50±20Ω
hFE	0 ~ 1000(NPN or PNP)		
Battery	4x 1.5V AAA (Not included)		
Dimension	186×92×52mm		
Weight	355g		

MT-1708 3 5/6 Smart Digital Multimeter



- One touch measurement.
- hFE test.
- Live wire test.
- NCV detection.
- LED light.
- LCD backlight.
- Data hold. Analog scale bar.
- Low battery indication.

SPECIFICATIONS

Display	3 5/6 5999 Counts
DCV	6V/60V/600V±(0.8%+3d)
ACV	6V/60V/600V±(1.2%+3d), TRUE-RMS(45-65Hz)
DCA	600mA±(1.0%+3d)
ACA	600mA±(1.5%+3d), TRUE-RMS(45-65Hz)
Frequency	30~1000Hz±(0.5%+2d)
Temperature	-20~1300°C±(1.0%+3d), -4°F~2372°F±(0.5%+ 2d)
Resistance	6kΩ/60kΩ/600kΩ±(1.0%+3d), 6MΩ/10MΩ±(1.2%+5d)
Capacitance	60nF/600nF/6μF/60μF/600μF/6mF±(4%+5d)
Continuity Buzzer	≤30Ω
hFE	0 ~ 1000(NPN or PNP)
Battery	1.5V AAA x 3 (Not included)
Dimension	169 x 83 x 53mm
Weight	322g

ACCESSORIES

Fuse x 2, Test lead,
Temperature probe

MT-1280D 3 5/6 Digital TRUE RMS Multimeter



- Auto backlight.
- Fuse burnt alarm.
- True RMS measurement.
- Diode test.
- hFE test.
- Continuity buzzer.
- NCV detection.
- Live wire test.
- Data hold.
- Lower battery indication
- Flashlight.

CAT IV 600V

NEW

SPECIFICATIONS

DCV	600mV/6V/60V/600V/1000V±(0.5%+3d)
ACV (TRUE-RMS)	6V/60V±(0.8%+3d); 600V/750V(1.0%+3d) Frequency response: 40Hz~1kHz
DCA	6mA/60mA/600mA±(0.8%+3d); 20A±(1.5%+10d)
ACA (TRUE-RMS)	60mA/600mA±(1.0%+3d); 20A±(2.0%+10d) Frequency response: 40Hz~1kHz
Resistance	600Ω/6KΩ/60KΩ/600KΩ±(0.8%+3d); 60MΩ±(1.2%+30d)
Capacitance	1nF, 60mF±(5.0%+30d) 10nF/100nF/1μF/10μF/100μF/1mF±(2.5%+10d)
Frequency	10Hz/100Hz/1kHz/10kHz/100kHz/1MHz/ 10MHz±(1.0%+3d)
Temperature	-20°C~1000°C: <400°C±(1.0%+5d), ≥400°C±(1.5%+15d) -4°F~1832°F: <752°F±(1.0%+5d), ≥752°F±(1.5%+15d)
Battery	9V 6F22 x 1pce (not included)
Dimension	192 x 89 x 55 mm
Weight	320g (without battery)

ACCESSORIES

Test leads
Temperature probe

MT-1217**3 5/6 True RMS Digital Multimeter****CAT III 1000V**

- Auto range.
- Auto power off.
- Data Hold.
- Diode/triode test.
- Continuity with beeper.
- Low battery indication.
- Transistor test.
- LED indicator.

ACCESSORIES

Test leads
Temperature probe
Test socket

DCV	600mV/6V/60V/600V±(0.5%+4d), 1000V±(1.0%+6d)
ACV	600mV±(1.0%+10d), 6V/60V/600V±(0.8%+6d), 750V±(1.0%+10d), Frequency response:(40~1000)Hz True RMS
DCA	600µA/6000µA/60mA/600mA±(1.0%+10d), 10A±(1.2%+10d)
ACA	600µA/6000µA/60mA/600mA±(1.5%+10d), 10A±(2.5%+15d), Frequency response:(40~1000)Hz True RMS
Resistance	600Ω±(0.8%+5d), 6kΩ/60kΩ/600kΩ/6MΩ±(0.8%+4d), 60MΩ±(1.2%+10d)
Frequency	9.999Hz~20MHz±(1%+10d)
Duty cycle	0.1-99%
Capacitance	9.999nF±(5%+35d), 9.999nF~999.9µF±(3.5%+8d), 999.9µF~6mF±(3.5%+35d)
Temperature	-20°C~1000°C: <400°C±(1.0%+5d), ≥400°C±(1.5%+15d) -4°F~1832°F: <752°F±(1.0%+5d), ≥752°F±(1.5%+15d)
Battery	9V 6F22 x1 (Not included)
Dimension	182×90×46mm
Weight	318g

MT-1280**3 5/6 Digital True RMS Multimeter****CAT III 1000V**

- Auto power off.
- Data hold.
- Transistor test.
- Diode test.
- Continuity with beeper.
- Low battery indication.
- LED indicator.
- LED backlight.
- NCV detection.
- LCD backlight.

ACCESSORIES

Test leads
Transistor test socket
Temperature probe

DCV	600mV/6V/60V/600V±(0.5%+3d), 1000V±(0.8%+10d)
ACV	6V/60V/600V±(0.8%+5d), 750V±(1.2%+10d), Frequency response:(40~1000)Hz True RMS
DCA	600µA/6mA/60mA±(0.8%+10d), 600mA±(1.2%+8d), 20.00A±(2%+5d)
ACA	60mA±(1%+5d), 600mA±(2%+5d), 20.00A±(3%+10d), Frequency response:(40~1000)Hz True RMS
Resistance	600Ω±(0.8%+5d), 6kΩ/60kΩ/600kΩ±(0.8%+3d), 60MΩ±(1%+25d), 600MΩ±(5%+10d)
Frequency	45~1000Hz±(1.0%+5d)
Capacitance	9.999nF ±(5%+35d), 9.999nF~999.9µF±(2.5%+20d), 999.9µF~2000µF ±(5%+35d)
Temperature	-20°C~1000°C: <400°C±(1.0%+5d), ≥400°C±(1.5%+15d) -4°F~1832°F: <752°F±(1.0%+5d), ≥752°F±(1.5%+15d)
Battery	9V(6F22)x1 (Not Included)
Dimension	182 × 90 × 46mm
Weight	318g

MT-1707**3 5/6 True RMS Multimeter****CAT III 1000V
CAT IV 600V**

- Input alert protection.
- Data hold.
- Continuity test.
- Diode test.
- Duty cycle.
- Auto power off.
- Low battery indication.
- NCV detection.
- LED indicator.

ACCESSORIES

Test leads
Temperature probe

DCV	600mV/6V/60V/600V/1000V±(0.5%+3d)
ACV	6V/60V±(0.8%+3d), 600V/750V±(1%+10d) Frequency Response:40Hz-1KHz True RMS
DCA	600µA/60mA/600mA±(0.8%+3d), 10.00A±(1.5%+10d)
ACA	60mA/600mA±(1%+3d), 10.00A±(2%+10d) Frequency Response:40Hz-1KHz True RMS
Resistance	600Ω/6kΩ/60kΩ/600kΩ±(0.8%+3d), 60MΩ/600MΩ±(1.2%+30d)
Frequency	9.999Hz/99.999Hz/999.9Hz/9.999KHz/ 99.99KHz/999.9KHz/9.99MHz±(1.0%+3d)
Capacitance	1nF±(4.0%+30d), 10nF/100nF/1µF/10µF/100µF/1mF±(2.5%+10d) 60mF±(5.0%+30d)
Temperature	-20°C~1000°C/-4°F~1832°F±(1.0%+3d)
Fuse	F500mA/250V F10A/250V
Battery	6F22 9V x1 (Not included)
Dimension	190 × 89 × 53mm
Weight	315g (Without battery)

MT-1270**3 1/2 Digital Multimeter****CAT III 1000V**

- Auto power off.
- Data hold.
- Diode test.
- Temperature test.
- Low battery indication.
- Transistor test.
- LCD backlight.

ACCESSORIES

Test lead(optional: MT-9906)
Transistor test socket
Temperature probe

DCV	200mV/2V/20V/200V±(0.5%+3d) 1000V±(0.8%+10d)
ACV	2V/20V/200V±(0.8%+5d), 750V±(1.2%+10d)
DCA	2mA/20mA±(0.8%+10d), 200mA±(1.2%+8d), 10A±(2.0%+5d)
ACA	20mA ±(1.0%+15d), 200mA ±(2.0%+5d), 10A ±(3.0%+10d)
Resistance	200Ω±(0.8%+5d), 2KΩ/20KΩ/200KΩ/2MΩ±(0.8%+3d) 20MΩ±(1.0%+25d), 200MΩ±(5%+30d)
Frequency	20K Hz±(3.0%+18d)
Capacitance	2nF/20nF/200nF/2µF±(2.5%+20d), 20µF±(5.0%+10d)
Temperature	-20°C~400°C±(1.0%+5d), 400°C~1000°C±(1.5%+15d)
Battery	9V(6F22)x1 (Not Included)
Dimension	182 × 90 × 46 mm
Weight	320g

MT-1220 3 1/2 Digital Multimeter



CAT II 600V

- Lead free.
- Data hold.
- Diode test.
- Continuity with beeper.
- Low battery indication.
- NCV detection.
- LED indicator.
- LED backlight.
- LED light.
- Transistor test.

ACCESSORIES

Test leads



DCV	200mV/2V/20V/200V±(0.5%+5d), 600V±(0.8%+5d)
ACV	200V±(1.0%+10d)/600V±(1.2%+10d)
DCA	2mA/20mA/200mA±(1.0%+5d), 10A±(3.0%+10d)
Resistance	200Ω/2KΩ/200kΩ/2MΩ±(1%+3d), 20MΩ±(1.5%+3d)
Battery	1.5V AAA x 3pcs (not included)
Dimension	148 x 79 x 48mm
Weight	210g (without battery)

MT-1225 3 1/2 Digital Multimeter



CAT II 600V

- Lead free.
- Data hold.
- Diode test.
- Continuity with beeper.
- Low battery indication.
- NCV detection.
- LED backlight.
- LED light.
- LED indicator.
- Transistor test.

ACCESSORIES

Test leads

Temperature probe



DCV	200mV/2V/20V/200V±(0.5%+5d), 600V±(0.8%+5d)
ACV	200V±(1.0%+10d)/600V±(1.2%+10d)
DCA	20mA/200mA±(1.0%+5d), 10A±(3.0%+10d)
Resistance	200Ω/2KΩ/200kΩ/2MΩ±(1%+3d), 20MΩ±(1.5%+3d)
Temperature Test	-20°C~1000°C±(1%+3d)
Battery	1.5V AAA x 3pcs (not included)
Dimension	148 x 79 x 48mm
Weight	210g (without battery)

MT-1236 3 5/6 True RMS Digital Multimeter



CAT II 600V

- Auto range.
- Lead free.
- Diode test.
- Continuity with beeper.
- Data hold.
- Duty cycle.
- Auto power off.
- Low battery indication.
- NCV detection.
- LED backlight.
- LED light.
- LED indicator.

ACCESSORIES

Test leads

Temperature probe



DCV	600mV/6V/60V/600V±(0.5%+5d)
ACV	600mV/6V/60V/600V±(1%+4d) TRUE-RMS
DCA	60mA/600mA±(1.2%+5d), 10A±(3.0%+5d)
ACA	60mA/600mA±(1.5%+5d), 10A±(3.0%+5d) TRUE-RMS
Frequency	9.999Hz/99.99Hz/999.9Hz/9.999KHz/99.99KHz/999.9KHz/9.999MHz±(1.5%+5d)
Duty Cycle	1%~99%±(2.5%+5d)
Resistance	600Ω/6KΩ/60kΩ/600kΩ/6MΩ/60MΩ±(0.8%+5d)
Capacitance	60nF/600nF/6μF/60μF/600μF/6mF±(4%+5d), 100mF±(4%+10d)
Temperature	-20°C~1000°C±(1%+3d), -4°F~2372°F±(1%+3d)
Continuity Buzzer	≤30Ω, buzzer beeps
Battery	1.5V AAA x 3pcs (not included)
Dimension	148 x 79 x 48mm
Weight	210g (without battery)

MT-1232 3 3/4 Auto-Range Digital Multimeter



CAT III 600V

- Lead free.
- Data hold.
- Diode test.
- Continuity with beeper.
- Low battery indication.
- Auto power off.
- Backlight.
- Relative value measurement.

ACCESSORIES

Test leads

Temperature probe



DCV	400mV/4V/40V/400V±(0.5%+4d), 600V±(1.0%+4d)
ACV	4V/40V/400V±(0.8%+6d), 600V±(1.0%+6d)
DCA	400μA/4000μA/40mA/400mA±(1.0%+10d), 10A±(1.2%+10d)
ACA	400μA/4000μA/40mA/400mA±(1.5%+10d), 10A±(2.5%+15d)
Resistance	400Ω±(0.8%+5d), 4kΩ/40kΩ/400kΩ/4MΩ±(0.8%+4d), 40MΩ±(1.2%+10d)
Frequency	1/10/100/1K/10K/100K/1M/10MHz±(0.5%+10d)
Capacitance	4nF±(5.0%+9d), 40nF/400nF/4μF/40μF±(3.5%+8d), 100μF±(5.0%+8d)
Temperature	-20°C~1000°C: <400°C±(1.0%+5d), ≥400°C±(1.5%+15d)
Battery	1.5V AA x 2 (not included)
Size	147 x 78 x 41 mm
Weight	188g

MT-1226**3 1/2 Digital Multimeter****NEW**

- Diode test.
- Continuity with beeper.
- Low battery indication.
- Auto power off.
- 30-Gears fully functional.
- 4 test lead sockets.
- True-RMS.

ACCESSORIES

Test leads

SPECIFICATIONS

DCV	200mV/2V/20V/200V±(0.5%+4d); 1000V±(0.8%+15d)
ACV	2V/20V/200V±(0.8%+4d); 750V±(1.0%+15d); 40~1000Hz True RMS
DCA	200µA/2mA/20mA/200mA±(0.8%+5d); 10A±(1.5%+15d)
ACA	200mA±(2.0%+15d); 10A±(3.5%+15d); 40~1000Hz True RMS
Resistance	200Ω/2kΩ/20kΩ/200kΩ/2MΩ/20MΩ±(1.0%+25d); 200MΩ±(5.0%+30d)
Capacitance	20nF/2µF(2.5%+20d); 200µF(5.0%+10d)
Battery	9V 6F22/ NEDA 1604 x 1 (not included)
Dimension	167x81x43mm
Weight	162g (no battery include)

MT-1210**3 1/2 Compact Digital Multimeter****CAT II 600V**

- Diode test.
- Continuity with beeper.
- Low battery indication.
- Backlight.
- Data hold.
- Transistor test.
- 1.5V battery test.

ACCESSORIES

Test leads

SPECIFICATIONS

DCV	200mV/2V/20V/200V±(1.0%+2d); 500V±(1.2%+5d)
ACV	200/500V±(2.5%+10d)
DCA	200µ/2mA/20mA/200mA±(2.0%+5d); 10A±(3.0%+5d)
Resistance	200Ω/2KΩ/20KΩ/200KΩ±(1.0%+5d); 2MΩ±(1.5%+5d)
Battery	9V(6F22)×1 (not included)
Dimension	147 × 74 × 35mm
Weight	180g

MT-1233C/ MT-1233D**3 1/2 Digital Multimeter****MT-1233C****MT-1233D**

- LCD backlight.
- Data hold.
- °C and °F temperature test (MT-1233C).
- Square signal output (MT-1233D).

MT-1233C ACCESSORIES

Test leads
Temperature probe

MT-1233D ACCESSORIES

Test leads

**CAT II 300V**

MODEL	MT-1233C	MT-1233D
DCV	200m/2000m/20/200V±(0.8%+3d); 500V±(1.0%+3d)	
ACV	200/500V±(1.2%+5d)	
DCA	2000µ/20m/200mA±(1.2%+5d); 10A±(2.5%+5d)	
Resistance	200Ω±(1.5%+5d), 2000Ω/20k/200kΩ±(1.0%+3d), 20MΩ±(1.0%+5d)	200Ω±(1.5%+5d), 2000Ω/20kΩ/200kΩ±(1.0%+3d), 20MΩ±(1.0%+5d), 200MΩ±(1.0%+10d)
Temperature	-40~150°C±(1.0%+3d), 150~1000°C±(1.5%+15d), -40~302°F(1.0%+4d), 302~1832°F±(1.5%+15d)	-
Square signal output	-	50Hz (3Vp-p, 50KΩ)
Battery	1.5V AAA x 2 (not included)	
Size	130 x 72 x 28mm	



- Auto ranging.
- Card type large screen.
- True RMS measurement.
- Dual value display screen.
- Non-contact electrometry.

ACCESSORIES

Test leads
Temperature probe

SPECIFICATIONS

DCV	6V/60V/600V±(0.8%+5d)
ACV	6V/60V/600V±(1.0%+5d) True RMS
DCA	1000mA/10A±(2.0%+5d)
ACA	1000mA/10A±(2.0%+5d) True RMS
Resistance	600Ω/6KΩ/60KΩ/600KΩ/6MΩ/60MΩ±(1.0%+5d)
Capacitance	6nF/60nF/600nF/6μF/60μF/600μF/6mF/100mF±(4.0%+5d)
Temperature	-20°C~530°C±(3%+5d) -4°F~986°F±(3%+5d)
Frequency	1000Hz/6KHz±(2.0%+5d)
Battery	1.5V AAA x 2 (Not included)
Dimension	150 x 75 x 19mm
Weight	175g



LED Flashlight



TPU Protective Case

Shockproof • Anti-slip • Soft Grip



MT-5211 3 1/2 Digital LCR Multimeter



CAT IV 600V

- Ineuctance test.
- Transistor test.
- Diode test.
- Continuity with beeper.
- Auto power off.
- Low battery indication.
- Backlight.
- Data hold.
- Transistor test.
- Overload indication.

ACCESSORIES

Temperature probe
Test leads
Test socket



SPECIFICATIONS

DCV	200mV/2V/20V/200V±(0.5%+3d), 1000V±(1.0%+5d)
ACV	200mV±(1.2%+3d), 2V/20V/200V±(0.8%+5d), 750V±(1.2%+5d)
DCA	2mA/20mA±(0.8% +3d), 200mA±(1.2% +4d), 20A±(2.0% +5d)
ACA	2mA/20mA±(1.0%+5d), 200mA±(2.0%+5d), 20A ±(3.0% +10d)
Resistance	200Ω±(0.8%+5d), 2KΩ/20KΩ/200KΩ/2MΩ±(0.8%+3d), 20MΩ±(1.0%+15d), 2000MΩ±(5.0%(reading-10) +20d)
Capacitance	20nF/200nF/2μF±(2.5%+20d), 20μF/200μF±(5.0%+5d)
Inductance	2mH/20mH/200mH/2H/20H±(2.5%+20d)
Temperature	-20~400°C±(1.0%+4d), ≥400°C~1000°C±(1.5%+15d)
Frequency	2k/20k/200k/2000K/10M Hz±(1.0%+10d)
Battery	9V 6F22 (not included)
Size	189×97.5×35mm
Weight	390g

MT-5110 3 1/2 Capacitance Meter



- Low battery indication.
- Backlight.
- Overload indication.

ACCESSORIES

Test lead
Alligator clips
Test socket



SPECIFICATIONS

Capacitance	200pF±(0.5%+7d), 2n/20n/200n/2μ/20μ/200μF±(0.5%+5d), 2,000μF±(2.0%+5d), 20000μF±(3.0%+10d)
Zero adjustment	Manual (range:±20pF)
Over-input	Display shows "1"
Sampling time	0~5 second
Battery	NEDA1604/6F22 (9V) x 1pce (not included)
Dimension	182x90x46mm
Weight	315g

MT-1509**Pocket Auto-Range Multimeter****CAT III 600V**

- Auto Selection and Auto Range.
- One touch.
- Continuity test.
- Auto power off.
- Low battery indication.
- Backlight.
- Data hold.
- Overload indication.
- NCV detection.
- Non-contact ACV detector.
- LED flashlight.

SPECIFICATIONS

DCV	2V/20V/200V±(0.5%+3d), 600V±(0.8%+5d)
ACV	2V/20V/200V±(0.8%+3d), 600V±(1.0%+5d)
Resistance	2k/20k/200k/2MΩ±(1.0%+3d), 10MΩ±(1.2%+15d)
Battery	2 x 1.5V AAA (not included)
Dimension	125 x 60 x 26 mm
Weight	140g (Not included battery)

MT-1508**Pocket Auto-Range Multimeter****CAT III 600V**

- Diode test.
- Continuity test.
- Auto power off.
- Low battery indication.
- Backlight.
- Data hold.
- Overload indication.
- NCV detection.
- LED light.

SPECIFICATIONS

DCV	200mV/2V/20V/200V±(0.5%+3d), 600V±(0.8%+5d)
ACV	2V/20V/200V±(0.8%+3d), 600V±(1.0%+5d)
DCA	200μA/2000μA/20mA/200mA±(1.8%+5d)
ACA	200μA/2000μA/20mA/200mA±(2.0%+5d)
Resistance	200/2k/20k/200k/2MΩ±(1.0%+3d), 20MΩ±(1.2%+15d)
Battery	2 x 1.5V AAA (not included)
Dimension	125x60x26 mm
Weight	152g (not included battery)

MT-1506**Pocket True-RMS Auto-Range Multimeter****CAT II 600V**

- Diode test.
- Continuity test.
- Duty cycle.
- Auto power off.
- Low battery indication.
- Relative reference.

SPECIFICATIONS

DCV	400mV, 4/40/400V±(0.5%+4d), 600V±(1%+4d)
ACV	400mV±(1.5%+6d), 4/40/400V±(0.8%+6d), 600V±(1.0%+6d) True-RMS
Resistance	400Ω ±(0.8%+5d), 4kΩ/40kΩ/400kΩ/4MΩ±(0.8%+4d), 40MΩ±(1.2%+5d)
Frequency	100Hz/1000Hz/10kHz/100kHz/1MHz/10MHz ±(0.5%+4d)
Capacitance	4nF±(5%+40d), 40n/400n/4μ/40μ±(3.5%+8d), 2000μF±(5%+8d)
Battery	1.5V AAA x 2 (not included)
Dimension	124 x 80 x 20 mm
Weight	116g

MT-1630**3 1/2 Pen-Style Meter**

- Lead free.
- Diode test.
- Continuity test.
- Auto power off.
- Low battery indication.
- Pen light.
- Data hold.
- Overload indication.
- Fuse protection.

SPECIFICATIONS

DCV	200mV/2V/20V/200V/600V±(0.8%+5d)
ACV	2V/20V/200V±(1%+3d), 600V±(1.2%+3d)
DCA	20mA/200mA±(1.5%+10d)
ACA	20mA/200mA±(3.0%+10d)
Resistance	200Ω±(1.0%+5d), 2kΩ/20kΩ/200kΩ/2MΩ±(1.0%+3d), 20MΩ±(1.2%+5d)
Battery	LR44 (1.5V) x 2 (not included)
Dimension	205x35x30mm
Weight	96g (not include battery)

* For packing info please refer to the index at the back.

Analog Multimeter



MT-2017N Protective Function Analog Multimeter



- LED & hFE test.
- Capacitance measurement.
- Overload protection.
- Gilded test lead.
- Resettable fuses.

ACCESSORIES

Test lead

SPECIFICATIONS	
DCV	0.1/2.5/10/50/250V±3.0%FSD,1000V±4.0%FSD
Null DCV	DC±5V,±25V±5.0%FSD
ACV	10/50/250V±4.0%FSD,1000V±5.0%FSD
DCA	50μA/2.5mA/25mA±3.0%FSD,10A ±4.0%FSD
Resistance	×1(0.2~2kΩ)/×10(2~20kΩ)/×100(20~200kΩ)/ ×1k(200~2MΩ)/×10k(2k~20MΩ)±4.0%ARC of scale length
Capacitance	C(R×1k):2000μF(Approx.) Max
Battery check	1.5V/9V
Front panel controls	Range selector switch with "OFF" position, 0Ω adjust knob
Battery	1.5V AAA x 2 and 9V(NEDA1604) x 1 (not included)
Dimension	171 x 108 x 37mm
Weight	315g

MT-2019 Protective Multifunction Analog Multimeter



- LED & hFE test.
- Capacitance measurement.
- Overload protection.

ACCESSORIES

Test leads

SPECIFICATIONS	
DCV	0.1/2.5/10/50/250V±3.0%FSD,1000V±4.0%FSD
ACV	10/50/250V±4.0%FSD,1000V±5.0%FSD
DCA	0.05/2.5/25/250mA ±3.0%FSD
Resistance	×1(0.2~2kΩ)/ ×10(2~20kΩ)/×100(20~200kΩ)/ ×1k(200~2MΩ)/×10k(2k~20MΩ)±4.0%ARC of scale length
Capacitance	C(RX1K):2000μF(Approx.)Max
Battery check	1.5 / 9V
hFE	hFE: 0-1000
Battery	1.5V AAA x2 & 9V(NEDA1604) x1 (not included)
Dimension	160x105x40mm
Weight	300g

MT-2207 Protective Function Analog Multimeter



NEW

**CAT II 1000V
CAT III 500V**

- hFE test.
- Diode test.
- Continuity test.
- LED test.
- 1000V/10A test.



ACCESSORIES

Test lead

SPECIFICATIONS

DCV	0.25V-1V-2.5V-10V-50V-250V-500V±3%FSD; 1000V(2500V)±4%FSD
ACV	10V-50V-250V-500V±4%FSD;1000V(2500V)±5%FSD
DCA	50µA-0.5mA-5mA-50mA-500mA ±3%FSD; 10A±4%FSD
Resistance	X1(0.2~2KΩ)/X10(2~20KΩ)/X100(20~200KΩ)/ X1K(200~2MΩ)/X10K(2K~20MΩ)±4.0% ARC of scale length
Capacitance	Cx1/Cx10/Cx100/Cx1k/Cx10k:Approx. Value
Continuity with beeper	<50Ω
Battery check	1.2V-3.6V
Decibel (dB)	Yes
FUSE	F0.5A 250V;F10A 250V,φ5x20mm
Battery	1.5V AAA x2 (not included)
Dimension	179x118x50mm
Weight	400g

MT-2208 Protective Function Analog Multimeter



NEW

**CAT II 1000V
CAT III 500V**

- hFE test.
- Diode test.
- Continuity test.
- Infrared signal detection.
- LED test.
- 1000V/10A test.



ACCESSORIES

Test lead

SPECIFICATIONS

DCV	0.25V-1V-2.5V-10V-50V-250V±3%FSD; 1000V(2500V)±4%FSD
ACV	10V-50V-250V±4%FSD;1000V(2500V)±5%FSD
DCA	50µA-0.5mA-5mA-50mA-500mA±3%FSD; 10A±4%FSD
Resistance	X1(0.2~2KΩ)/X10(2~20KΩ)/X100(20~200KΩ)/ X1K(200~2MΩ)/X10K(2K~20MΩ)/X100K(20K~200MΩ)± 4.0% ARC of scale length
Capacitance	Cx1/Cx10/Cx100/Cx1k/Cx10k:Approx. Value
Continuity with beeper	<50Ω
Battery check	1.2V-3.6V
Decibel (dB)	Yes
FUSE	F0.5A 250V;F10A 250V,φ5x20mm
Battery	1.5V AAA x2 (not included)
Dimension	179x118x50mm
Weight	500g

MT-9905/MT-9906/MT-9907 Test Lead



MT-9905



MT-9906



MT-9907



MODEL	Probe	Hand piece	Lead length	Plug	OAL.(mm)	Weight
MT-9905	∅2x17mm	125mm	1000mm	∅4.2x15mm	1200mm	75g
MT-9906		146mm	900mm		1120mm	78.5g
MT-9907		129mm			1100mm	74g

* For packing info please refer to the index at the back.

Clamp Meter

MT-3209 3-5/6 AC/DC Digital Clamp Multimeter



- ACV ACA true RMS measurement.
- VFC detection.
- Loz measurement.
- NCV detection.
- Diode test.
- Continuity test.
- Data hold.
- Auto power off.
- Low battery indication.
- Back light.
- LED light.

ACCESSORIES

Temperature probe
Test lead
Storage bag

SPECIFICATIONS	
Max. jaw opening	30mm
DCV	600mV/6V/60V±(0.5%+5d),600V±(0.8%+5d)
ACV	6V/60V±(1.0%+5d),600V±(1.2%+10d) True RMS
LoZ DC/AC V	1-600V±(2.0%+3d)
DCA	60A±(3.0%+15d)/600A±(3.0%+5d)
ACA	60A/600A±(2.5%+5d) True RMS
ResistanceΩ	600Ω/6KΩ/60KΩ/600KΩ/6MΩ ±(0.8%+5d),60MΩ±(1.2%+5d)
Capacitance	6nF±(5.0%+15d)/60nF/600nF/6μF/60μF/600μF/6mF ±(4.0%+5d),100mF±(5.0%+5d)
Temperature	-20°C~1000°C±(1.0%+3d),-4°F~1832°F±(1.0%+3d)
Frequency	(V) 600Hz/6kHz/60kHz/600kHz±(1.5%+5d), (A) 600Hz±(1.5%+5d)
Battery	1.5V AAA x 2 (not included)
Dimension	190 x 71 x 30 mm

MT-3202 3-3/4 Digital Clamp Meter



- ACV ACA true RMS measurement..
- NCV detection.
- Diode test.
- Continuity test.
- Data hold.
- Auto power off.
- Low battery indication.
- Back light.
- LED light.

ACCESSORIES

Temperature probe
Test lead
Storage bag

SPECIFICATIONS	
Max. jaw opening	30mm
DCV	400mV/4V/40V/400V/600V±(0.8%+5d)
ACV	4V/40V/400V/600V±(1.2%+5d) True RMS
ACA	4A±(3%+5d);40A/400A/600A±(2%+5d) True RMS
ResistanceΩ	400Ω/4KΩ/40KΩ/400KΩ/4MΩ/40MΩ±(1.2%+5d)
Capacitance	4nF±(3%+15d)/40nF/400nF/4μF/40μF/400μF/4mF±(3%+5d)
Temperature	-20°C~1000°C±(3%+5d),-4°F~1832°F ±(3%+5d)
Frequency	4Hz/40Hz/400Hz/4kHz/40kHz±(0.5%+5d), (A) 40Hz/400Hz/1kHz±(0.5%+5d)
Battery	1.5V AAA x 2 (not included)
Dimension	190 x 71 x 30 mm

MT-3110 3-5/6 Smart Digital Clamp Meter



CAT III 600V



- NCV detection.
- Continuity test.
- Data hold.
- Low battery indication.
- Back light.
- Auto selection.
- Simultaneous measurement.
- Dual display.

ACCESSORIES

Test lead
Storage bag

SPECIFICATIONS	
Max. jaw opening	25mm
ACA	6A /60A/400A±(2.5%+8d), 600A±(3.0%+10d), PEMAX: 900A ±(10%+10d)
ACV	6V/60V/600V±(0.8%+5d)
DCV	6V/60V/600V±(0.5%+3d)
Resistance	6KΩ/60KΩ/600KΩ/6MΩ/10MΩ±(0.8%+3d)
Frequency	10~1kHz±(1.0%+5d)
NCV	90~1000V 50/60Hz
Extra functions	Data hold,LCD backlight,Low Battery,Auto power off
Battery	1.5V AAAx2 (not included)
Dimension	188 x 68 x 38 mm

MT-3109 3-3/4 AC/DC Digital Clamp Multimeter



CAT II 600V



- Duty cycle.
- Diode test.
- Continuity test.
- Relative reference.
- Data hold.
- Auto power off.
- Low battery indication.

ACCESSORIES

Test lead
Storage bag

SPECIFICATIONS	
Max. jaw opening	30mm
DCV	400mV±(1.0%+3d), 4V/40/400V±(1.0%+1d), 600V±(1.0%+5d)
ACV	4/40/400V±(1.2%+5d), 600V±(1.5%+5d)
DCA	40A±(2.5%+5d), 400A±(2.5%+3d)
ACA	40A±(3.0%+8d), 400A±(3.0%+5d)
Resistance	400Ω±(1.2%+5d), 4KΩ/40KΩ/400KΩ±(1.0%+5d), 4MΩ±(1.2%+5d), 40MΩ±(1.5%+5d)
Frequency	10Ω/100Ω/1KΩ/10KΩ/100KΩ/1MHz ±(0.1%+5d), 10MHz (For reference only)
Capacitance	40n/400n/4μ/40μF ±(5.0%+10d), 100μF ±(6.0%+10d)
Battery	1.5V AAAx2 (not included)
Dimension	203 x 68 x 33 mm

MT-3102 3-1/2 2A Mini Digital Clamp Meter



CAT II 600V



- Diode test.
- Continuity test.
- Maximum value hold.
- Data hold.
- Auto power off.
- Low Battery indication.

ACCESSORIES

Test lead
Temperature probe
Storage bag

SPECIFICATIONS	
Max. jaw opening	30mm
ACA	2A±(3.0%+15d)≤0.4A±(4.0%+20d), 20A±(2.0%+10d)≤0.4A±(3.0%+15d), 200/400A±(2.0%+5d)
ACV	2/20/200V±(1.2%+5d), 600V±(1.5%+5d)
DCV	200mV±(0.8%+5d), 2/20/200V±(0.8%+3d), 600V±(1.0%+5d)
Resistance	200Ω±(1.2%+5d), 2kΩ/20kΩ/200kΩ±(1.0%+3d), 2MΩ ±(1.2%+5d), 20MΩ±(1.5%+5d)
Temperature	-40~0°C±(3.0%+4d), 0~400°C±(1.0%+3d), 400~1000°C ±(2.0%+10d), -40~32°F±(3.0%+8d), 32~752°F±(1.0%+6d), 752~1832°F±(2.0%+18d)
Battery	1.5V AAAx3 (not included)
Dimension	203 x 68 x 33 mm

MT-3266 3-1/2 Hand Held Digital Clamp Meter



CAT II DC 1000V
CAT II AC 750V



- Continuity test.
- Data hold.
- Low battery indication.

ACCESSORIES

Test lead
Storage bag

SPECIFICATIONS	
Max. jaw opening	50mm
ACA	200/1,000A±(3.0%+5d)
ACV	750V±(1.2%+4d)
DCV	1,000V±(0.8%+2d)
Resistance	200Ω±(1.0%+3d), 20kΩ±(1.0%+1d)
Battery	NEDA1604/6F22 (9V) x 1pcs(not included)
Dimension	230 x 70 x 37 mm

TOOL KITS
TEST INSTRUMENTS
SOLDERING & DESOLDERING
FIBER OPTICS
GRIPPERS
PRECISION PLIERS & CUTTERS
ELECTRICAL PLIERS & CUTTER
STRIPPERS
PUNCH DOWN TOOLS
ALIGNMENT TOOL & SCREWDRIVERS
HEX KEY WRENCHES

NT-320/NT-310/NT-309/NT-306/NT-305N Voltage Tester**NT-320**
NEW**CAT III 1000V****NT-310**
NEW**CAT III 1000V****NT-309****CAT IV 1000V****NT-306****NT-305N**
NEW**ACCESSORIES**

Battery DC 6V (LR41 DC1.5V x 4)

FEATURES	NT-320	NT-310	NT-309	NT-306	NT-305N
Material			ABS		
Test Voltage range	AC 12V~300V(5%+3d), 50/60Hz	AC 12V~1000V 50/60Hz	AC 12V~1000V, 50/60Hz	AC 90V~1000V	AC 70V~250V, DC 12,36,55V
NCV	-		●		-
LED light			●		
Auto power off	5 mins after no use	5 mins after no use	3 mins after no use	-	-
Battery	1x 1.5V AAA	2x1.5V AAA	2x 1.5V AAA	2x 1.5V AAA	1.5V LR41(AG3) x4
OAL (mm)	147	165	156	153	142

NT-1933/NT-1934 Receptacle Tester**NT-1933****NT-1934**

- Tests for correct wiring, open ground, reverse polarity, open hot, open neutral, hot on neutral, hot and ground reversed with open hot and ground fault interruption in 3-wire, 120VAC circuits.
- Proper operation GFI receptacles testing.

NT-6350

Mini Laser Distance Measurer



NEW



- Aluminum shell.
- 50m range.
- Electronic angle.
- Auto power off.

ACCESSORIES

Type-C USB cable x1
Lanyard x1

SPECIFICATIONS

Range	0.05-50m
Range accuracy	±1.5mm (or dx0.005%)
LCD screen	VA display
Laser type	620~670nm, <1mW
Laser level	Class II
Laser off	No operate 30 seconds
Auto off	No operate for 2 minutes
Single measuring	Yes
Continuity measuring	Max & Min values
Area & Girth measurement	Yes
Volume measurement	Yes
Wall area survey	Yes
Pythagorean measurement	Yes
Unit switch	m/ft/in/ft+in
Benchmark switch	Top base/Bottom base
Review records	50 groups
Electron Angle	0°~90°
Working temperature	0°C~40°C
Storage temperature	-20°C~60°C
Battery	3.7V 320mAh Lithium
Dimension	98x30x19mm
Weight	54g

NT-6370

Laser Distance Measurer



NEW



- 70m range.
- Two bubble for leveling.
- Auto power off.
- 99 groups review records.

ACCESSORIES

Lanyard x1

SPECIFICATIONS

Range	0.05-70m
Range accuracy	±1.5mm (or dx0.005%)
LCD screen	2.0-inch HD screen
Laser type	620~670nm, <1mW
Laser level	class II
Bubble	2, lateral & vertical
Laser off	No operate 30 seconds
Auto off	No operate for 3 minutes
Single measuring	Yes
Continuity measuring	Max & Min values
Area & Girth measurement	Yes
Volume measurement	Yes
Wall area survey	Yes
Pythagorean measurement	Yes
Countdown	Yes
Add & subtraction measurement	Yes
Unit switch	m/ft/in/ft+in
Benchmark switch	front /end benchmark
Beep	Yes
Data storage	99 set
Working temperature	0°C~40°C
Storage temperature	-20°C~60°C
Battery	1.5V AAA x3 (not included)
Dimension	120x52x29mm
Weight	95g

TE-6305F/A DC Power Supply**NEW****TE-6305F****TE-6305A**

- Two level of control for current & voltage.
- Short circuit, over temperature and over load protection.
- High quality SMD process.
- Encoder adjustment.

ACCESSORIES

Power cord x1
Alligator leads x1

FEATURES	TE-6305F	TE-6305A
Input voltage	220~240V 50/60Hz	104~127V 60Hz
Standard plug	F	A
Output voltage	0~30V DC	
Output current	0~5 A DC	
Display error of voltage	±0.5%+5 digits	
Display error of current	±0.5%+5 digits	
Line regulation	CV ≤ 0.1%+3mV ; CC ≤ 0.2%+5mA	
Load regulation	CV ≤ 0.1%+10mV ; CC ≤ 0.5%+10mA	
Ripple and noise	CV ≤ 5mV (rms) ; CC ≤ 20mA (rms)	
USB port output	DC 5V/2A (max)	
Power	150W max	
Fuse	3.15A 250V, Φ5.0x30mm	
Dimension	190x155x80mm	
Weight	740g	

TE-5305B DC Power Supply

- Protective design.
- High quality SMD process.
- Two level control for current & voltage.
- Auto temperature & circuit protection system.

ACCESSORIES

Power cord



	SPECIFICATIONS
Input voltage	AC220V ±10%, 50/60 HZ
Output voltage	0~30V
Power	150W
Display error of voltage	±0.2%+2 digits
Display error of current	±1.0%+2 digits
Line regulation	≤ 0.01%+3mV
Load regulation	≤ 0.01%+5mV
Ripple voltage	≤ 1.0mV(rms)
Output current	0~5A
Line regulation	≤ 0.2%+3mA
Load regulation	≤ 0.2%+3mA
Ripple current	3.0mA(rms)
Operating condition	Working:0~40°C ; Storage:-10~40°C <90%RH
Dimension	280x136x160mm
Weight	5.3kg

Environmental Meter

MT-4606 Infrared Thermometer



- °C/°F selection.
- 0.10~1.00 emissivity adjustable.
- Auto power off.
- Low battery indication.
- Data hold.
- Max. record.
- Color screen.

SPECIFICATIONS

Temperature Range	-50~550°C (-58~1022°F)
Accuracy	≤100°C ±2°C , >100°C ±2%
Distance Spot Ratio	12 : 1
Emissivity	Adjustable (0.1 to 1.0)
Laser Class	Class II , <1mW
Repeatability	±1°C or ±1%
Unit Selection	°C / °F
Resolution	0.1°C (0.1°F)
Response time	0.5S
Wavelength	8-14μm
Operating condition	Working :0-50°C, 10~95%RH; Storage: -20-50°C
Battery	9V battery (6F22)
Dimension	152 x 87 x 40mm
Weight	118g (not include battery)

MT-4612 Infrared Thermometer



- 0.10~1.00 emissivity adjustable.
- Dual laser for accurate aiming.
- °C/°F selection.
- Auto power off.
- Low battery indication.
- Data hold.
- Max./Min./Average/Difference record.
- High/Low temperature alarm.
- Backlight.

SPECIFICATIONS

Temperature range	-50°C~580°C(-58°F ~1076°F)
Accuracy	±2°C or ±2%°C
Distance Spot Ratio	16 : 1
Emissivity	Adjustable (0.1 to 1.0)
Laser class	Class II , <1mW
Response time	0.5S
Wavelength	8-14μm
Repeatability	±1°C or ±1%°C
Resolution	0.1°C
Data memory	9 memories
Laser target point	Dual Laser / can be selected on / off
Operating condition	Working :0-50°C, 10~95%RH; Storage: -20-50°C
Battery	6F22(9V) (not included)
Dimension	175 x 130 x 45mm
Weight	204g (Not include battery)

NT-311 Digital Temperature Humidity Meter



- Memory function.
- Wall mount or desk-top stand.
- 8-Minutes snooze.
- °C / °F switch.

SPECIFICATIONS

Temperature range	-10°~50°C ± 1°C, (14°F- 122°F ±1.8°F)
Humidity range	10%-95% RH±5%
Resolution	0.1°C / 1%RH
Battery	1.5V AAA x1 (not included)
Dimension	97x94x23.5
Weight	100g

NT-312 Digital Temperature Humidity Meter



- Memory function.
- Wall mount or desk-top stand.
- 8-Minutes snooze.
- °C / °F switch.

ACCESSORIES

Outdoor temperature sensor

SPECIFICATIONS

Temperature range	Indoor: -10°~ 50°C ±1°C, (14°F~122°F ±1.8°F) Outdoor: -50°~70°C ±1°C, (-58°F~158°F ±1.8°F)
Humidity range	10%-95% RH±5%
Resolution	0.1°C / 1%RH
Battery	1.5V AAA x1 (not included)
Dimension	97x94x23.5
Weight	115g

TOOL KITS

TEST INSTRUMENTS

SOLDERING & DESOLDERING

FIBER OPTICS

GRIPPERS

PRECISION PLIERS & CUTTERS

ELECTRICAL PLIERS & CUTTER

STRIPPERS

PUNCH DOWN TOOLS

ALIGNMENT TOOL & SCREWDRIVERS

HEX KEY WRENCHES

MT-4615 Anemometer

- Analog bar graphic.
- Variety of units. Backlight.
- Max/Min. value.
- Low Battery indication.
- Auto power off.
- Data hold.

**ACCESSORIES**

Storage bag x1

SPECIFICATIONS

Measuring range	0.8~40m/s
Accuracy	0.8~30m/s, 1.4~108km/h, 1.3~98.5ft/s, 0.8~58.3knots, 0.9~67.2mil/h, 78~5900ft/m, $\pm(2.0\% + 50D)$; 30~40m/s, 108~144km/h, 98.5~131.2ft/s, 58.3~77.7 knots, 67.2~90mil/h, 5900~7874 ft/m
Resolution	0.01m/s, 0.01km/h, 0.01 ft/s, 0.01knots, 0.01mile/h, 1ft/m
Unit	Air Velocity: m/s, km/h, mil/h, ft/m, ft/s, knots Air Volume: CMS (m ³ /s), CMM: m ³ /min, CFM: (ft ³ /min), 30~40m/s
Sampling time	0.4s
Operating condition	Working: 0°C~40°C; Storage:-20°C~80°C ; <85%RH
Fan operation	-20°C~80°C ; <95%RH
Operating altitude	Max. 2000m
Battery	9V 6F22 (not included)
Dimension	170 x 85 x 40mm
Weight	154g

MT-4617LED LED Light Intensity Meter

- Auto and manual range.
- Zero calibration.
- Relative peak value.
- Max/Min. value.
- Low battery indication.
- Auto power off.
- Data hold.
- Over-load indication.

**ACCESSORIES**

Storage bag x1

SPECIFICATIONS

Range	20, 200, 2000, 20000, 200000 Lux, 20, 200, 2000, 20000 FC
Ring spectral range	320~730nm
Unit selection	Lux,FC (Footcandles)
Sensor	Silicon photodiode
Sampling time	≥ 2 times/sec.
Auto power off	10 mins after no use
Operation sound	Selection
Operation environment	Working: -10~50°C, 85%RH; Storage:-10~50°C, 70%RH
Operating altitude	Max. 2000m
Accuracy	$\pm 3\%$ (calibrated to standard incandescent lamp and LED at 2,854K), $\pm 6\%$ (calibrated at other visible light source)
Battery	9V 6F22 (not included)
Dimension	170x85x45mm
Weight	164g

MT-4616 Temperature/ Humidity/ Dew point Meter

- 99 data memories.
- Variety of units.
- Backlight. Max/Min. value.
- Low Battery indication.
- Auto power off. Data hold.

**ACCESSORIES**

Storage bag x1

SPECIFICATIONS

Temperature range	-20~60°C(- 4°F~140°F)
Temperature accuracy	$\pm 1^\circ\text{C}(0\sim 45^\circ\text{C})$, $\pm 1.5^\circ\text{C}(-20\sim 0^\circ\text{C}, 45\sim 60^\circ\text{C})$
Humidity range	0~100%RH
Humidity accuracy	$\pm 3\%(20\sim 80\%)$, $\pm 4\%(0\sim 20\%, 80\sim 100\%)$
Wet Bulb temperature range	-20~60°C(-4~140°F)
Wet bulb temperature accuracy	$\pm 1^\circ\text{C}(0\sim 45^\circ\text{C})$, $\pm 1.5^\circ\text{C}(-20\sim 0^\circ\text{C}, 45\sim 60^\circ\text{C})$
Dew point range	-50~60°C(-58~140°F)
Dew point accuracy	$\pm 1^\circ\text{C}(0\sim 45^\circ\text{C})$, $\pm 1.5^\circ\text{C}(-50\sim 0^\circ\text{C}, 45\sim 60^\circ\text{C})$
Resolution	0.1C/F ; 0.1%
Battery	AAA 1.5V x 4 (not included)
Dimension	184 x 60 x 29mm
Weight	120g

MT-4618 Sound Level Meter

- Max./Min.value.
- Data hold.
- Auto range.
- Auto power off.
- Backlight.

**ACCESSORIES**

Storage bag x1

SPECIFICATIONS

Range	30—130dBA, 35—130dBC 30—80db, 40—90db, 50—100db, 60—110db, 70—120db, 80—130db, 30—130 db is auto range
Accuracy	$\pm 1.5\text{dB}$ (94dB@1KHz), $\pm 5\text{dB}$ (94dB@8KHz)
Resolution	0.1dB
Response frequency	30Hz — 8KHz
Dynamic sound pressure	50 dB (at each range); FAST 125ms, SLOW 1sec
Frequency weighting	A and C type
Sensor	Polarized condenser microphone
Sampling time	2 times/sec., Analog 20 times/sec.
Operating environment	Working: 0~40°C, 80%RH; Storage:-10~60°C, 70%RH
Battery	1.5V AAA battery x 4 (not included)
Dimension	193 x 60 x 29mm
Weight	190g

SOLDERING & DESOLDERING



SOLDERING STATIONS 51

DESOLDERING 73

SOLDERING IRONS 61

REPLACEMENT TIPS 79

HOT AIR GUNS 69

Soldering Stations

SS-988B/E 6 IN 1 Multifunction Soldering Iron/Desoldering Station



SS-988B



SS-988E

- 6 in 1, multifunction repair station.
- Smart & stable temperature control.
- Auto sleep, energy saving.
- Rapid ceramic heating element.
- High suction, efficient desoldering.
- Infrared sensor cleaner : Automatic solder removal and oxide removal.



ACCESSORIES

- Activated carbon filter x2(1pc mounted)
- Filter sponge x6(1pc each mounted)
- Cleaning pins x3
- Desoldering gun nozzles x3
- Soldering wire reel: 1.0 mm soldering wire/10g
- 2-in-1 soldering iron stand (with cleaning ball and sponge)

REPLACEABLE PARTS

- Soldering iron: 5SS-988-SI
- Soldering tip: 5SI-216N series (P.79)
- Soldering iron heater: 9SS-988-HT
- Desoldering gun: 5SS-989-DG
- Desoldering gun heater: 5SS-988-H



Tip Cleaning



LED Light



USB Charging



Adjustable Absorber

FEATURES	SS-988E	SS-988B
Voltage	AC110-120V 60Hz	AC220-240V 50Hz
Soldering iron / Desoldering gun power	250W(Max.)	
Soldering iron / Desoldering gun display	LCD (Dual color backlight)	
Soldering iron / Desoldering sleep mode	Idle for 10min, with temperature at 200°C	
Soldering iron / Desoldering gun °C/°F display	Yes	
Soldering iron power	60W(Max.130W) (DC 18V)	
Soldering temperature	160°C ~ 480°C(320°F -896°F)	
Desoldering gun heater power	130W (Max)(DC 18V)	
Desoldering gun pump power	50W	
Desoldering gun pump power temperature	160°C ~ 480°C(320°F -896°F)	
Desoldering gun suction	>600mm Hg	
Smoke absorber power	5W	
Smoke absorber air volume	1.0m3/min	
Tip cleaner solder removal	Φ7mm	
Tip cleaner oxide removal	Φ10mm	
LED light	<5W, 100Lm, 6000 Kelvin	
USB output	DC5V 1A	
Packaging dimensions(mm)	385x280x205mm	
Packaging weight(kg)	About 5.4kg	

SS-989B/E 2 In 1 SMD Hot Air Rework Station



SS-989B



SS-989E

- ESD safe design.
- Closed circuit sensor.
- Silicone hand-piece cord wire heat-resistant up to 200°C.
- AWG 18 UL certified wire.
- Individual function start.
- Auto cool off.



Quick change design



Fast heating



High work efficiency



Large air volume

ACCESSORIES

Soldering stand x1
Nozzle x 3

REPLACEABLE PARTS

Soldering tip: 5SI-216N series (p.79)
Soldering iron: 9SS-900N-SI
Hot air gun: 9SS-900NB/9SS-900NE
Soldering iron heater: 9SS-900N-HT
Hot air gun heater: 5SS-989NB/5SS-989NE
Nozzle: 9SS-900 series (p.79)

FEATURES	SS-989E	SS-989B
Power input	AC110V~120V 60Hz	AC220V~240V 50Hz
Power consumption	700W	
Soldering power	60W	
Heating element	Alumina ceramic heating element	
Soldering iron temperature	200°C ~ 480°C (392°C ~ 896°F)	
Hot air temperature	Room temperature ~ 480°C (896°F)	
Hot air heating element	Metal heating core	
Equipment noise	45dB	
Temperature display	LED	
Pump/motor type	Diaphragm pump	
Air capacity	24L/min (max)	
Dimension (mm)	255(L)x190(W)x140(H)mm	
Weight	4.2kg	

* For packing info please refer to the index at the back.

SS-956B Smart Rework Station with Vacuum Pickup



- ESD safe design.
- Closed circuit sensor.
- Large LCD display.
- Silicone hand-piece cord wire heat-resistant up to 200°C.
- AWG 18 UL certified wire.
- All in one PCB design.
- Interchangeable hot air nozzles with high commonality.



All in 1 PCB
Metal screws fixed.



SMD rework
high work efficiency



Calibration
function



100g
suction power

ACCESSORIES

Suction cup x4
Opening lever(width) x2
Nozzle x3

REPLACEABLE PARTS

Nozzle: 9SS-900 series (p.79)

SPECIFICATIONS

Power input	AC220V~240V 50Hz
Power consumption	600W
Heating element	Metal heating core
Temperature	Room temperature~480°C(896°F)
Temperature calibration	0~699°C (0~999°F), adjustable
Dimensions	250(L) x 230(W) x 170(H)mm (Handle, Holder for hot air gun & suction are included)
Equipment noise	<50dB
Temperature display	LCD (60mm x 35mm, Backlight)
°C/°F switch	Yes
Pump/Motor type	Diaphragm pump
Air capacity	24L/min(Max)
Auto sleep function	YES
Auto cooling function	YES
Suction capacity	100g
Weight	3.2kg

SS-979B/E 2 In 1 SMD Hot Air Rework Station



SS-979B



SS-979E

- Adjustable 8 airflow control.
- Hot air high power 700W consumption.
- Low noise ≤ 45 dB.
- Gentle airflow no damage to component.
- Auto sleep.
- Turbo fan.
- Fast heat.



Precise output control



Calibration function



SMD Rework High Work Efficiency



Fast heating

ACCESSORIES

- Soldering iron x1
- Soldering iron stand x1
- Hot air gun x1
- Nozzle x3

REPLACEABLE PARTS

- Soldering tip: 5SI-216N series (p.79)
- Soldering heater : 9SS-900N-HT
- Nozzle: 9SS-969-A1 (ID: 4.3mm)
- 9SS-969-A2 (ID: 7.4mm)
- 9SS-969-A3 (ID: 11.2mm)

FEATURES	SS-979E	SS-979B
Power input	AC110V~120V 60Hz	AC220V~240V 50Hz
Power consumption		760W
Soldering iron output voltage		24V~
Hot air output voltage	110V~120V	220V~240V
Soldering power		60W
Soldering iron heating element		Alumina ceramic heater
Hot air heating element		Metal heating core
Soldering iron temperature		200-480°C
Hot air temperature		100-500°C
Equipment noise		<45dB
Temperature display		LED
Air volume		120L/min(Max)
Fuse type	250V / 8A	250V / 5A
Dimension (mm)		170x170x140 (include bracket)
Weight (with soldering iron)		2.5Kg

TOOL KITS
TEST INSTRUMENTS
SOLDERING & DISOLDERING
FIBER OPTICS
GRIPPERS
PRECISION PLIERS & CUTTERS
ELECTRICAL PLIERS & CUTTER
STRIPPERS
PUNCH DOWN TOOLS
ALIGNMENT TOOL & SCREWDRIVERS
HEX KEY WRENCHES

SS-968B LCD Smart Hot Air Rework Station

- ESD safe design.
- Closed circuit sensor.
- Large LCD display.
- Silicone hand-piece cord wire heat-resistant up to 200°C.
- AWG 18 UL certified wire.
- Interchangeable hot air nozzles with high commonality.
- Button adjustment.
- All in one PCB design.

SPECIFICATIONS

Voltage	AC220V~240V
Power consumption	600W
Heating element	Metal heating core
Temperature	Room temperature~480°C (896°F)
Temperature calibration	0~699°C (0~999°F), adjustable
Equipment noise	<50dB
Temperature display	LCD (60mm x 35mm, Backlight)
°C/°F switch	Yes
Pump/Motor type	Diaphragm pump
Air capacity	24L/min(Max)
Auto sleep function	YES
Auto cooling function	YES
Dimensions	250(L) x 215(W) x 170(H)mm
Weight	3.2kg

REPLACEABLE PARTS

Nozzle: 9SS-900 series (P.79)
Hot air gun heater : 5SS-989NB/5SS-989NE

ACCESSORIES

Nozzle x3

SS-969B/E SMD Rework Station

- Closed circuit sensor.
- Silicone hand-piece cord wire heat-resistant up to 200°C.
- AWG 20 (0.5 mm²) UL certified wire.
- Interchangeable hot air nozzles with high commonality.
- Knob adjustment.
- All in one PCB design.

REPLACEABLE PARTS

SS-969E hot air gun:
5SS-969NE-HG (AC110~120V)
SS-969B hot air gun:
5SS-969NB-HG (AC220~240V)
Nozzle: 9SS-969-A1, 9SS-969-A2,
9SS-969-A3

ACCESSORIES

Nozzle x3

FEATURES	SS-969E	SS-969B
Input voltage	AC110V~120V 60Hz	AC220V~240V 50Hz
Power consumption	700W	
Heating element	Metal heating core	
Temperature	100°C ~ 450°C (212°F~842°F)	
Equipment noise	<45dB	
Temperature display	LED	
Air volume	120L / min (Max.)	
Fuse type	250V / 8A	250V / 5A
Power cord length	1.2m(3 core cord ground plug)	
Overall package	280 x 185 x 170mm	
Machine size	170 x 170 x 140mm	
Weight	1.6 kgs	

SS-955B

Automatic Solder Feeder Soldering Station



NEW



REPLACEABLE PARTS

Soldering iron tip: 5SI-216N series (p.79)
Heater: 9SS-900N-HT
Soldering iron: 5SS-955-SI

ACCESSORIES

Foot switch, soldering iron, soldering iron frame (with sponge), handle bracket, solder wire support (include shaft), elbow tube (10cm)/ nozzle $\Phi 1.2\text{mm}$ & $\Phi 1.5\text{mm}$ each one, straight tube (17.5cm)/nozzle $\Phi 1.8\text{mm}$, screwdriver

SPECIFICATIONS

Automatic solder feeder voltage	220V~240V 50Hz
Automatic solder feeder power	Soldering iron (60W)
Automatic solder feeder soldering iron temperature	200~480°C
Automatic solder feeder display	LCD
Automatic solder feeder setting	Encoder knob
Automatic solder feeder calibration function	Y
Automatic solder feeder password lock function	Y
Automatic solder feeder restore settings	Y
Automatic solder feeder sleep function	Y
Automatic solder feeder transformer	60W (copper wire)
Automatic solder feeder anti static socket	$\Phi 4.2\text{mm}$ (impedance 1MQ)
Soldering iron working voltage	AC24V
Solder wire feed applicable solder wire	$\Phi 0.5-1.5\text{mm}$
Solder wire feed control	Foot / hand
Solder wire feed working mode	Manual 0 / auto 1-9
Solder wire feed wire feeding length(LEN)	0~99.5mm
Solder wire feed wire feeding speed(SPD)	1~40mm/s
Solder wire feed Interval time(INR)	0~9.5S
Solder wire feed Return wire length(RET)	0~19.5mm
Automatic solder feeder dimension/Weight	270*230*175mm/ about 3.5kg

SS-331B/E

LCD Desoldering Station



SS-331B



SS-331E



REPLACEABLE PARTS

Desoldering gun: 5SS-331N1-DG
Heater: 5SS-331N1-H
Nozzle set: 5SS-331N-NZ

ACCESSORIES

Nozzle x3
Cleaning tool x 3
Filter sponge x 4

- Large LCD display.
- Built-in high power 600mm-Hg air pump.
- Vacuum indicator.
- °C and °F selection.
- Transparent solder tube.

FEATURES	SS-331E	SS-331B
Input voltage	120V 60Hz	220V~240V 50Hz
Power consumption	140W	
Soldering power	90W	
Heating element	Ceramic heater	
Temperature	160°C ~ 480°C	
Sleep mode	Approximately 10 minutes if not use	
Control system	Microprocessor	
Vacuum pump system	Air pump motor	
Vacuum pressure	>600mm hg	
Connecting cord/Hose length	105cm	
Power cord length	1.2m(3 core cord ground plug)	
Station size	172 x 135 x 190mm	
Weight	approx 3kgs	

* For packing info please refer to the index at the back.

SS-256B/ SS-257B/ SS-259B LCD Smart Soldering Station



SS-256B



SS-257B



SS-259B

- ESD safe certification.
- Resettable Fuse Protection.
- Temperature Calibration Function.
- USB Power Output.
- Shuffle Knob Design for Quick Setting.
- 3 Data Memories.
- Auto Sleep and Wake Up Function.



SS-259B
• Professional model



Shuffle knob



Large LCD display with
backlight



USB power supply

SS-256B
• Standard model

SS-257B
• Advanced model

REPLACEABLE PARTS

- SS-256/257 soldering tips: 5SI-216N series (P.79)
- SS-259 soldering tips: 5SI-259N series (P.79)
- SS-256B heater: 9SS-900N-HT
- SS-257B heater: 9SS-257-HT
- SS-258B heater: 9SS-259-HT
- SS-256B soldering iron: 9SS-256-SI
- SS-257B soldering iron: 9SS-257-SI
- SS-259B soldering iron: 9SS-259-SI



SPECIFICATIONS	SS-256B	SS-257B	SS-259B
Input voltage	AC 220~240V 50Hz	AC 220~240V 50Hz	AC 220~240V 50Hz
Power consumption	60W	75W	90W
Output voltage	24VAC	25VAC	25VAC
Display	LCD 73mmX40mm, Backlight		
Heating element	Alumina ceramic	High end quad-wire heater (stainless/Cr-Ni)	High end silver alloy heater
Temperature	200~480°C(392°F~896°F)	30~500°C(86~932°F)	30~500°C(86~932°F)
Temperature calibration	100~699°C(212~1290°F) Adjustable	0~699°C(32~1290°F) Adjustable	0~699°C(32~1290°F) Adjustable
Sleep mode	OFF/1-240min adjustable	OFF/1-360min adjustable	OFF/1-360min adjustable
Temperature of sleep mode	200°C(392°F)	30~400°C(86~752°F)	30~400°C(86~752°F)
Control system	Microprocessor-controlled		
Temperature stability	±2°C/±36°F (no load)		
USB port output	DC 5V/1A		
Memory	3 sets		
Tip-to-Ground resistance/potential	≤2Ω / ≤2mV		
Station size(mm)	180x150x106		

SS-306B

Temperature-Controlled Soldering Station



NEW



- High power, heating fast.
- Accurate temperature control.
- ESD safe design.
- Lead free process.

REPLACEABLE PARTS

Soldering tips: 5SI-216N series (p.79)
 Heater: 9SS-306-HT
 Soldering iron: 9SS-306-SI

ACCESSORIES

Soldering iron x1
 Soldering iron stand x1

SPECIFICATIONS

Voltage	220~230V / 50Hz
Power consumption	75W
Output voltage	24 VAC
Display	Analog
Heater	Ceramic heater
Temperature	200°C- 480°C (392°F-896°F)
Station size(mm)	115X90X140

SS-208B/E Temperature-Controlled Soldering Station



SS-208B



SS-208E

NEW



- LCD display with backlight.
- Custom temperature setting, lock temp setting, digital calibration, sleep function.
- Ceramic heating core, 75W maximum power.
- Copper transformer, durable and stable.
- ESD safe design.
- Lead free process

REPLACEABLE PARTS

Soldering tip: 5SI-216N series (P.79)
 Heater: 9SS-208-HT
 Soldering iron: 9SS-208-SI

ACCESSORIES

Soldering iron x1
 Soldering iron stand x1

Model No.

SS-208B

SS-208E

Model No.	SS-208B	SS-208E
Voltage(V)	AC 220~240V	AC110~120V
Display	LCD (white backlight)	
Power consumption	75W	
Output voltage	24V~	
Heater	Ceramic heater	
Temperature	200°C-480°C(392°F-896°F)	
Preset temperature	3 sets	
Other functions	Temp lock, °F/°C selection, Auto sleep	
Standard plug	B type	E type
Fuse	250V / 2A	
Station size(mm)	145x90x120	

* For packing info please refer to the index at the back.

SS-206B/E · SS-207B/E Temperature-Controlled Soldering Station



SS-206B



SS-206E



SS-207B



SS-207E

- ESD safe design.
- Stackable structure save space.
- Temperature range 200°C ~ 480°C.
- Heat resistant hand-piece.
- Aerospace grade metal plug.
- °C and °F double scale.



SS-207 Digital Type



SS-206 Analog Type

REPLACEABLE PARTS

Soldering tip: 5SI-216N (p.79)
Heater: 9SS-900N-HT
Soldering iron: 9SS-900N-SI

ACCESSORIES

Replacement heater x1
Soldering iron x1

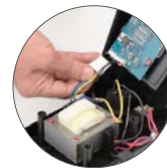
Modular design
for easy repair

High quality assembly

SPECIFICATIONS	SS-206B	SS-206E	SS-207B	SS-207E
Voltage	220~240V / 50Hz	110~120V / 60Hz	220~240V / 50Hz	110~120V / 60Hz
Power consumption	60W			
Output voltage	24 VAC			
Display	Analog		Digital	
Heater	Alumina ceramic heating element			
Temperature	200°C- 480°C (392°F-896°F)			
Station Size(mm)	145X90X120			

SS-596A/F Solder Smoke Absorber



NEW



SS-596A SS-596F



ACCESSORIES

- Primary Filter Cotton x3
- Silicone Smoke Hood x1
- Corrugated pipe(Φ64x210mm) x1
- Air guide board x1

- Multi-layer filtration for rapid purification
- Compact size, with powerful airflow.
- Adjustable fan speeds, with LED display in speed setting.
- With a flexible hose adjustable in different length and angle.
- The air purifier is low voltage.

FEATURES	SS-596A	SS-596F
Working voltage	DC12V	
Power	15W	
Maximum inhalation volume	90 L/min	
Noise	<60dB	
Fan speed	10-100 (digital setting)	
Display method	LED (white light)	
Adapter Input	100V-240V 50/60Hz 0.8A	
Adapter output	12VDC 2.0A 24W	
Size	205x250x90mm (Excluding Corrugated pipe)	
Weight (Approx)	1.35kg	

SS-593B Smoke Absorber



- Portable and desktop design.
- Low noise operation.

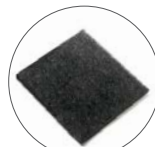

5SS-593-F

Filter is made of urethane foam with refined, activated, high absorption carbon

ACCESSORIES

- Activated-carbon filter 5SS-593-F x2

SPECIFICATIONS

Input voltage	220-240V 50Hz
Consumption	23W
Capacity	1m ³ /min(max)
Size(mm)	220 x 270 x 168

SS-202A/F Mini Soldering Station



SS-202A SS-202F



- Super slim pen-like style soldering iron.
- Fast heating.

ACCESSORIES

- Soldering iron 9SS-202-SI x1
- Soldering tip 9SS-202-R0.3 x1
- Spring iron frame x1



FEATURES	SS-202A	SS-202F
Input voltage	110-120V	220-240V
Consumption	10W (max)	
Output voltage	AC12V	
Temp.	100-450°C (212-842°F)	
Station size(mm)	115 x 64 x 70	
Weight	570g	

Soldering Irons

SI-186NA/F Digital Control Soldering Iron

NEW

SI-186NA



SI-186F



Protection cap

Stainless Tube

- Digital temperature control.
- Temperature correction.
- Ceramic heater.
- Rapid heating and recovery.

REPLACEABLE PARTS

 Soldering tip: 5SI-216N series (p.79)
 Heater: 9SI-186N-HT

ACCESSORIES

Protection cap x1

MODEL	Voltage	Consumption	Temp.	Heater	OAL (mm)
SI-186NA	110-240V 50Hz	60W	180-500°C	Ceramic heater	205
SI-186F	220-240V 50Hz				

SI-131B 80W Temperature Controller Soldering Iron



- Stainless steel barrel.
- Ventilation hole.
- K type temperature control sensor.

REPLACEABLE PARTS

 Soldering tip: 5SI-131 series (p.79)
 Heater: 5SI-131-HT

Voltage	Consumption	Temp.	Heater	OAL (mm)
220-240V 50Hz	80W	200-450°C	Ceramic heater	240

PK-918F Temperature Adjustable Soldering Iron Kit

NEW

- 11 in 1 soldering kit.

REPLACEABLE PARTS

Soldering tip: 5SI-216N series (P.79)

ACCESSORIES

 Soldering iron, Desoldering pump,
 Solder, Rosin, Soldering tip x5, Soldering
 iron stand, Sponge, Tweezers

Voltage	Consumption	Temp.	Heater	OAL (mm)
220-240V 50Hz	60W (max)	250-500°C	Ceramic heater	120

SI-130A-20 SI-130B-20 Ceramic Soldering Iron



SI-130A-20 SI-130B-20



- Lead free.
- Stainless steel barrel.

REPLACEABLE PARTS

Soldering tip: 5SI-216N series (P.79)
Heater: 9SI-130B-20, 9SI-130A-20

MODEL	Voltage	Consumption	Temp.	Heater	OAL (mm)
SI-130A-20	110-120V	12W	410°C ± 10%	Ceramic heater	170
SI-130B-20	220-240V				

ACCESSORIES

Protection cap x1
Iron holder x1

SI-130B-25 Ceramic Soldering Iron



- Lead free.
- Stainless steel barrel.

REPLACEABLE PARTS

Soldering tip: 5SI-216N series (P.79)
Heater: 9SI-130B-25

Voltage	Consumption	Temp.	Heater	OAL (mm)
220-240V	14W	450°C ± 5%	Ceramic heater	170

ACCESSORIES

Protection cap x1
Iron holder x1

SI-139A/B Dual Wattage Soldering Iron



SI-139A SI-139B



- Displays working condition, avoid accident.

REPLACEABLE PARTS

Soldering tip: 5SI-139 series (p.79)
Heater: 9SI-139A-HT/9SI-139B-HT

MODEL	Voltage	Consumption	Temp.	Heater	OAL (mm)
SI-139A	110-120V	15W/30W	300°C/480°C ± 10%	Ceramic heater	220
SI-139B	220-240V				

SI-125A-20 Mini Soldering Iron



- Light weight.
- Safe stopper design.

REPLACEABLE PARTS

Soldering tip: 5SI-125T series (p.79)

Voltage	Consumption	Temp.	Heater	OAL (mm)
110-120V	20W	410°C ± 10%	Ceramic heater	168

ACCESSORIES

Protection cap x1
Iron holder x1

1PK-SC109NB Quick Heat Ceramic Soldering Iron



- Ideal for professional service or light electrical work.

REPLACEABLE PARTS

Soldering tip: 9SC116N series (p.79)

Voltage	Consumption	Temp.	Heater	Size (mm)
220-240V	20/40W	400°C ± 10%	Ceramic heater	Ø28 x 260

ACCESSORIES

Protection cap x1

8PK-SC116NB Convertible Soldering Iron / Gun



- Wide range of applications from sheet metal to PC board.

REPLACEABLE PARTS

Soldering tip: 9SC116N series (p.79)

Voltage	Consumption	Temp.	Heater	Size (mm)
220-240V	20/40W	400°C ± 10%	Ceramic heater	185 x 110 x 23

ACCESSORIES

Protection cap x1

8PK-S120N Series**Soldering Iron**

Blue: 30W / 440°C



Red: 40W / 480°C



Yellow: 60W / 520°C

Beehive heat
sink aperture

- Lead free.
- Power consumptions classified in different colors of handle
- Beehive heat sink aperture.
- Terminals added design.

REPLACEABLE PARTS

Soldering tip: SI-S120T series (P.79)

Heater: 5PK-S120N series

MODEL	Voltage	Con- sumption	Temp.	Heater	Replacement heater	OAL (mm)
8PK-S120NAD-40	110- 120V	40W	480°C ± 10%	Ni-Cr	5PK-S120NA-40H	250
8PK-S120NAD-60		60W	520°C ± 10%		5PK-S120NA-60H	280
8PK-S120NB-30	220- 240V	30W	440°C ± 10%		5PK-S120NB-30H	250
8PK-S120NB-40		40W	480°C ± 10%		5PK-S120NB-40H	
8PK-S120NB-60		60W	520°C ± 10%		5PK-S120NB-60H	280
8PK-S120NB-30		30W	440°C ± 10%		5PK-S120NB-30H	
8PK-S120NBD-40		40W	480°C ± 10%		5PK-S120NB-40H	250
8PK-S120NBD-60		60W	520°C ± 10%		5PK-S120NB-60H	

SI-129B-40/SI-129B-60**Soldering Iron****SI-129B-40**

- Working indicator.
- Ceramic insulating layer provide better protection.
- Long life soldering tip.
- PA66 handle.

**SI-129B-60****REPLACEABLE PARTS**

Soldering tip: SI-S120T series (P.79)

Heater: 5SI-129N-40H

5SI-129N-60H

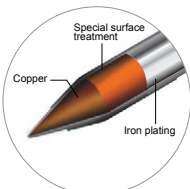

MODEL	Voltage	Consumption	Temp.	Heater	OAL (mm)
SI-129B-40	220- 240V	40W	450°C ± 10%	Ni-Cr	240
SI-129B-60		60W	500°C ± 10%		245

SI-126B-80/ SI-126B-100 Soldering Iron



NEW



SI-126B-80



SI-126B-100



Power Indicator

- PA+TPE handle.
- Working indicator.
- Stainless steel barrel.
- Long life soldering tip.
- Ceramic frame double-layer heater for long life.

REPLACEABLE PARTS

Soldering tip: 5SI-S126T series (P.79)
Heater: 5SI-126-80H/100H

MODEL	Voltage	Consumption	Temp.	Heater	OAL (mm)
SI-126B-80	220-240V 50Hz	80W	550°C ± 10%	Ni-Cr	255
SI-126B-100		100W	580°C ± 10%		270

8PK-S118 Series Soldering Iron



- Lead free.
- Seamless stainless pipe.
- Long life tip.
- Heat isolated tube.
- Wire protection tail cover.

REPLACEABLE PARTS

Soldering tip: SI-S120T series (p.79)

ACCESSORIES

Protection cap x1

MODEL	Voltage	Consumption	Temp.	Heater	OAL (mm)
8PK-S118A	110-120V	30W	400°C ± 10%	Ni-Cr	235
8PK-S118A-40		40W	440°C ± 10%		
8PK-S118B	220-240V	30W	400°C ± 10%	Ni-Cr	235
8PK-S118B-40		40W	440°C ± 10%		

SI-124B Series Soldering Iron



REPLACEABLE PARTS

Soldering tip: SI-S120T series (P.79)

MODEL	Voltage	Consumption	Temp.	Heater	OAL (mm)
SI-124B-40	230V	40W	420°C ± 10%	Ni-Cr	245
SI-124B-60		60W	450°C ± 10%		260
SI-124B-100		100W	500°C ± 10%		275

SI-B165 Cordless Soldering Iron**NEW**

- Touch induction heating with finger.
- LED indicator.
- Auto off.
- Type-C charging.

REPLACEABLE PARTS

Soldering tip: 5SI-B165-K
5SI-B165-T

ACCESSORIES

18650 Li-ion battery x1
Soldering iron holder x1
Type-C USB cord x1

Consumption	Temp.	Power source	Operation time	OAL (mm)
12W	500°C	3.7V 2200mAh	Approx. 1.5h	190

SI-B166 Wireless Power Soldering Iron

- 15sec. fast heating.
- Wireless charging.

REPLACEABLE PARTS

Soldering tip: 9SI-B166-T

ACCESSORIES

18650 Li-ion battery x1
Micro USB cord x1

Consumption	Temp.	Power source	Operation time	OAL (mm)
8W (max)	500°C	3.7V 2200mAh	Approx. 1.5h	190

SI-B162 Battery Operated Soldering Iron

- Work indicator.
- Comes with protection cap.
- Safety slide switch.

Auto power off
when cap attached

REPLACEABLE PARTS

Soldering tip: 9SI-B162-T

ACCESSORIES

Lead free solder wire: 9SI-B162-W
Cap x1

Consumption	Temp.	Power source	Operation time	OAL (mm)
8W (max)	Max. 450°C (with alkaline battery)	3x1.5V alkaline AA (not included)	185°C/365°F 15-20S (with alkaline battery)	178 (w/o cap)

SI-B161 Battery Operated Soldering Iron

- 30 min. continuous use.
- Work indicator.
- Come with protection cap.
- Long life tip.

REPLACEABLE PARTS

Soldering tip : 9SI-B161-T

Consumption	Temp.	Power source	Operation time	OAL (mm)
9W (max)	450°C (840°F)	1.5V alkaline AAx3 pcs (not included)	185°C / 365°F in 12S	190 (w/o cap)

SI-B20L Cordless Multi-Angle Soldering Iron



NEW

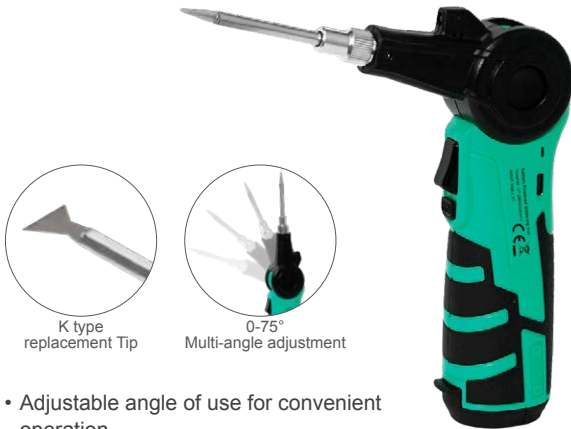

K type replacement Tip



0-75° Multi-angle adjustment

- Adjustable angle of use for convenient operation.

REPLACEABLE PARTS

Soldering tip: 5SI-B20L-T
5SI-B20L-K

ACCESSORIES

Round pointed soldering iron tip (5SI-B20L-T) x1
Shovel type heating tip (5SI-B20L-K) x1
18650 3.7V 2200mAh Li-ion battery x1
USB-C Charging cord x1
Soldering iron tip protect cover x1

Consumption	Temp.	Power source	Operation time
16W	500°C	3.7V 2200mAh 18650 Li-ion battery	45 mins

SI-132A/B Wood Burning Hobby Kit



SI-132A

SI-132B



- Nickel-chrome heating element.
- Heat shields x2 for better protection.

ACCESSORIES

Solder tip x1
Blade x1
Wood burning tips x8
Embossing tips x11

MODEL	Voltage	Consumption	Temp.
SS-132A	110-120V	25W	360°C
SS-132B	230-240V		

SI-168U/SI-169U USB Soldering Iron



SI-168U



SI-169U

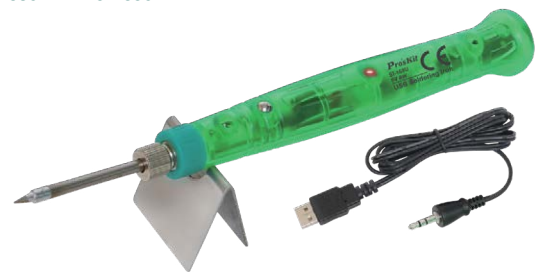

- Auto sleep mode.
- Working indicator.

REPLACEABLE PARTS

SI-169U soldering tip:
9SI-B162-T
9SI-169U series

SI-168U soldering tip:
9SI-B162-T

ACCESSORIES

SI-169U :
USB wire x1, Cap x1, Solder stand x1,
Solder wire x1, Tip x3

SI-168U :
USB wire x1, Cap x1, Solder stand x1,
Solder wire x1

MODEL	Consumption	Temp.	Power source	Size
SI-168U	8W	480°C ± 10%	USB input DC5V	Ø19 x 163mm
SI-169U				

SI-138A/B Wood Burning & Crystal Hotfix Kit



SI-138A



SI-138B



- Dual wattage.
- Nickel-chrome heating element.
- Heat shields x2 for better protection.

ACCESSORIES

Solder tip x1
Blade x1
Crystal hot fix tips x5
Wood burning tips x8
Embossing tips x11

MODEL	Voltage	Consumption	Temp.
SS-138A	110-120V 60Hz	10W / 30W	200°C / 400°C
SS-138B	230-240V 50Hz		

1PK-GS003 Portable Gas Soldering Tool Kit



- See-through fuel window.
- Adjustable flame control.
- Come with soldering tip and soldering head.

Soldering temperature	Hot blow temperature	Torch temperature	Fuel cap.	Time	Gas soldering size
210~400 °C	650 °C	1300 °C	8 ml	80 min	170×Ø 24 mm

8PK-101-2 Portable Soldering Tool Kit With Torch Tip



REPLACEABLE PARTS

Soldering tip : 5MT-T series

- See-through fuel window.
- Come with soldering tip and soldering head.

Soldering temperature	Hot blow temperature	Torch temperature	Fuel cap.	Time	Gas soldering size
370 °C	500 °C	1300 °C	6 ml	30~45 min	130×Ø 23 mm

GS-23K Gas Soldering Iron Kit-Auto Ignition



- Complies with CPSC.
- TR90 nylon gas tank.
- See-through fuel window.
- Ceramic heater.
- Adjustable flame control.

SPECIFICATIONS

Soldering temperature	500 °C
Hot blow temperature	600 °C
Torch temperature	1300 °C
Fuel cap.	15 ml
Time	90 min
Gas soldering size	245×Ø29 mm
Case size	300 x 138 x 46mm



Adjustable Flame Control

Come with soldering tip and soldering head.

SS-532B/SS-55 Series Solder Pot



SS-532B

CE
NEW



SS-55 Series

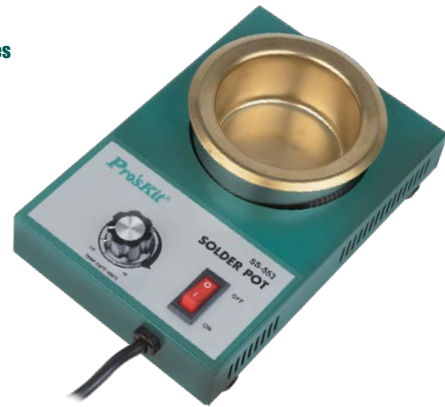

- Lead free.

MODEL	SS-532B	SS-551B	SS-552B	SS-553B	SS-554B
Voltage	220V-240V 50/60Hz				
Power consumption	200W	150W	200W	250W	300W
Temperature	100°C~550°C	100°C~600°C	100°C~550°C	100°C~450°C	100°C~450°C
Crucible size	Ø50x40Hmm	Ø38x35Hmm	Ø50x35Hmm	Ø80x40Hmm	Ø100x40Hmm
Crucible material	TA1 pure titanium	Stainless steel with titanium plating			
Melting time(Max.setting)	Approx.10mins	Approx.10mins	Approx.10mins	Approx.20mins	Approx. 20 mins
Dimension (LxWxH)	150x95x65mm	150x90x60mm	150x90x60mm	210x140x65mm	210x140x65mm
Solder capacity	600g	300g	500g	1.6kg	2.2kg

SS-562NB Digital Lead Free Solder Pot

CE



NEW



SS-571B Digital Preheat Platform

CE



MODEL	SS-562NB	SS-571B
Voltage	220V-240V 50/60Hz	
Power consumption	300W	300W
Temperature	Room temp. ~600°C	Room temp. ~400°C
Temperature accuracy	±5°C	
Control system	PID Control	PID Control
Temperature compensation setting	-200~400°C	-200~400°C
Crucible size	Φ50×40 (mm)	100×100×15 (mm)
Crucible material	Titanium	Aluminum alloy
Melting time (temp. 280°C)	Approx. 8 mins	Approx. 10 mins
Dimension (LxWxH)	280×145×115 (mm)	280×145×115 (mm)
Solder capacity	600g	-

Hot Air Guns

SS-626B
Heat Gun With LCD Display
CE
NEW

Digital display

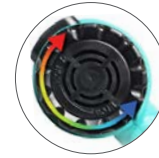

Temperature adjustment knob



Concentrate nozzle

REPLACEABLE PARTS

Heater: 5SS-626H-H

- LCD display.
- Overheat protection.
- Drop protection.

Voltage	Power	Air volume	Temperature
220-240V 50 Hz	1800W	I: 200L/min II: 350L/min	I: 50-350°C II: 50-600°C

SS-615B
Adjustable Temperature Heat Gun
CE
NEW

Temperature adjustment knob



Concentrate nozzle

REPLACEABLE PARTS

Heater: 5SS-626H-H

- Overheat protection.
- Smart protection design.
- Stepless temperature adjustment.

Voltage	Power	Air volume	Temperature
220-240V 50/60 Hz	I: 210~300W II: 210~1800W	I: 200L/min II: 350L/min	I: 100-400°C II: 100-550°C

SS-611A/B Heat Gun Set



SS-611A



SS-611B



- Overheat protection.
- Dual air volume.
- Ceramic heater.
- Double insulated.



Storage box



REPLACEABLE PARTS

Heater: 9SS-611A-H, 9SS-611B-H

ACCESSORIES

Hook nozzle x1
Slit nozzle x1
Deflector nozzle x1
Air concentration nozzle x1
Scraping tool x1

MODEL	Voltage	Consumption	Air volume	Temperature	Case size
SS-611A	110-120V 60Hz	I: 750W II: 1500W	I: 280L/min II: 480L/min	I: 300°C II: 500°C	300 x 280 x 90mm
SS-611B	230-240V 50Hz				

SS-602B/E Hot Air SMD Rework Tool



SS-602B



SS-602E



- Portable.
- °C/°F selection.
- Anti- return air protection.
- Can be used for DIP/QFP/SOP/PLCC.



REPLACEABLE PARTS

Nozzle: 9SS-602-A1
9SS-602-A2
9SS-602-A3
Heater: 9SS-602B-H, 9SS-602E-H

ACCESSORIES

Nozzle x3

MODEL	Voltage	Consumption	Air volume	Temperature	Standard nozzle
SS-602B	220-240V	300W	For 3 ranges, max. 22L/min(Max)	200°C-500°C	Ø5mm Ø8mm Ø12mm
SS-602E	110-120V				

SS-628A/F Mini Hot Air Gun



NEW



SS-628A



SS-628F



- Two levels of temperature adjustment.
- Heats up quickly.
- Efficient heat collection.
- Lightweight and portable.



Reflector bayonet nozzle

REPLACEABLE PARTS

Heater: 5SS-628A-H, 5SS-628F-H

ACCESSORIES

Reflector bayonet nozzle x1

MODEL	Voltage	Consumption	Air volume	Temperature
SS-628A	110-120V 50/60 Hz	250W/500W	I: 150L/min II: 300L/min	I: 350°C II: 500°C
SS-628F	230/240V 50/60 Hz			

**GK-389B Professional Hot Melt
Glue Gun****100W**

- Ideal for production line.
- PTC heating system.
- Non-Drip.
- Large flow amount.
- Quick warm up.

Voltage	Power	Preheat time	Temp.	Flow of glue	Glue stick size
110-240V	100W	2-5min	170°C (200°C)	15-25g/min	Ø11mm

**GK-390B Professional Hot Melt
Glue Gun****80W**

- Ideal for DIY.
- PTC heating system.

Voltage	Power	Preheat time	Temp.	Flow of glue	Glue stick size
110-240V	80W	3-6min	150°C	15-20g/min	Ø11mm

**PTC heating system****GK-360A/F Glue Gun****GK-360A****GK-360F****20W**

- 3 Mins fast heat.
- Drip-proof.
- Eco-friendly.
- PTC heating system.

Voltage	Power	Preheat time	Temp.	Flow of glue	Glue stick size
110-240V	20W	3-5min	170°C	3-5g/min	Ø7-Ø7.5mm

GK-366U

USB Cordless Glue Gun



NEW



- 40 sec fast heat up.
- Stable standing base.
- 4 colors glitter hot glue sticks.



40 sec fast heat up



360° anti-scald sheath

ACCESSORIES

- USB charging cord
- Ø 7.0x140mm glue stick x12
- Ø 7.0x140mm colored glue stick x 8

Power	Temp.	Power source	Running time	Flow of glue	Glue stick size
5-15W	170±10°C	Li-ion 3.7V 2000mAh	1h	2g/min	Ø7mm

GK-361U

3.6V Li-ion USB Glue Gun



8W

ACCESSORIES

- USB charging cord

Power	Temp.	Power source	Running time	Flow of glue	Glue stick size
8W	130°C	3.6V 2000mAh Li-ion	1.5h	3g/min	Ø7mm

GK-368

Battery Operated Glue Gun



7W

- Cordless design.
- LED light.
- Quick warm up.

ACCESSORIES

- Ø 7.5x100mm glue stick x3

Power	Temp.	Power source	Running time	Flow of glue	Glue stick size
7W	-	1.5V AA battery x4 (not included)	45 minutes (Alkaline type)	3g /min	Ø7.5mm

61103/GK-611160/GK-607160

Glue Stick



61103



GK-611160



GK-607160

- Lead free.

MODEL	61103	GK-611160	GK-607160
Glue stick size (mm)	Ø11	Ø11	Ø7
OAL (mm)	300	160	160
Quantity	33pcs /1bag	10pcs /1bag	10pcs /1bag



* For packing info please refer to the index at the back.

Desoldering

8PK-366N Series Desoldering Pump



8PK-366NA

- ESD Safe.



8PK-366N-B



8PK-366N-G



8PK-366N-O



8PK-366N-S



8PK-366N-Y



MODEL	8PK-366NA	8PK-366N-B	8PK-366N-G	8PK-366N-O	8PK-366N-S	8PK-366N-Y
Material	ABS					
Suction capacity	30cm-Hg				35cm-Hg	30cm-Hg
Replacement Parts	5PK-366NA-T			5PK-366N-T		
OAL (mm)	205					

DP-366C/DP-366D/DP-366I/DP-366J/8PK-366D/908-366A Desoldering Pump



DP-366C



DP-366D

- Lead free.



DP-366I

- ESD Safe.



DP-366J



8PK-366D

- ESD Safe.



908-366A

- ESD Safe.



MODEL	DP-366C	DP-366D	DP-366I	DP-366J	8PK-366D	908-366A
Material	ABS	ABS	Aluminum	PC	Aluminum	Aluminum
Suction capacity	34cm-Hg	32cm-Hg	30cm-Hg	32cm-Hg	30cm-Hg	32cm-Hg
Replacement Parts	508-366C-T	5DP-366D-T	5DP-366I-T	5DP-366J-T	508-366D-T	508-366A-T
OAL (mm)	195	210	162	210	163	195

DP-366P Desoldering Pump



- Lead free
- High suction
- Changeable tip.

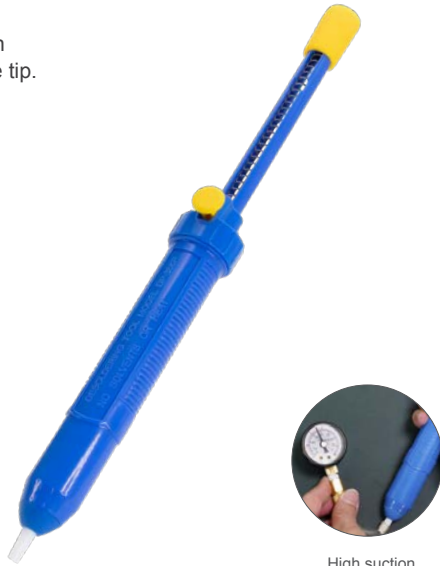

High suction

Material	Suction capacity	Replacement Parts	OAL (mm)
ABS	40cm-Hg	5PK-366PN-T	330

DP-366A Desoldering Pump



NEW



- ESD safe.
- Lead free.



High suction

Material	Suction capacity	Replacement Parts	OAL (mm)
PP	38cm-Hg	5DP-366A-T	333

DP-033 Series Anti-Hot Desoldering Wick



- Anti-scald design.
- Stainless steel mouth.
- High quality desoldering braid with unique no clean flux.

MODEL	Width (mm)	Length (m)	Dimension
DP-033A	1.5	2	101 x 47.5 x 18.5 mm
DP-033B	2.0	2	
DP-033C	2.5	2	
DP-033D	3.0	1.5	
DP-033E	3.5	1.5	

8PK-031 Series Desoldering Wick



- High quality desoldering braid with unique no clean flux.
- Pure oxygen-free copper wire.

MODEL	Width (mm)	Length (m)
8PK-031A	1.5	1.5
8PK-031B	2.0	1.5
8PK-031C	2.5	1.5

SN-396N**Soldering Helping Hand with LED Magnifier****NEW**

- 7 in 1 multifunctional.
- Crystal glass lens.
- 4 universal arms.
- With alligator clip.

ACCESSORIES

Sponge size: 30 x 50mm
Solder flux : 10g
Brass tip cleaner : 17g
Type-C charging cable

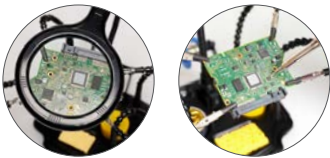
**SPECIFICATIONS**

Power	DC 5V 1A (USB)
Magnifying lens size	Ø100mm & Ø24mm
Magnification	1.75X(3D) + 4X(12D)
Magnification material	Glass
Light source	40 pcs SMD LEDs
Neck length(for magnifier)	270mm
Neck length(for alligator clips)	270mm
Base size	190x170mm
Weight	1kg

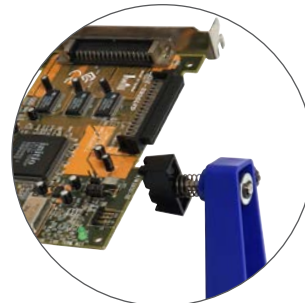
SN-390**Adjustable Soldering Clamp Holder**

360 degrees
rotation

- Rigid metal structure.
- Rubber pad.
- 2 adjustable ABS grip.
- 4 different thicknesses.
- Lightweight design.



4 different
thickness holders

SPECIFICATIONS

Material	ABS arm + metal base
Max. circuit board size	20 x 14 cm
Circuit board thick	1.2 / 1.8 / 2.0 / 3.0mm
Dimensions	30 x 16.5 x 12.5 cm

SN-394 **Helping Hand Octopus Clamp Kit** 

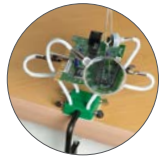

- Maximum thickness of table or bench edge: 1.5"(40mm).
- Including magnifier arm x1, magnet arm x1, stayput arms x4.

Lens material	Magnification	Lens size
Acrylic	2.5X	Ø 40mm

SN-392 **Helping Hands**



- Lead free.

Lens material	Magnification	Lens size
Acrylic	2.5X & 4.5X	Ø 90mm

608-391A **Helping Hands** 



Lens material	Magnification	Lens size
Glass	3X (8D)	Ø 60mm

608-391E **Helping Hands** 



Lens material	Magnification	Lens size
Glass	3X (8D)	Ø 60mm

608-391B **Helping Hands** 



Base OAL(mm)
52x52x55

SH-1025 **Soldering Tip Cleaner**



- Lead free.
- Made of low abrasive brass shavings.

Material	Size	Replacement
Copper/Iron	Ø 83 x 27mm	SH-1025-B

6S-2/SN-002 Soldering Stand



6S-2



SN-002



MODEL	6S-2	SN-002
Base size	85x130x23mm	85x130x22mm

1PK-3616 Soldering Aid Tools



8PK-033ST Solder Reel Stand



(Solder is not included)

Shaft diameter	15mm	Dimensions	98x88x75mm
----------------	------	------------	------------

DP-3616 Soldering Aid Tools

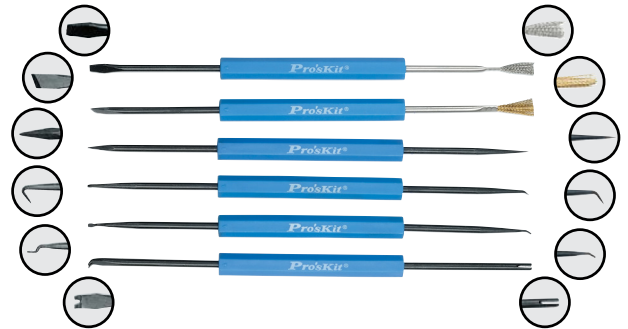

8PK-362S Mini Soldering Stand



- Lead free.
- 2 position iron holder stand.
- Built-in sponge tray.

Base size	47x40x12mm
-----------	------------

**1PK-H074/9H084
9H085/9H086 Soldering Aid Tools**



Model No.	1PK-H074	9H084	9H085	9H086
Material	Nylon+Fiber			
OAL (mm)	150	155	140	173

9DP-S002/9S001 9S002/9SN-310G Solder Wire



9DP-S002



9S001



9S002



9SN-310G



RoHS
COMPLIANT
9DP-S002



RoHS
COMPLIANT
9SN-310G



9S002



9S001

MODEL	9DP-S002	9SN-310G	9S002	9S001
Ingredients	Sn 99.3% , Cu0.7%	Sn 99.3% , Cu0.7%	2% Ag	63% Sn
Dia (mm)	1.0	1.0	0.8	1.0
Weight(g)	17	15	15	17

8S005 Solder Paste



- Composed of metal powder activated flux and blending agents.
- The paste has a good diffusion and non-corrosion.
- No spot appears in non-soldered area.

Weight	Size
50g	Ø 66x17mm

8PK-033 Series Solder



- Use 63% tin and 37% lead as synthetic raw materials.
- The proportions of tin-lead alloys are up to the proportion standard, and the welding effect is good.

MODEL	Material	Weight (g.)	Ø (mm.)
8PK-033D	100	63% Sn	0.8
8PK-033DD	100	2% Ag	0.8
8PK-033DDS	100	2% Ag	0.6
8PK-033DS	100	63% Sn	0.6
8PK-033E	100	63% Sn	1
8PK-033F	100	63% Sn	1.2
8PK-033J	250	63% Sn	0.8
8PK-033JS	250	63% Sn	0.6
8PK-033K	250	63% Sn	1
8PK-033L	250	63% Sn	1.2
8PK-033P	500	63% Sn	0.8
8PK-033Q	500	63% Sn	1
8PK-033R	500	63% Sn	1.2

* For packing info please refer to the index at the back.

Accessories / Replacement Tips

unit : mm

SSI-125T Series



SSI-125T-B



SSI-125T-D



SSI-125T-SB

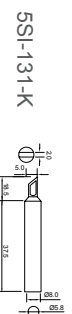

SSI-131-K



SSI-139-2D



SSI-139-3C

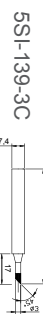

SSI-139-B

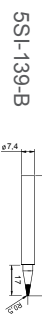

SSI-139-SB

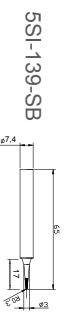

SSI-216N-0.8D



SSI-216N-1.2D



SSI-216N-1.6D



SSI-216N-1C



SSI-216N-2C



SSI-216N-3.2D



SSI-216N-3C



SSI-216N-4C



SSI-216N-B



SSI-216N-B1.0



SSI-216N-BC



SSI-216N-I



SSI-216N-K



SSI-259-B



SSI-259-C

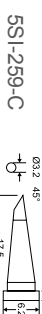

SSI-259-D



SSI-259-I



SSI-259-K

9SSc116N Series

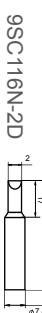

9SS-900-A2



9SS-900-A3



9SS-900-B

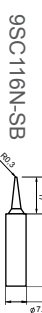

9SS-900-C



9SS-900-E



9SS-900-H



9SS-900-L

SI-S120T-4 Series



SI-S120T-4B



SI-S120T-4C

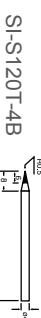

SI-S120T-4SB



SI-S120T-5B



SI-S120T-5SB

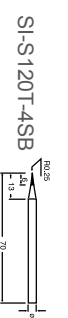

SI-S120T-6B



SI-S120T-6BC

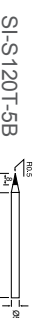

SI-S120T-6C

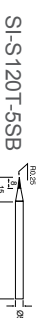

SI-S120T-6SB



SI-S120T-6SB

SSI-131 Series

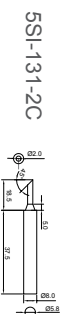

SSI-131-2C



SSI-131-3C



SSI-131-B



SSI-126T-8D



SSI-126T-7B



SSI-126T-7D

SSI-126T-8 Series (08)



SSI-126T-8B



SSI-126T-8D

SSI-216N Series



SSI-216N-0.8D



SSI-216N-1.2D



SSI-216N-1.6D



SSI-216N-1C



SSI-216N-2C



SSI-216N-3.2D

SSI-259 Series



SSI-259-B

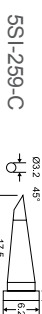

SSI-259-C

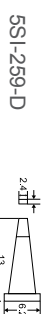

SSI-259-D



SSI-259-I



SSI-259-K



9SS-900-O



SI-S120T-4B

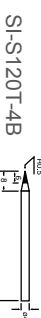

SI-S120T-4C



SI-S120T-4SB



SI-S120T-5B

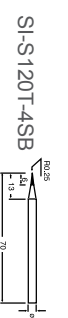

SI-S120T-5SB



SI-S120T-6B

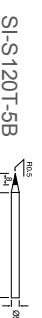

SI-S120T-6BC



SI-S120T-6C



SI-S120T-6SB

SI-S120T-6 Series

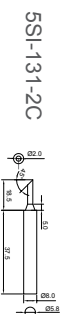

SI-S120T-6B

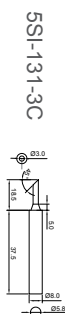

SI-S120T-6C



SI-S120T-6SB

FIBER OPTICS



FIBER OPTIC FUSION SPLICER

The fiber optic fusion splicing machine is a specialized device designed to precisely fuse two fiber optic cables, creating a continuous optical connection. In high-speed communication systems, it ensures seamless connectivity between fiber optics, providing high-quality signal transmission. With the growing demands of AI computing and communication, the need for fiber optic fusion splicing machine has surged, providing a reliable foundation for high-speed, high-bandwidth data transmission.





ACCESSORIES

Machine x 1, AC adaptor x 1, Battery x 1,
Spare electrodes x 1, Protection sleeve x 25,
Cooling tray x 1, Carrying belt x 1,
Carrying case x 1, Disk x1

SPECIFICATIONS

Applicable fiber	SM, MM, NZDS, EDF
Average splice loss	0.015dB(SM), 0.01dB(MM), 0.04dB(NZDS), 0.04dB(ED)
Splice time (Sec.)	9s (for SM fiber)
Suitable for cutting optical fiber length	10-16mm
Suitable for optical fiber core	Cladding diameter:80-150µm, Coating diameter:100-1000µm
Return loss	≥60dB
Fiber image magnification	Separately X or Y views with 520 times or 260 times for X and Y view together
Working motor	6 motors
Fiber alignment	core to core
Fiber recognition	G651/G652(654)/G655
Tension test	2.0N(200gf)(standard)
Splice program	50 groups
Electrode life	5000 times
Protection sleeve length	20-60mm
Storage of splice result	6000 groups of splice results
Storage of splice image	100 groups of splice images
Monitor	4.3 "high resolution colorful LCD
Communication port	Micro USB
Working light	1 LED light
Power indication	5 led light indication
Environment conditions	-10~+50°C (working temperature), 0~95% RH(humidity), 0~5000m(altitude)
Power supply	Lithium battery: 10.95V/5.2A Adapter: INPUT AC 100~240V 50/60Hz; OUTPUT: DC15V/5A
Dimension	149x135x135mm
Weight	1.75Kgs (include battery) , 1.4Kgs(not include battery)

- TOOL KITS
- TEST INSTRUMENTS
- SOLDERING & DESOLDERING
- FIBER OPTICS**
- GRIPPERS
- PRECISION PLIERS & CUTTERS
- ELECTRICAL PLIERS & CUTTER
- STRIPPERS
- PUNCH DOWN TOOLS
- ALIGNMENT TOOL & SCREWDRIVERS
- HEX KEY WRENCHES

TE-8202A/F · TE-8202A-W/F-W**Fiber Optic Fusion Splicing Machine Kit****TE-8202A-W****TE-8202F-W****TE-8202A****TE-8202F****TE-8202A-W/F-W ACCESSORIES**

Machine x1, AC adaptor x1,
Battery x1, Spare electrodes x1,
Protection sleeve x 25,
Cooling tray x 1, USB cable x 1,
Carrying belt x 1, Carrying case x 1, Disk x 1

TE-8202A/F ACCESSORIES

Machine x1, Fiber cleaver x 1,
Fiber stripper x 1, Liquid dispenser bottle x1,
AC adaptor x1, Battery x1, Spare electrodes x1,
Protection sleeve x 25, Cooling tray x 1,
USB cable x 1, Carrying belt x 1,
Carrying case x 1, Disk x 1

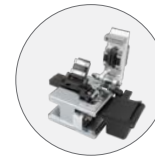
8PK-326
(TE-8202A/F ONLY)FB-1618C
(TE-8202A/F ONLY)MS-018
(TE-8202A/F ONLY)

SPECIFICATIONS	TE-8202A/TE-8202A-W	TE-8202F/TE-8202F-W
Applicable fiber	SM, MM, NZDS, EDF	
Average splice loss	0.02dB(SM), 0.01dB(MM), 0.04dB(NZDS), 0.04dB(EDF)	
Splice time (sec.)	10 sec. (for SM fiber)	
Return loss	≥60dB	
Diameter of fiber optic	Cladding diameter:80-150μm , Coating diameter:100-1000μm	
Magnification	500 times for single X or Y view; 250 times for X and Y view	
Tension test	2.0N(200gf)(Standard)	
Splicing program	50 groups	
Protection sleeve length	20-60mm	
Electrode life	6000 times	
Memory capacity	10000 memories	
Monitor	5" colorful LCD display	
Communicating port	Micro USB	
Environmental conditions	-10~+50°C (working temperature), 0~95% RH(humidity), 0~5000m(altitude)	
Power adapter	INPUT AC 100~240V 50/60Hz; OUTPUT: DC15V / 5A	
Battery	10.95V / 6A	
Voltage	AC110-120V	AC220-240V
Dimension	155 x 145 x 145 mm	
Weight	1.98kg (include battery) / 1.6kg (not include battery)	

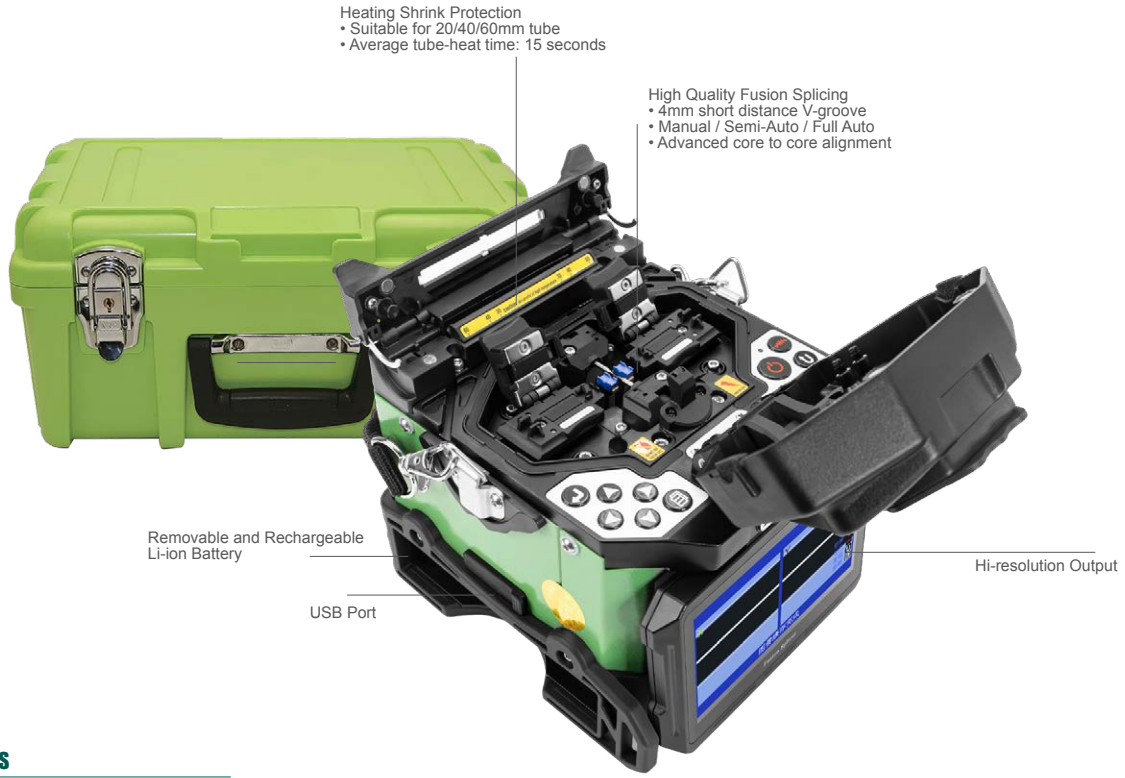

ACCESSORIES

Machine x 1, AC adaptor x 1, Battery x 1, Spare electrodes x 1, Protection sleeve x 25, Cooling tray x 1, Carrying belt x 1, Carrying case x 1, Disk x 1

SPECIFICATIONS

Applicable fiber	SM, MM, NZDS, EDF
Average splice loss	0.02dB(SM), 0.01dB(MM), 0.04dB(NZDS), 0.04dB(EDF)
Splice time (sec.)	6 sec. (for SM fiber)
Return loss	≥60dB
Diameter of fiber optic	Cladding diameter:80-150μm, Coating diameter:100-1000μm
Magnification	520 times for single X or Y view; 200 times for X and Y view
Tension test	2.0N(200gf)(Standard)
Splicing program	50 groups
Protection sleeve length	20-60mm
Electrode life	5000 times
Memory capacity	6000 memories
Monitor	4.3" colorful LCD display
Communicating port	Micro USB
Environmental conditions	-10~+50°C (working temperature), 0~95% RH(humidity), 0~5000m(altitude)
Power adapter	INPUT AC 100~240V 50/60Hz; OUTPUT: DC15V/5A
Battery	11.1V / 5.2A
Voltage	AC220-240V
Dimension	145 x 135 x 142mm
Weight	1.7ks(with battery), 1.35kg(not included battery)



MT-7620**Mini Touch-screen Optical Time Domain Reflectometer****NEW**

- Optical multimeter: OPM, VFL, OLS three-in-one function.

ACCESSORIES

Charging cable (Type-C) x1,
CD x1, Lanyard x1,
Cleaning stick x1, Carrying bag x1

SPECIFICATIONS

Dynamic range	20dB
Test range	0.1~80km
Wavelength	1550nm±20mm
Connector	SC/UPC (same as OLS connector)
Pulse width	5ns~20us
Measurement time	5~180s
Attenuation blind area	Attenuation 12m / Event 3m
Measurement mode	Real time, average, automatic
Sampling point	up to 8000
Input light detection	Support < 10dB **
OPM display range	-50~+26dBm
OPM calibrated wavelength	850, 980, 1270, 1300, 1310, 1490, 1550, 1577, 1625, 1650nm
VFL power	10mW
VFL wavelength	650nm±20nm
VFL optical fiber connector	2.5nm universal connector
OLS power	>-5dBm *
OLS wavelength	1550nm±20mm
OLS modulation	270Hz, 1kHz, 2kHz, 1kHz+flicker, 2kHz+flicker
Monitor	3.5 inch touch screen
Charging port	Type-C
Storage(SOR)	>500
Battery	3.7V-2000mA Lithium battery
Working time	Standby > 6h ; Measuring > 4h
Environmental conditions	Working: 0-50°C; Storage:-20-70°C; Humidity: <90%
Dimension	112x76x38mm
Weight	220g

MT-7650**Multifunctional Touch-screen Optical Time Domain Reflectometer****NEW****ACCESSORIES**

Charging cable (Type-C) x1, CD x1,
Lanyard x1, Cleaning stick x1,
Carrying bag x1

SPECIFICATIONS

Dynamic range	20dB
Test range	0.1~80km
Wavelength	1550nm±20mm
Connector	SC/UPC (same as OLS connector)
Pulse width	5ns~20us
Measurement time	5~180s
Attenuation blind area	12m
Event blind area	3m
Measurement mode	Real time, average, automatic
Sampling point	up to 8000
Input light detection	Support < 10dB **
OPM display range	-50~+26dBm
OPM calibrated wavelength	850, 980, 1270, 1300, 1310, 1490, 1550, 1577, 1625, 1650nm
VFL power	10mW
VFL wavelength	650nm±20nm
VFL optical fiber connector	2.5nm universal connector
OLS power	>-5dBm *
OLS wavelength	1550nm±20mm
OLS modulation	270Hz, 1kHz, 2kHz, 1kHz+flicker, 2kHz+flicker
Monitor	3.5 inch touch screen
Charging port	Type-C
Storage(SOR)	>500
Language	EN/TW/CN
Battery	3.7V-2000mA Lithium battery
Working time	Standby > 6h ; Measuring > 4h
Environmental conditions	Working: -10-50°C; Storage:-20-70°C; Humidity: <90%
Dimension	112x76x38mm
Weight	220g

MT-7610A/F Optical Time Domain Reflectometer



MT-7610A



MT-7610F



ACCESSORIES

Host x1, Power adapter x1,
Power cable x1, USB cable x1,
Carrying bag x1

- One button test - Complete event map.
- Accurate - Measurement up to 100km.
- wavelength support - 1310nm/1550nm.

SPECIFICATIONS	MT-7610A	MT-7610F
Applicable fiber	SM	
Dynamic range	24dB(1310nm) / 22dB(1550nm)	
Test range (km)	0.1~100	
Distance uncertainty (m)	$\pm(0.8+0.005\% \times \text{distance} + \text{Sampling resolution})$	
Wavelength	1310nm \pm 20nm, 1550nm \pm 20nm	
Connector	SC/PC (FC/PC, ST/PC Optional)	
Pulse width	5ns~10us	
Measurement time	5s~180s	
Attenuation blind area	8m	
Event blind area	3m	
Loss threshold (db)	0.01dB	
Loss resolution (db)	0.01dB	
Sampling resolution (m)	0.32 to 20.48	
Sampling point	Up to 8000	
VFL power	1mW	
VFL wavelength	650nm \pm 20nm	
Monitor	3.5 inch color LCD	
Communication connector	micro USB	
Storage	32MB Built-in storage	
Language	EN/TW/CN	
Battery	7.4V 3100mA Lithium battery	
Working time	Standby > 15hours ; Measuring > 8 hours	
Environmental conditions	Working: 0-50°C; Storage:-20-70°C; Humidity: <90%	
Power supply	Adapter: Input AC 100~240 50/60Hz; Output DC 12V/2.0A	
Voltage	AC110-120V	AC220-240V
Dimension	195x110x60mm	
Weight	600g	

MT-7612A/F Multi-function Optical Time Domain Reflectometer



MT-7612A



MT-7612F



ACCESSORIES

Host x1, battery x1, Power adapter x1,
Power cable x1, USB cable x1,
Carrying bag x1

- 3 in 1.
- Optical time domain reflectometer.
- Power meter.
- Visual fault locator.

SPECIFICATIONS	MT-7612A	MT-7612F
Dynamic range	20dB	
Test range (km)	0.1~80km	
Distance uncertainty (m)	$\pm(0.8+0.005\% \times \text{distance} + \text{Sampling resolution})$	
Wavelength	1550 \pm 20nm	
Connector	SC/PC (FC/PC, ST/PC Optional)	
Pulse width	5ns~20 μ s	
Measurement time	5~180s Adjustable	
Attenuation blind area	8m	
Event blind area	3m	
Loss threshold (db)	0.01dB	
Loss resolution (db)	0.01dB	
VFL power	1mW	
VFL wavelength	650 \pm 20nm	
OPM detect range	-50~+26dBm	
OPM detect wavelength	700~1700nm	
OPM calibration wavelength	850 / 980 / 1270/ 1300 / 1310 / 1490 / 1550 / 1577/ 1625 / 1650nm	
OPM optical connector	ST/SC/FC & 2.5mm Universal	
OPM accuracy	\pm 0.2dB	
OPM resolution	0.01dB	
Monitor	3.2 Inch color LCD	
Storage	Internal storage 500 records.Maximum 32GTF Card	
Battery	3.7V/2.4A Lithium Battery	
Working time	Standby >7.5H ; Measuring >4H	
Environmental conditions	Working: 0-50°C; Storage:-20-70°C; Humidity: <90%	
Power supply	Adapter: Input AC 100~240 50/60Hz; Output DC 5V 0.5A	
Voltage	AC110-120V	AC220-240V
Dimension	168 x 82 x 40mm	
Weight	260g	

* For packing info please refer to the index at the back.

MT-7602 4 in 1 Fiber Optic
Power Multimeter

- 4 IN 1 : Fiber power meter, visual fault locator, cable Tester, LED flashlight.
- Battery indication.
- Auto power off.
- USB external power supply.

ACCESSORIES

LC adapter (5MT-7601-LC)
(NOT INCLUDED)
SC adapter (5MT-7601-SC)
(NOT INCLUDED)
Machine x 1
Remote unit x1

SPECIFICATIONS

Cable test range	600m
Detector type	InGaAs
Measurement range	+10 ~ -70 dBm
OPM connector	ST/SC/FC & 2.5mm Universal
Measurement wavelength	850/1300/1310/1490/1550/1625 nm
Accuracy	(1550nm, 1310nm) \pm 0.2dB/(1490nm, 1625nm) \pm 0.3dB/ (850nm, 1300nm) \pm 0.4dB
Power measurement linearity	\pm 2%
Display resolution	+10~-60dBm(0.01dB)/-60~-70dm(0.1dB)
Units	dBm, μ W, mW
VFL power	<1mW
VFL wavelength	650nm \pm 20nm
VFL test range (km)	3~5km @SM
Laser safety rating	Class 2
Output modes	Continuous (CW), 2 Hz pulsed
Auto power off	10 min.(Can be cancelled)
Low battery indication	Low battery indication
Battery	1.5V AA x 2 (Not included)
Working time	> 100hours (OPM)
Dimension	125x52x34 mm
Weight	90g(battery not included)

MT-7625 Optical Power Meter
& Tone Probe Kits**NEW**

- All in 1 OPM & tone probe.
- Power meter 10 wavelengths.
- Visual fault locator.
- Dual mode cable mapping.
- Single-way plug crimping quality test.
- 1 on 2 lan cable testing.

ACCESSORIES

Type-C Charging Cable x1. Headset x1.
RJ45 Patch-cord x1. Alligator Clip Patch-
cord x1. Bag x1

TRANSMITTER SPECIFICATIONS

Cable tracing signal	Analog / Digital
Cable tracing frequency	455kHz
Cable tracing range	600m
Applicable network	UTP/STP Network cable
Network line test range (km)	600m
Detector type	InGaAs
Wavelength range	700-1700nm
Measurement range	-70-10dBm
OPM connector	2.5mm universal connector
Measurement wavelength	850, 980, 1270, 1300, 1310, 1490, 1550, 1577, 1625, 1650nm
Accuracy	(1550, 1310nm) \pm 0.2dB (850nm, 980n- m, 1300nm, 1490nm, 1625nm, 1650nm) \pm 0.3dB (1270nm, 1577nm) \pm 1dB
Units	dB, dBm, mW, μ W, nW
Data storage	500 groups
Modulation detection	270/330/1k/2kHz
VFL power	15mW
VFL wavelength	650nm \pm 20nm
VFL test range (km)	10-12km @SM
Crimping test	Connector RJ45 8pin; >10cm
Battery	3.7V 450mAh Li-ion / type C charging
Working time	> 30hours (OPM)
Environmental conditions	Working: -10-50°C ; Humidity: <90%
Dimension	114x65x29mm
Weight	120g

RECEIVER SPECIFICATIONS

Receiver signal	Analog / Digital
Response frequency	455kHz
Battery	3.7V 450mAh Li-ion / type C charging
Dimension	180x45x26 mm
Weight	100g

MT-7615/ MT-7616 4 in 1 Fiber Optical Power Multimeter



MT-7615



MT-7616

- Power meter.
- LAN cable tester.
- Visual fault locator.
- LED flash light.



ACCESSORIES

- USB charging cable
- Hand carrying rope

MODEL	MT-7615	MT-7616
Detector type	InGaAs	
Wavelength range	700-1700nm	
OPM connector	2.5mm Universal	
Measuring wavelength	850/980/1270/1300/1310/1490/1550/1577/1625/1650nm	
Measuring range	-70~+10dBm	-50~+30dBm
Accuracy	±0.2dB(1310/1550nm) ±0.3dB(850/980/1300/1490/1625/1650nm) ±1dB(1270/1577nm)	
VFL output power	15mW	30mW
VFL test length	10-12km @Single Mode	14-16km @Single Mode
VFL connector	2.5mm Universal	
VFL wavelength	650±20nm	
VFL laser mode	Continuous / Flashing	
LAN cable	UTP Cable	
LAN Cable connector	RJ45(UTP / 8P8C)	
Cable mapping	Yes	
Measuring length	600m	
Working hours	>50hrs (Power Meter Only)	
Battery	3.7V 450mAh, Li-ion / Micro USB charging	
Working environment	-10~50°C, <90%RH	
Dimension	98 x 59 x 27mm	
Weight	100g	

MT-7617/ MT-7618 Mini Palm Fiber Optical Power Multimeter



MT-7617



MT-7618

- Power meter.
- LED flash light.
- Visual fault locator.
(MT-7618 Only)



ACCESSORIES

- Hand carrying rope

MODEL	MT-7617	MT-7618
Detector type	InGaAs	
Wavelength range	700-1700nm	
OPM connector	2.5mm Universal	
Measuring wavelength	850/980/1270/1300/1310/1490/1550/1577/1625/1650nm	
Measuring range	-70~+10dBm	-50~+30dBm
Resolution	0.01dB	
Accuracy	±0.2dB(1310/1550nm) ±0.3dB(850/980/1300/1490/1625/1650nm) ±1dB(1270/1577nm)	
Power display units	dB, dBm, mW, uW, nW	
Modulation detection	270/1k/2kHz	
Data storage	500	
Wavelength ID	Yes (only applicable for Pro'sKit products)	
Output power	-	1mW
VFL test distance	-	3-5 km single mode
VFL connector	-	2.5mm Universal
VFL wavelength	-	650 ± 20 nm
VFL laser mode	-	Continuous / Flashing
Assistive light	LED	
Auto power off	Y (10 mins)	
Low battery indication	Yes	
Charging port	Micro USB	
Working hours	AAA battery > 100 hrs (power meter)	
Battery	1.5V AAA x 2	
Working environment	-10~50°C, <90%RH	
Dimension	98 x 59 x 27 mm	
Weight	70g (battery not included)	

MT-7901 Optical Fiber Identifier



Hood

- One press signal identification.
- Macrobend detection.
- 4 in 1 universal module.

ACCESSORIES

- Portable package x1
- Hood x1



Buzzer indication

SPECIFICATIONS	
Min. detectable power	250µm @1550nm=-30dBm / 250µm @1310nm=-25dBm 900µm @1550nm=-30dBm / 900µm @1310nm=-25dBm 2mm @1550nm=-30dBm / 2mm @1310nm=-25dBm 3mm @1550nm=-25dBm / 3mm @1310nm=-20dBm
Max. input	+5dBm
Wavelength	800nm~1700nm
Frequency identify	270Hz/1KHz/2KHz
Fiber type	250µm,900µm,2mm,3mm with SM Fiber
Clamp loss	<2.5dB
Operation temperature	Working: 0~50°C ; Storage: -20~+70°C ; Humidity:<90%
Battery	1.5V AA x2
Dimension	43 x 47 x 230mm
Weight	200g (battery not included)

TOOL KITS
TEST INSTRUMENTS
SOLDERING & DESOLDERING
FIBER OPTICS
GRIPPERS
PRECISION PLIERS & CUTTERS
ELECTRICAL PLIERS & CUTTER
STRIPPERS
PUNCH DOWN TOOLS
ALIGNMENT TOOL & SCREWDRIVERS
HEX KEY WRENCHES

MT-7603 Fiber Optical Power Meter



- Visual fault locator.
- PC link system.
- 1000 data memories.

ACCESSORIES

Soft bag x1
LC adapter (5MT-7601-LC)
(NOT INCLUDED)
SC adapter (5MT-7601-SC)
(NOT INCLUDED)

SPECIFICATIONS

Detector type	InGaAs
Optical connector	FC / ST / SC & 2.5mm universal
Measurement range	+8~ -70dBm
Measurement wavelength	850,1300,1310,1490,1550,1625nm
Resolution	0.01dB
Accuracy	±0.2dB
Measurement linearity	±2.0%
Display resolution	+8~ -60dBm: 0.01dB, -60~ -70dBm: 0.1dB
Power display units	dBm, mW, uW, nW,
Communication connector	USB
Data storage	1000 groups
Modulation detection	270Hz,1kHz, 2kHz
VFL power	1mW
Auto power off	10 min (can be cancelled)
Low battery indication	Yes
Working time	> 160 hours
Environmental condition	Working: -10~+60°C; Storage: -20~+70°C Humidity<90%RH
Power source	AA 1.5V x3 (not include)
Dimension	170mm×97mm×38mm
Weight	330g

MT-7601 Fiber Optical Power Meter



- 850-1625nm multi wavelength.
- Adapts to FC/SC/ST connectors.

ACCESSORIES

Soft bag x1
LC adapter (5MT-7601-LC)
(NOT INCLUDED)
SC adapter (5MT-7601-SC)
(NOT INCLUDED)

SPECIFICATIONS

Detector type	InGaAs
Optical connector	FC / ST / SC & 2.5mm universal
Measurement range	+6 ~ -70 dBm
Measurement wavelength	850, 1300, 1310, 1490, 1550, 1625
Accuracy	(1550nm, 1310nm)±0.2dB/ (1490nm, 1625nm)±0.3dB/ (850nm, 1300nm)±0.4dB
Measurement linearity	±2.0%
Display resolution	+6 ~ -60dBm:0.01 dB(-60 ~ -70dBm:0.1 dB)
Power display units	dBm, mW, uW
Modulation detection	270Hz, 1KHz, 2KHz
Auto power off	10 min (can be cancelled)
Low battery indication	Yes
Working time	> 100 hours
Environmental condition	Working: -10~+60°C; Storage: -20~+70°C Humidity<90%RH
Power source	AA 1.5V×2 (not included)
Dimension	165×80×35 mm
Weight	180g (without battery)

MT-7801/MT-7802 Fiber Optical Light Source



MT-7801 MT-7802



- Multi-range supply.
- Wave ID helps to identify the wavelength automatically.
- Supports SC/PC.

ACCESSORIES

Soft bag x1

SPECIFICATIONS

SPECIFICATIONS	MT-7801	MT-7802
Optical connector	SC/PC	
Measurement wavelength	1310/1550nm	850/1300nm
Modulation detection	270Hz, 1kHz,2kHz	
Output power	>-5dBm	>-10dBm
Auto power Off	10 min (can be cancelled)	
Low battery indication	Yes	
Working time	> 40 hours	
Environmental condition	Working: -10~+60°C; Storage: -20~+70°C Humidity<90%RH	
Power source	AA 1.5V×2 (not included)	
Dimension	165×80×35 mm	
Weight	280g	

MT-7501/MT-7510/MT-7530

Fiber Optical Visual Fault Locator



MT-7501



MT-7510



MT-7530



ACCESSORIES

LC adaptor (5MT-7601-LC)
(NOT INCLUDED)
Soft bag x 1

Model No.	MT-7501	MT-7510	MT-7530
Wavelength	650nm±10nm		
Output power	1 mW	10 mW	30 mW
Light source	CLASS II	CLASS IIIB	CLASS IIIB
Tested fiber length	3-5Km	8-10Km	>20Km
Power source	AA (1.5 V) x 2 (Not included)		
Connector	2.5mm universal connector for FC, ST and SC		
Operation temperature	Working: -10-55°C; Storage: -10-70°C		
OAL.(mm)	175mm		

MT-7501E/MT-7520E/MT-7530E

Fiber Optical Visual Fault Locator



MT-7501E



MT-7520E



NEW



MT-7530E

NEW



ACCESSORIES

LC adaptor (5MT-7601-LC)
(NOT INCLUDED)
Soft bag x1

Model No.	MT-7501E	MT-7520E	MT-7530E
Wavelength	650nm±10nm		
Output power	1 mW	20 mW	30 mW
Light source	CLASS II	CLASS IIIB	CLASS IIIB
Tested fiber length	3-5Km	10-14Km	>20Km
Power source	AA (1.5 V) x 2 (Not included)		
Connector	2.5mm universal connector for FC, ST and SC		
Operation temperature	Working: -10-55°C; Storage: -10-70°C		
OAL.(mm)	180mm	160mm	

FB-1688C/FB-1618C Fiber Cleaver**FB-1688C****NEW****FB-1618C****NEW**

- 5 in 1 fiber holder.
- For Ø125 µm single fiber.
- Ø250 µm (0.2mm) bare fiber.
- Ø900 µm (0.9mm) bare fiber.

- 4 in 1 fiber holder.
- For Ø125 µm single fiber.
- Ø250 µm (0.2mm) bare fiber.
- Ø900 µm (0.9mm) bare fiber.

ACCESSORIES

Collector.
Alley key.

REPLACEABLE PARTS

5FB-1688N-BLADE

ACCESSORIES

Collector.
Alley key.

REPLACEABLE PARTS

5FB-1688-BLADE

Model. No	FB-1688C	FB-1618C
Average cutting angle	≤0.5°	≤0.8°
Applicable fiber core	Single core	
Cladding diameter	125µm	
Cleaver length	5-20mm	
Blade life	≥48000 times	≥36000 times
Storage box	PP (110x120x60mm)	PP (115x102x68mm)
Product size	91x82x51mm	98x62x55mm

FB-1601/FB-1602 Fiber Cleaver**FB-1601****FB-1602**

FB-1602
(With visual fault locator)

**FB-1601****ACCESSORIES**

Micro USB charging cable.
PU zipper bag x1

SPECIFICATIONS	FB-1601	FB-1602
Cladding Diameter	125 µm	
Fiber Count Coating Diameter	Single fiber & 250µm & 900µm /3x2mm Drop cable	
Cleaver Length	5-20mm	
Cleaver Blade	24 Points	
VFL Wavelength	-	650nm±20nm
VFL Connector	-	2.5mm Universal Connector
VFL Output Power	-	1mW
Operation Mode	-	CW/2Hz Glint
Power source	-	3.7V/180mAh Li-ion / Micro USB charging
Charging	-	5V/0.2A
Dimension	80 x 68 x 62mm	
Weight	285g	310g

CP-327 Fiber Optic Stripper



NEW



- Wire spring.
- ◆ Strips the 2.0-3.0mm fiber jacket down to the 900µm buffer insulation.
- ◆ Strips the 900µm buffer insulation down to the 250µm coating.
- ◆ Strips the 250µm coating down to the glass fiber perfectly.



Material	HRC	OAL (mm)
S50C	HRC48°±2°	162

CP-328 5 in 1 Fiber Optic Stripper



- Wire spring.
- ◆ Strip 2.8-3.0mm PVC Jacket
- ◆ Strip 2.0-3.0mm Loose Tube
- ◆ Strip 2.0-2.4mm PVC Jacket
- ◆ Strip 600-900µm Buffer Coating
- ◆ Strip 250µm Buffer / Acrylate



Material	HRC	OAL (mm)
S50C	HRC48°±2°	153

8PK-326 Fiber Optic Stripper



- Wire spring.
- ◆ Strip the 1.6-3.0mm fiber jacket down to the 600-900 micron buffer coating.
- ◆ Strip the 600-900 micron buffer coating down to the 250 micron coating.
- ◆ Strip the 250 micron cable down to the glass fiber without nicks or scratches.



Material	HRC	OAL (mm)
S50C	HRC48°±2°	148

CP-FB01N FTTH Drop Cable Stripper



NEW



- Strip & cut.
- FTTH fiber 3.0 X 2.0mm/ 2.1 X 1.6mm.

Material	Application	Fiber core	OAL (mm)
Body: Zinc Alloy Blade: CR12	250µm/125µm	1	112

SR-2046 Kevlar Fiber Optic Scissors



NEW



- Wire spring.
- Stronger and high hardness blade.
- Modern and trendy sheath.

Material	Blades	OAL (mm)
PP+TPR	4043 Stainless Steel	150

DK-2043 Fiber Optic Kevlar Cutter



- Lead free.
- Serrated blade for gripping materials.
- Specially designed for cutting kevlar materials.

Material	HRC	OAL (mm)
TPR(handle)	HRC60°-62°	160

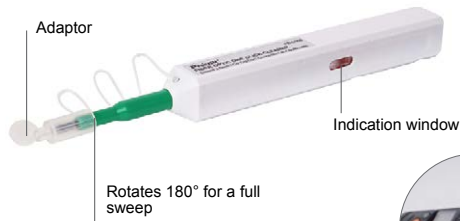
FB-C008 2.5mm Fiber Optic One Click Cleaner**NEW**

Application	Capacity	OAL (mm)
2.5 mm FC/PC/ST & SC Connectors & Bulkheads	800 times	179

FB-C009 1.25mm Fiber Optic One Click Cleaner**NEW**

Application	Capacity	OAL (mm)
1.25 mm LC Connectors & Bulkheads	800 times	179

FB-C010 Fibr Optic Connector Cleaner

The refillable cleaning tape:
Model No.5FB-C010-RPM

Application	Capacity	OAL (mm)
For cleaning SC , FC , ST , MU , LC , D4 , MT , DIN connector	500 times	115

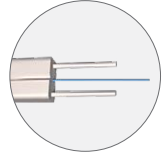
PM-806FG Precision Diagonal Cutting Pliers**NEW**

- Lead free.
- Wire spring.

Capability for cutting FRP dielectric strength

Material	HRC	OAL (mm)
60CrV / TPR	45±3°	160

8PK-MA009 Fiber Optic Viewing Scope Kit**ACCESSORIES**

1.25mm fiber optic adapter(9MA009-OD-1.25) x1
Soft bag x1

Application	Light source	Battery	OAL (mm)
200X Adjustable	LED	1.5V AA x 2 (not included)	148

8PK-C002 Foam Swabs Cleaning Kit

contains
cleaning swab x10, cloth x10, cleaning liquid x1

PK-9472A/B Fiber Optic & Telecom Installation Tool Kit



- It's professional and ideal for fiber optic & telecom installation and also comes with several useful tools, be able to perform excellent job with efficiency.



MT-7615
4 in 1 fiber Optical
Power Multimeter



MT-7029N
Noise-filtering
Network PoE Toner &
Probe Kit

MODEL	PK-9472A	PK-9472B
1PK-067DS	Dual color side cutting plier(165mm)	
1PK-709DS	Dual color long nose plier(166mm)	
9SD-202A	⊖ Pro-soft screwdriver(5x75mm)	
9SD-202B	⊕ Pro-soft screwdriver(#1 5x75mm)	
9SD-207A	⊖ Pro-soft screwdriver(6x100mm)	
9SD-207B	⊕ Pro-soft screwdriver(#2 6x100mm)	
SI-129B-60	-	Soldering iron 60W / 220~240V
SI-130A-20	Soldering iron 12W / 110~120V	
CP-3001D	Precision wire stripper (AWG 30/28/26/24/22/20)	
CP-3141	Impact terminal tool for krone	
CP-328	5 In 1 fiber optic stripper	
CP-376TR	4P/6P/8P telecom crimping tool (190mm)	
CP-FB01N	Ftth drop cable stripper	
DK-2039	Utility knife (3 blades self loading)	
DK-2043	Fiber optic kevlar cutter	
FL-528	1W LED head light	
MT-1210	3 1/2 Compact Digital Multimeter	
MT-7029N	Noise-filtering network poe toner & probe	
MT-7615	4 In 1 fiber optical power multimeter	
NT-305N	Voltage detector	
PD-2616	10 oz engineer's hammer	
TC-850-NP	ABS carrying tool case (435x310x145mm)	

PK-9461 Fiber Optic Basic Cleaning and Inspection Kit



- Ideal for removing and trapping contaminants of fiber optic connector end face in fiber optic installations.

MODEL	CONTENTS
9MS-153A	Bulb blower (ø42mm)
9FB-C008	2.5mm fiber optic one click cleaner
9FB-C009	1.25mm fiber optic one click cleaner
9FB-C010	Fiber optic cleaning cassette
9FB-C011	Lint free wiper
9C003	Cleaning liquid
9PK-MA009	Fiber optic viewing scope kit
9Z-940KP	Zipper carrying bag(280x197x70mm)

PK-9456 FTTH Fiber Optical Tool Kit

MODEL	CONTENTS
9SB-1592	Component storage box (145x92x40mm)
1PK-067DS	6" Dual color side cutting plier
1PK-709DS	6" Dual color long nose cutting plier
8PK-326	Fiber Optical Stripper
9SD-207A	⊖ Pro-soft screwdriver (6x100mm)
9SD-207B	⊕ Pro-soft screwdriver (#2x100mm)
CP-FB01N	FTTH Drop cable stripper
PD-513	Utility knife
FB-1618C	Fiber cleaver
MS-018	Leak proof dispenser pump bottle
MT-7501	1mW Fiber optic visual fault locator
MT-7601	Fiber Optic power meter
9ST-7610-BAG	Carry bag

PK-9458 Professional FTTH Fiber Optical Tool KitCP-328
5 in 1 Fiber Optic
StripperFB-1618C
Fiber cleaver with
Scrap CollectorCP-376TR
4P/6P/8P Telecom
crimping toolMT-7602
4 in 1 fiber optic
power multimeter

MODEL	CONTENTS
MT-7602	4 in 1 fiber optic power multimeter
FB-C008/FB-C009	2.5mm/1.25mm one click cleaner
FB-1618C	Fiber cleaver with Scrap Collector
CP-376TR	4P/6P/8P Telecom crimping tool
CP-FB01N	FTTH drop cable stripper
CP-328	5 in 1 Fiber Optic Stripper
1PK-067DS	Dual color side cutting plier (165mm)
9SD-207B	⊕ Pro-soft screwdriver (#2x100mm)
9SD-201A	⊖ Pro-soft screwdriver (3.0X75mm)
DK-2043	Fiber optic kevlar cutter
DK-2040	Measuring tape (3M/10FT)
MS-018	Leak proof dispenser pump bottle
FL-528	1W LED head light
PD-2612	8 Oz curved claw hammer
SB-1592	Component storage box (145 x 92 x 40mm)
9MS-153A	Bulb blower (Ø42mm)
8PK-C002	Foam swabs cleaning kit
5MT-7601-LC	Fiber optical power meter LC adapter
9PK-153	Brush
9TC-756-NP	Deluxe Aluminium Frame Tool Case(458x330x150mm)

- One kit for all fiber optic installation job.

CRIMPERS



CP-376AR**RJ45 Pass Through
Modular Crimper****NEW**

- Brand new ratchet mechanism design, provides a silky crimping experience.
- Parallel crimp action performs aligned termination & excellent connection.
- Zinc alloy body ensures accurate crimp and long service life.
- Adjustable crimp bar for fitting different connector types.
- Capable of crimping metal tail clips to protect the connection & grounding.
- Built-in round cable stripper & cutter for convenient installation.
- Extra blade storage for spare blades (total 2pcs, 1 of each) & prolong service life.

REPLACEABLE PARTS

Blade: 5CP-342-B

CP-376TN**CAT 7/6/5 Pass Through
Professional Modular Crimper****NEW**

- Works on RJ45 Open-Pass unshielded & shielded plugs.
- Crimps and trims extended wire in one step with flush out.
- Built-in cutter and stripper for flat and round cables.
- Advanced ratchet mechanism assures optimum termination.
- Dual-color grips enhance comfort when in use.

REPLACEABLE PARTS

Blade: 5PK-376C-BLADE, 5CP-376TN-B

FEATURES	CP-376AR	CP-376TN
Material	S45C/Black:T.P.R+Green:PP	
HRC	45 \pm 5*	
RJ45/CAT.6A/CAT.7	●	-
RJ45/CAT.6		●
RJ45/CAT.5/5e		●
Pass through		●
RJ11/12/6P	●	-
RJ22/4P	●	-
OAL (mm)	195	190

CP-376N Modular Crimping Tool



- 6P/8P
- Ratchet system
- For Pass Through Plug
- Parallel Crimping Action

REPLACEABLE PARTS

5CP-376N-6PB
5CP-376N-8PB
5CP-376N-BLADE
(1 pc/pack)

CP-342 End Pass Through Mini Crimper



NEW



- Compact Size
- RJ45 Cut, Strip, Crimp
- For Pass Through Plug
- Parallel Crimping Action

REPLACEABLE PARTS

Blade: 5CP-342-B

FEATURES	CP-376N	CP-342
Material	S45C / Black:T.P.R / Green:PP	S50C / Black:T.P.R / Green:PP
HRC		45 \pm 3*
RJ45/8P/CAT.6/5e/5		●
Pass through		●
RJ11/12/6P	-	●
OAL (mm)	210	143

CN-PT50C6AS/CN-PT50C6S/788-PT50C6-100/788-PT50C5-100 Modular Plug



CN-PT50C6AS



- RJ45/CAT.6a pass through plug



CN-PT50C6S



- RJ45/CAT.6 pass through plug



788-PT50C6-100



- RJ45/CAT.6 pass through plug



788-PT50C5-100



- RJ45/CAT.5e pass through plug

MODEL	CN-PT50C6AS	CN-PT50C6S	788-PT50C6-100	788-PT50C5-100
Gold plating thickness	50u"	50u"	50u"	50u"
Wire Gauge (AWG)	Solid or Stranded wire cable 22-26AWG Cable Diameter \varnothing 1.35-1.45mm	Solid or Stranded wire cable 23-26AWG Cable Diameter \varnothing 0.93-1.04 mm	Solid or Stranded wire cable 23-26AWG Cable Diameter \varnothing 0.93-1.04 mm	Solid or Stranded wire cable 23-26AWG Cable Diameter \varnothing 0.93-1.04 mm
Shielded	●	●	-	-
Package	50	100	100	100

TOOL KITS
TEST INSTRUMENTS
SOLDERING & DESOLDERING
FIBER OPTICS
CRIMPERS
PRECISION PLIERS & CUTTERS
ELECTRICAL PLIERS & CUTTER
STRIPPERS
PUNCH DOWN TOOLS
ALIGNMENT TOOL & SCREWDRIVERS
HEX KEY WRENCHES

Common Network Cables

CAT.7

Up to 10,000Mbps for data center use

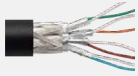

CAT.6A

Up to 10,000Mbps for sensitive data use ie. financial service



CAT.6

Up to 1,000Mbps for large corporation use

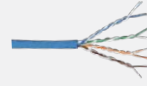

CAT.5E

Up to 100Mbps for general household use



Common RJ connectors

Pass Through Shielded CAT.7/6A Modular Plug	CAT.7/6A Modular Plug	Pass Through CAT.6/5E Modular Plug	CAT.6 Modular Plug	Shielded CAT.6 Modular Plug	CAT.5E Modular Plug	Shielded CAT.5E Modular Plug

CP-376TA CAT.7 Modular Plug Crimping Tool



- Capable of cutting, stripping & crimping.
- Ratchet mechanism design for crimping force saving & pressure released.
- Additional baffle from blade for user's safety.

REPLACEABLE PARTS

Blade: 5CP-376TA-B (6 pcs/set)

CP-335N CAT.7 Modular Plug Crimping Tool

NEW

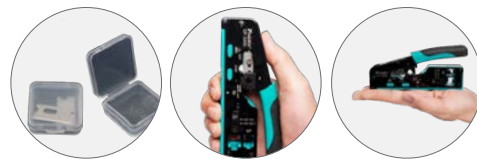

- Parallel Crimping Action
- Force Saving
- Capable for cutting, stripping & crimping.

ACCESSORIES

Blade storage box x1
Spare blade x2

FEATURES	CP-376TA	CP-335N
Material	S50C / Black:T.P.R / Green:PP	Medium carbon steel / TPR
HRC	45 ±3°	-
RJ45/CAT.7		●
RJ45/CAT.6/6a		●
RJ45/CAT.5/5e		●
RJ11/12/6P	-	●
OAL (mm)	190	142

CP-376VR/CP-376UR/CP-376K/CP-200R Professional Modular Crimping Tool



CP-376VR



CP-376UR



CP-376K



CP-200R



- For crimping modular plugs in parallel action.
- Cut, strip, and crimp modular plugs without changing modular (DIE) set.
- Smooth ratcheting mechanism ensures positive connections.
- Integrated with round cable stripper for stripping round cables effectively in one operation.
- Middle carbon steel frame, hardened & black oxide finish.
- Lightweight, durable and compact.

REPLACEABLE PARTS

Blade: 5CP-376U-BLADE (6 pcs/set)

FEATURES	CP-376VR	CP-376UR	CP-376K	CP-200R
Material	S45C / Black:T.P.R / Green:PP			
HRC	45 \pm 3'			
RJ45/8P/CAT.6/5e/5		●		
RJ11/12/6P/DEC	-		●	●
RJ22/4P	-		●	●
RJ50/10P		-		●
OAL (mm)	195	195	205	205

CP-376TR/808-376H/808-376C**Modular Crimping Tool****CP-376TR****808-376H****808-376C**

- For 4P/6P/8P modular.
- Ratchet mechanism.

- For 6P/8P modular plug.

- For 6P/8P modular plug.

**REPLACEABLE PARTS**

Blade : 5PK-376C-BLADE (6 pcs/set)

REPLACEABLE PARTS

Blade : 5PK-376C-BLADE (6 pcs/set)

REPLACEABLE PARTS

Blade : 5PK-376C-BLADE (6 pcs/set)

- Wire spring.



Crimping

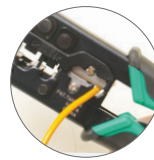

Strips twisted pair wire

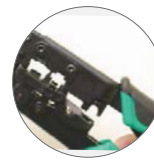

Cutting



Strips flat telephone wire

FEATURES	CP-376TR	808-376H	808-376C
Material	S45C / Black:T.P.R / Green:PP	Low carbon steel / Handle:PP	Low carbon steel / Handle:PVC
Hardness	HRC 45 \pm 3 $^{\circ}$	HR 30N 55 \sim 65 $^{\circ}$	
RJ45/8P/CAT.6/5e/5		●	
RJ11/12/6P		●	
RJ22/4P	●		
OAL (mm)	190	190	200



CP-376M



CP-376ER



CP-376D



REPLACEABLE PARTS

Blade : 508-376ER-B (2pcs/pack)

REPLACEABLE PARTS

Blade : 508-376ER-B (2pcs/pack)

REPLACEABLE PARTS

Blade : 508-376E-B (2pcs/pack)

- Wire spring.
- Accurate – Crimping performance is accurate.
- Practical – Ratchet, high leverage design
- Comfortable – Ergonomically shaped non-slip handle
- Convenient – Cutting, stripping, and crimping all in one design



Stripping



Crimping



Cutting

FEATURES	CP-376M	CP-376ER	CP-376D
Material	S45C / Black:T.P.R / Green:PP		
HRC	45°±3'		
RJ45/8P/CAT.6/5e/5		●	
RJ11/12/6P		●	
RJ22/4P	●	-	-
OAL (mm)	225	216	200

CP-333/CP-373/CP-393 Modular Crimping Tool

- Cut, strip, crimp, 3 in 1.
- Light weight & compact size.



Cutting round cable



Stripping UTP/STP round cable



Crimping 6P/8P



CP-333



- Force Saving
- Parallel crimping

REPLACEABLE PARTS

Blade : 5CP-333-B (3pcs/pack)



CP-373



REPLACEABLE PARTS

Blade : 5CP-376U-BLADE



CP-393

- Economic type

FEATURES	CP-333	CP-373	CP-393
Material (body / handle)	ABS+Carbon Steel / PVC	ABS+Carbon Steel	
RJ45/8P/CAT.6/5e/5		●	
RJ11/12/6P		●	
RJ22/4P	-		●
OAL (mm)	143	160	160

CP-376CN/CP-376KX/CP-376E/8PK-376FN Modular Crimping Tool



CP-376CN

- Parallel crimping



REPLACEABLE PARTS

Blade : 5CP-376CN-B



CP-376KX

- Parallel crimping
- Ratchet mechanism
- Economic type



CP-376E



REPLACEABLE PARTS

Blade : 5CP-376E-B (2pcs/pack)



8PK-376FN

- Parallel crimping



REPLACEABLE PARTS

Blade : 508-376E-B (2pcs/pack)

FEATURES	CP-376CN	CP-376KX	CP-376E	8PK-376FN
Material	Carbon Steel / PP+TPR	Carbon Steel / PP+TPR	S45C / PP	Nylon+Fiber
RJ45/8P/CAT.6/5e/5			●	
RJ11/12/6P/DEC	-	●		
RJ22/4P	-	●		●
OAL (mm)	195	200	210	166

1PK-CT006 Splice & Crimp Tool



- Designed for UG, UR and UY connectors.
- A special stop behind cutout prevents connectors from damage.

Material	HRC	Crimp size	OAL (mm)
S45C / Handle:PVC	45°±3°	Solid copper wire UR:19 to 26 AWG UY:22 to 26 AWG UG:19 to 26 AWG	150

CP-148 Telecom Combi-Crimper

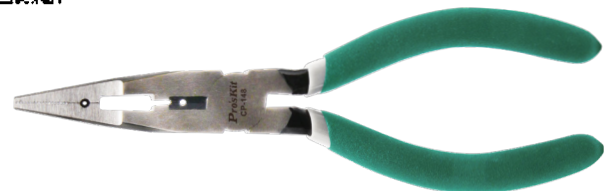

- Stripper: 0.8 and 1.4mm stripping holes for AWG 24/22 & 20/18/16 (Ø0.5/0.6/0.8/1.0/1.3mm) wires.
- Plier: Long nose design for easy wire bending, pulling and holding.

Material	HRC	Crimp size	OAL (mm)
S55C / Handle:PVC	45°±3°	For UR/UY/UG, AMP tel splice connector, 709 series connectors.	168

TOOL KITS
TEST INSTRUMENTS
SOLDERING & DESOLDERING
FIBER OPTICS
CRIMPERS
PRECISION PLIERS & CUTTERS
ELECTRICAL PLIERS & CUTTER
STRIPPERS
PUNCH DOWN TOOLS
ALIGNMENT TOOL & SCREWDRIVERS
HEX KEY WRENCHES

CP-371 Crimp Pro Crimp Frame

- Wire spring.
- 30% force saving.
- Angled head design prevents awkward wrist bending during operation.
- Interchangeable die with thumbscrews.

Material	HRC	Die replacement style	OAL (mm)
S45C / Black:T.P.R / Green:PP	45 \pm 3 $^{\circ}$	Thumbscrews	236(9")

Change die with
thumbscrews.



Crimping pressure
adjustment



Ratcheting release trigger

CP-336F Lunar Crimp Frame

- Compact size, easy to carry.
- One hand operation.

Material	HRC	Die replacement style	OAL (mm)
S45C / Black:T.P.R / Green:PP	45 \pm 3 $^{\circ}$	Thumbscrews	220(8.5")

Crimping pressure
adjustment



Ratcheting release trigger

1PK-3003F Ergo-Lunar Crimp Frame

- 40%~50% crimping force saving.
- Interchangeable die with thumbscrews.

Material	HRC	Die replacement style	OAL (mm)
S45C / Handle:PP	45 \pm 3 $^{\circ}$	Thumbscrews	260(10")

Change die with
thumbscrews



Crimping pressure
adjustment

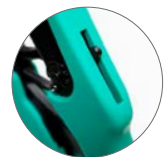

Ratcheting release trigger

Model No.	Die Set	Crimp die profile	Application	Crimp Size	Terminals	Model No.	Die Set	Crimp die profile	Application	Crimp Size	Terminals
Coaxial Connectors						Fiber Optic Connectors					
CP-336DC			RG58, RG59, RG62, RG6	HEX .068", .213", .256", .319" HEX 1.73, 5.41, 6.50, 8.10 mm		CP-336DF2			SMA, SMB, FC Biconic and SC & ST fiber optic connectors, RG58, RG174, Belden 8218	SQ.042", HEX .068", .151", .178", .213" SQ 1.07 mm HEX 1.73, 3.84, 4.52, 5.41 mm	
CP-336DI			RG58, RG59, RG6, RG174	HEX .067", .093", .211", .255", .315" HEX 1.70, 2.36, 5.36, 6.48, 8.00 mm		CP-336DV			SMA, SMB, SMC, MCX	SQ .043", HEX .069", .100", .128", .151", .213", SQ 1.09 mm HEX 1.75, 2.54, 3.25, 3.84, 5.41 mm	
CP-336DP1			RG type cables 55, 58, 59, 5, 6, 21, 141, 142, 143, 210, 212, 222, 223, 303, 304, 400, Belden: 8279, 8281, 9231 & 9141	HEX .068", .098", .213", .255", .321" HEX 1.73, 2.49, 5.41, 6.48, 8.15 mm		CP-336DG			RG58, RG59, RG62, RG174 fiber optic	SQ .043", HEX .068", .100", .137", .213", .255", SQ 1.09 mm HEX 1.73, 2.54, 3.48, 5.41, 6.48 mm	
1PK-3003D3			Cambridge CP-88, CP-89 BNC/TNC coax connectors with RG58, RG59, RG62/AU cables	SQ .068", HEX .228", .305", SQ 1.73 mm HEX 5.79, 7.75 mm		CP-336DJ			RG174, RG179, Belden 8218 fiber optic	SQ .042", HEX .068", .078", .128", .151", .178", SQ 1.07, HEX 1.73, 1.98, 3.25, 3.84, 4.52 mm	
1PK-3003D6			N-Series and RG8, RG11 Connectors	HEX .080", .100", .429", HEX 2.03, 2.54, 10.90 mm		CP-336DK4			RG58, RG174, fiber optic	HEX .100", .128", .190", .213", HEX 2.54, 3.25, 4.83, 5.41 mm	
1PK-3003D8			RG58, RG6, RG174, Belden type RG8281 cables	HEX .068", .178", .324", HEX 1.73, 4.52, 8.23 mm		Electrical And Industrial Terminals					
1PK-3003D9			Plenum and teflon cables, RG58, RG59	HEX .042", .068", .190", .213", HEX 1.07, 1.73, 4.83, 5.41 mm		CP-236DR			Vinyl insulated W/O copper sleeve	AWG 22-18/16-14/12-10, DIN 0.5-1.0/1.5-2.5/4.0-6.0mm ² JIS 1.25/2.0/3.5-5.5mm ²	
1PK-3003D10			RG59, RG6, RG8281, F-type CATV Connectors	HEX .255", .320", .350", HEX 6.48, 8.13, 8.89 mm		1PK-3003D21			Insulated terminals & plugs for smaller wire barrel terminals	AWG 26-22/22-18/16 DIN 0.1-0.32/0.32-0.82/1.5mm ² JIS 0.1-0.30/0.30-0.75/1.25 mm ²	
Modular Plugs						1PK-3003D1			Insulated terminals/ color coded nests	AWG 22-18/16-14/12-10, DIN 0.5-1.0/1.5-2.5/4.0-6.0 mm ² JIS 1.25/2.0/5.5 mm ²	
1PK-3003D11			8P8C/RJ45 keyed modular plugs (excluding AMP)			CP-236DN			Non-insulated terminals & plugs	AWG 20-18/16-14/12-10/8, DIN 1.5/2.5/6.0/10.0 mm ² JIS 1.25/2.0/3.5-5.5/8.0 mm ²	
1PK-3003D12			6P2C/6P4C/6P6C RJ11/RJ12 modular plugs			CP-236DE1			Pin terminal insulated & non-insulated wire ferrules	AWG 10/8/6 DIN 6.0/10.0/16.0 mm ² JIS 5.5/8.0/14.0 mm ²	
1PK-3003D14			AMP 8P8C/RJ45 modular plugs. Primary strain relief crimp bar is located further back on die/modular plugs			CP-236DE			Pin terminal insulated & non-insulated wire ferrules	AWG 22/20/18/16/14/12 DIN 0.5/0.75/1.0/1.5 2.5/4.0 mm ² JIS 0.35/0.5/0.9/1.25/2.0/3.5 mm ²	
1PK-3003D16			RJ22 4P2C/4P4C handset modular plugs			CP-236DU			Non-insulated open barrel connectors & D-SUB V.35 terminal	AWG 22/14 DIN 0.5/2.5 mm ² JIS 0.35/2.0 mm ²	
Solar Terminals						CP-3003D45			Non-insulated open barrel connectors	AWG 22-18/16-14/12-10, DIN 0.5-1.0/1.5-2.5/4.0-6.0 mm ² JIS 0.5-0.9/1.25-2.0/3.5-5.5 mm ²	
CP-5S1D			For MC 3 solar connector (Multi-Contact) & 2.5/4.0/6.0 mm ² (AWG 14/12/10) solar cable	AWG 14/12/10 DIN 2.5/4.0/6.0mm ²		CP-3003D47			Non-Insulated open barrel connectors commercial type	AWG 20-18/16-14/12-10, DIN 0.5-1.0/1.5-2.5/4.0-6.0mm ² JIS 0.5-1.0/1.25-2.0/3.5-5.5 mm ²	
CP-5S2D			For MC 4 solar connector (Multi-Contact) & 2.5/4.0/6.0 mm ² (AWG 14/12/10) solar cable	AWG 14/12/10 DIN 2.5/4.0/6.0mm ²		1PK-3003D36			Non-insulated open barrel connectors & D-SUB V.35 contact pins	AWG 30-24/22-18 DIN 0.05-0.25/0.50-1.0mm ² , JIS 0.05-0.25/0.35-0.9mm ²	
						1PK-3003D2			Non insulated open barrel connectors, commercial type	AWG 22-18/16-14/12-10, DIN 0.5-1.0/1.5-2.5/4.0-6.0 mm ² JIS 0.35-0.9/1.25-2.0/3.5-5.5 mm ²	

TOOL KITS
TEST INSTRUMENTS & DISASSEMBLING
SOLDERING
FIBER OPTICS
CRIMPERS
PRECISION PLIERS & CUTTERS
ELECTRICAL PLIERS & CUTTER
STRIPPERS
PUNCH DOWN TOOLS
ALIGNMENT TOOL & SCREWDRIVERS
HEX KEY WRENCHES

CP-3006 Series Parallel Action Crimping Tool



Interchangeable crimp dies with one grip



Material	HRC	OAL (mm)
S50C / TPR	45 \pm 3°	254(10")

Model No.	Die set	Crimp die profile	Application & Crimp Size	Terminals
CP-3006FD2			Non-insulated open barrel connectors, commercial type AWG 22-18/16-14/12-10 DIN 0.5-1.0/1.5-2.5/4.0-6.0 mm ² JIS 0.35-0.9/1.25-2.0/3.5-5.5 mm ²	
CP-3006FD18			Pin terminal insulated or non-insulated ferrules, cord end terminals AWG 22/20/18/16/14/12 DIN 0.5/0.75/1.0/1.5/2.5/4.0 mm ² JIS 0.35/0.5/0.9/1.25/2.0/3.5 mm ²	
CP-3006FD36			Non-insulated open barrel connectors & D-SUB V.35 contact pins AWG 30-24/22-18 DIN 0.05-0.25/0.50-1.0 mm ² JIS 0.05-0.25/0.35-0.9 mm ²	
CP-3006FD45			Non-insulated open barrel connectors AWG 22-18/16-14/12-10 DIN 0.5-1.0/1.5-2.5/4.0-6.0 mm ² JIS 0.5-0.9/1.25-2.0/3.5-5.5 mm ²	
CP-3006FD47			Non-insulated open barrel connectors commercial type AWG 20-18/16-14/12-10 DIN 0.5-1.0/1.5-2.5/4.0-6.0 mm ² JIS 0.5-1.0/1.25-2.0/3.5-5.5 mm ²	
CP-3006FS1			For MC 3 solar connector (Multi-Contact) & 2.5/4.0/6.0 mm ² (AWG 14/12/10) solar cable AWG 14/12/10 DIN 2.5/4.0/6.0 mm ²	
CP-3006FS2			For MC 4 solar connector (Multi-Contact) & 2.5/4.0/6.0 mm ² (AWG 14/12/10) solar cable AWG 14/12/10 DIN 2.5/4.0/6.0 mm ²	

6PK-230/301 Series Crimping Tool



Ratcheting release trigger



Material	HRC	OAL (mm)
S45C / Green: PP Black: TPR	45 \pm 3°	220(8.5")

Model No.	Die set	Crimp die profile	Application & Crimp Size	Terminals
6PK-230C			AWG 20-18/16-14/12-10 DIN 0.5-1.0/1.5-2.5/4.0-6.0 mm ² JIS 0.5-0.9/1.25-2.0/3.5-5.5 mm ²	
6PK-230PA			55, 58, 59, 5, 6, 21, 141, 142, 143, 210, 212, 222, 223, 303, 304, 400 Belden: 8279, 8281, 9231 & 9141 HEX .068", .098", .213", .255", .321" HEX 1.73, 2.49, 5.41, 6.48, 8.15 mm	
6PK-301E			Pin terminal insulated & non-insulated wire ferrules AWG 22/20/18/16/14/12 DIN 0.5/0.75/1.0/1.5/2.5/4.0 mm ² JIS 0.35/0.5/0.9/1.25/2.0/3.5 mm ²	
6PK-301H			Insulated terminals & plugs AWG 22-18/16-14/12-10 DIN 0.5-1.0/1.5-2.5/4.0-6.0 mm ² JIS 1.25/2.0/3.5-5.5 mm ²	
6PK-301N			Non-insulated terminals & plugs AWG 20-18/16-14/12-10/8 DIN 1.5/2.5/6.0/10.0 mm ² JIS 1.25/2.0/3.5-5.5/8.0 mm ²	
6PK-301R			Vinyl insulated W/O copper sleeve AWG 22-18/16-14/12-10 DIN 0.5-1.0/1.5-2.5/4.0-6.0 mm ² JIS 1.25/2.0/3.5-5.5 mm ²	
6PK-301S			Pin terminal insulated & non-insulated wire ferrules	
6PK-301U			Non-insulated open barrel connectors & D-SUB V.35 terminal AWG 22/14 DIN 0.5/2.5 mm ² JIS 0.35/2.0 mm ²	
8PK-301C			RG58, RG59, RG62, RG6 HEX .068", .213", .256", .319" HEX 1.73, 5.41, 6.50, 8.10 mm	
8PK-301J			RG174, RG179, Belden 8218 fiber optic SQ .042", HEX .068", .078", .128", .151", .178" SQ 1.07, HEX 1.73, 1.98, 3.25, 3.84, 4.52 mm	

CP-462G/CP-460G/CP-463G Ferrule Crimping Tool



CP-460G

NEW



CP-463G

NEW



CP-462G



Hexagonal Crimp



- Insulated/Non-insulated
- Ergonomic Handle
- Ratchet Mechanism

FEATURES	CP-460G	CP-463G	CP-462G
Material	S45C / Fe8Ni / PVC (body / die / handle)		
HRC	40°±2° / 50°±2° (body / die)		
Crimp type	Square	Hexagonal	Square
Crimp size	28-10 AWG (0.08-6.0mm ²)	23-10 AWG (0.25-6.0mm ²)	28-7 AWG (0.08-10mm ²)
OAL (mm)	156	175	175

CP-751 Series 7.5" Crimping Tool



Model No.	Die set	Crimp die profile	Application & Crimp Size	Terminals
CP-751A			Non-insulated open barrel connectors for width 2.0/2.54/3.96mm PH/XH/D-SUB/SM/EL/KF/VH/CH/5557/2.8/4.8 AWG: 30-24/22-18, DIN: 0.05-0.25/0.34-1.0mm ² , JIS: 0.05-0.25/0.35-0.9mm ²	
CP-751B			AWG: 16/14/12-10, DIN: 1.5/2.5/4.0-6.0mm ² , JIS: 1.25/2.0/3.5-5.5mm ²	
CP-751C			AWG: 20-18/16-14, DIN: 0.5-1.0/1.5-2.5mm ² , JIS: 0.5-0.9/1.25-2.0mm ²	
CP-751E			AWG: 20-18/17-16/14/12/10, DIN: 0.5-0.75/1.0-1.5/2.5/4.0/6.0mm ² , JIS: 0.5-0.75/0.9-1.25/2/3.5/5.5mm ²	
CP-751H			AWG: 24-20/20-16/16-14, DIN: 0.25-0.5/1.5/2.5mm ² , JIS: 0.3-0.5/1.25/2mm ²	
CP-751N			AWG: 22-18 / 18-16 / 16-14, DIN: 0.35-0.75/0.75-1.5/1.5-2.5mm ² , JIS: 0.35-0.75/0.75-1.25/1.25-2mm ²	
CP-751PA			HEX: 0.213", 0.256", 0.068", HEX: 5.41 / 6.5 / 1.73mm	



- 7.5" 190mm Compact Size.
- Ratchet Mechanism.
- Adjustable Crimping Pressure.

CP-151A/CP-151B/CP-251B/CP-351B/CP-353 Non-Insulated Terminals Ratchet Crimping Tool



CP-151A



CP-151B



CP-251B



CP-351B



CP-353



MODEL	Material	HRC Body	Handle	Application	OAL (mm)
CP-151A	Frame:S45C Die: AISI 4140	43°~45°	TPR	"Non-insulated spade/ring terminals,AWG 20/16/14/12, DIN 0.75/1.5/2.5/4mm ² JIS 0.5/1.25/2.0/3.5mm ² "	176
CP-151B				"Non-insulated spade/ring terminals,AWG 22-16/16-14/12/10, DIN 1.5/2.5/4.0/6.0 mm ² JIS 1.25/2.0/3.5/5.5 mm ² "	176
CP-251B				"Non-insulated spade/ring terminals,AWG 22-16/16-14/12-10/8/6,DIN 1.5/2.5/6.0/10/16 mm ² JIS 1.25/2.0/5.5/8.0/14 mm ² "	245
CP-351B				"Non-insulated spade/ring terminals, AWG 8/6/4/2, DIN 10/16/25/35 mm ² JIS 8/14/22/38 mm ² "	350
CP-353				"AWG 12-10 / 8 / 6 / 4, DIN 4-6 / 10 / 16 / 25 mm ² JIS 5.5 / 8.0 / 14 / 22 mm ² "	332

CP-384N D-Sub Contact Crimping Tool



- 30%Force Saving

Material	Frame: S50C / Die: AISI 4140 / Handle: TPR
HRC Body	44±1°
Application	Non-insulated open barrel connectors for pice width 2.0/2.54/3.96mm PH/XH/D-SUB/SM/EL/KF/VH/CH/5557/2.8/4.8
Crimp Size.(mm)	AWG: 30-24/22-18 DIN/ 0.05-0.25/0.5-1.0mm ² JIS 0.05-0.25/0.35-0.9mm ²
OAL (mm)	225

608-384N D-Sub Contact Crimping Tool



- For female & male D-SUB miniature contacts.

Material	Frame: S50C / Die: AISI 4140 / Handle: PP
HRC Body	45±3°
Application	Non-insulated open barrel connectors & D-SUB V.35 contact pins
Crimp Size.(mm)	AWG: 30-24/22-18 DIN/ 0.05-0.25/0.5-1.0mm ² JIS 0.05-0.25/0.35-0.9mm ²
OAL (mm)	205



CP-315/CP-313 Adjustable Compression Tool



MODEL	CP-315	CP-313
Material	S45C / Handle: Nylon+Fiber	Carbon steel / Handle: PVC
HRC	45 \pm 5 $^{\circ}$	40 \pm 5 $^{\circ}$
Application	Connecting waterproof connectors BNC, F, RCA on RG58, RG59, RG6 (3C, 4C, 5C) coaxial	Connecting waterproof connectors BNC, F, RCA on RG58, RG59, RG6 (3C, 4C, 5C) coaxial
OAL (mm)	120	152

8PK-CT120 / 8PK-CT150 Heavy Duty Crimping Tool



8PK-CT120

- For terminating cable lugs.
- Non-ratchet screw adjustment design.
- The best crimping solution for heavy duty tinned terminals.
- Adjustable crimp nests with clearly marked gauges.



8PK-CT150



FEATURES	8PK-CT120	8PK-CT150
Material	Body: AISI 1021 Die: SCM440 Handle: FCD45	Body: FCD45 Die: SCM440 Handle: Iron pipe+PVC
Crimp type	Cable lugs	Cable lugs
Crimp size	AWG 8, 6, 4, 2, 1/0, 2/0, 3/0 (250 MCM) DIN 10, 16, 25, 35, 50, 70, 95, 120 mm ²	AWG 8, 6, 4, 2, 1/0, 2/0, 3/0, 4/0, 5/0 (300 MCM) DIN 10, 16, 25, 35, 50, 70, 95, 120, 150mm ²
OAL (mm)	570	670

6PK-214 IDC Crimp Tool



- For crimping IDC-type of connectors on ribbon cable.



Material	HRC	Crimp type	Crimp size	OAL (mm)
Low Carbon Steel / PVC	45 \pm 3 $^{\circ}$	IDC-type connectors	Max width: 55mm Height: 6-27.5mm	240

PM-804 Multi-Crimp Tool



- Wire cutter in nose.
- Plastic-coated handle.



Material	HRC	Crimp type	Crimp size	OAL (mm)
High Carbon Steel / PVC	42 \pm 3 $^{\circ}$	Non-insulated open barrel connectors	Cutting hard steel ϕ 1.6mm Crimping: 10~22 AWG	248

CP-463 D-Sub Contact Crimping Tool



- 4 Way to Crimping

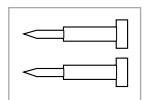

Material	HRC	Crimp type	Crimp size	OAL (mm)
SPCC+Carbon Steel	45 \pm 3 $^{\circ}$	D-Sub contact	Crimping of closed-barrel RS-232 D-sub contacts AWG 20-12 / DIN 0.5~4.0mm ² / JIS 0.5~3.5mm ²	165

PRECISION PLIERS & CUTTERS



PM-5101-C Heavy Duty Cutting Plier

- Wire spring.

Material	HRC Body	HRC Cutting edge	Copper	OAL (mm)
S50C	50'±3'	50'±3'	Ø 2.0mm	130

Safety clip design

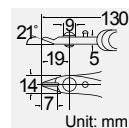
**PM-30D Micro Cutting Plier**

- Wire spring.

Material	HRC Body	HRC Cutting edge	Copper	OAL (mm)
SK7	50'±3'	50'±3'	Ø 1.6mm	135

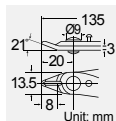
**PM-101D Micro Cutting Plier**

- Wire spring.

Material	HRC Body	HRC Cutting edge	Copper	OAL (mm)
SK7	50'±3'	50'±3'	Ø 1.3mm	135

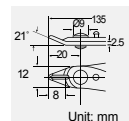
**8PK-30D Micro Cutting Plier**

- Wire spring.

Material	HRC Body	HRC Cutting edge	Copper	OAL (mm)
SK7	50'±3'	50'±3'	Ø 1.6mm	125

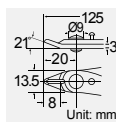
**8PK-25PD Micro Cutting Plier**

- Wire spring.

Material	HRC Body	HRC Cutting edge	Copper	OAL (mm)
SK7	50'±3'	50'±3'	Ø 1.3mm	130

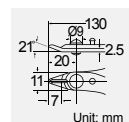
**8PK-101D Micro Cutting Plier**

- Wire spring.

Material	HRC Body	HRC Cutting edge	Copper	OAL (mm)
SK7	50'±3'	50'±3'	Ø 1.3mm	130

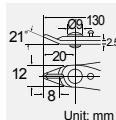
**8PK-102D Long Nose Plier**

- Wire spring.
- Serrated tip.

Material	HRC Body	HRC Cutting edge	Copper	OAL (mm)
SK7	50'±3'	-	-	145

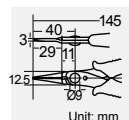

1PK-30-E Micro Cutting Plier 



- Wire spring.
- ESD safe.

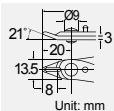

Material	HRC Body	HRC Cutting edge	Copper	OAL (mm)
SK7	50°±3°	50°±3°	Ø 1.6mm	125

1PK-211 Clean Cut Micro Nipper 



- Wire spring.
- ESD safe.

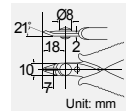

Material	HRC Body	HRC Cutting edge	Copper	OAL (mm)
SK7	50°±3°	50°±3°	Ø 0.8mm	120

1PK-209 Clean Cut Micro Nipper 



- Wire spring.
- ESD safe.

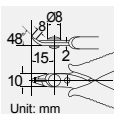

Material	HRC Body	HRC Cutting edge	Copper	OAL (mm)
SK7	50°±3°	50°±3°	Ø 0.6mm	120

1PK-101-E Micro Cutting Plier 



- Wire spring.
- ESD safe.

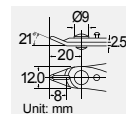

Material	HRC Body	HRC Cutting edge	Copper	OAL (mm)
SK7	50°±3°	50°±3°	Ø 1.3mm	130

1PK-5102-E Heavy Duty Long Nose Plier 



- Wire spring.
- Serrated tip.
- ESD safe.

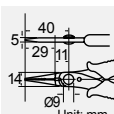

Material	HRC Body	HRC Cutting edge	Copper	OAL (mm)
S50C	50°±3°	-	-	140

1PK-5101-E Heavy Duty Cutting Plier 



- Wire spring.
- ESD safe.

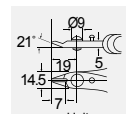

Material	HRC Body	HRC Cutting edge	Copper	OAL (mm)
S50C	50°±3°	50°±3°	Ø 2.0mm	125

1PK-5101-CE Heavy Duty Cutting Plier 



- Wire spring.
- Safety clip.
- ESD safe.

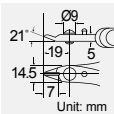

Material	HRC Body	HRC Cutting edge	Copper	OAL (mm)
S50C	50°±3°	50°±3°	Ø 2.0mm	125

1PK-25P-E Micro Cutting Plier 



- Wire spring.
- ESD safe.

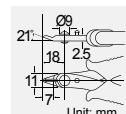

Material	HRC Body	HRC Cutting edge	Copper	OAL (mm)
SK7	50°±3°	50°±3°	Ø 1.3mm	130

1PK-25P-CE Micro Cutting Plier

- Wire spring.
- Safety clip.
- ESD safe.

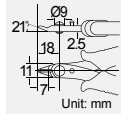

Material	HRC Body	HRC Cutting edge	Copper	OAL (mm)
SK7	50°±3°	50°±3°	Ø 1.3mm	130

1PK-105-E Bent Nose Plier

- Wire spring.
- Serrated tip.
- ESD safe.

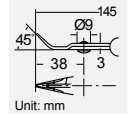

Material	HRC Body	HRC Cutting edge	Copper	OAL (mm)
SK7	50°±3°	-	-	145

1PK-104-E Flat Nose Plier

- Wire spring.
- Smooth tip.
- ESD safe.

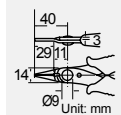

Material	HRC Body	HRC Cutting edge	Copper	OAL (mm)
SK7	50°±3°	-	-	145

1PK-102-E Long Nose Plier

- Wire spring.
- Serrated tip.
- ESD safe.

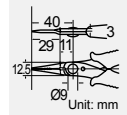

Material	HRC Body	HRC Cutting edge	Copper	OAL (mm)
SK7	50°±3°	-	-	145

PM-396H Stainless Flat Nose Plier

- Smooth tip.

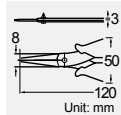

Material	HRC	Copper	OAL (mm)
AISI 420	43°±3°	-	120

PM-396G Stainless Long Nose Plier

- Smooth tip.

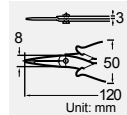

Material	HRC	Copper	OAL (mm)
AISI 420	43°±3°	-	120

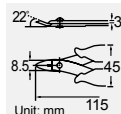
PM-396F Stainless Cutting Plier

Material	HRC	Copper	OAL (mm)
AISI 420	48°±3°	Ø 1.3mm	115

PM-396I Stainless Bent Nose Plier

- Smooth tip.

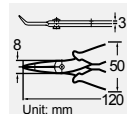

Material	HRC	Copper	OAL (mm)
AISI 420	43°±3°	-	120

1PK-066N 2 in 1 Wire Stripper/Cutter

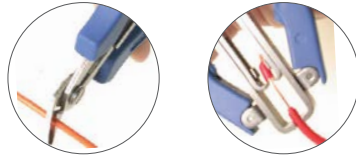

- Wire spring.
- Lead free.

Material	HRC Body	Cutter	Stripper	OAL (mm)
AISI 420	48 \pm 3 $^\circ$	\varnothing 1.2mm	0.4~1.6mm ² (26~14AWG)	130



8PK-101KM Heavy Duty Cutting Plier



- Wire spring.

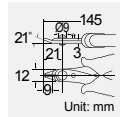

Material	HRC Body	HRC Cutting edge	Soft steel	Copper	OAL (mm)
SAE 1085	55 \pm 3 $^\circ$	55 \pm 3 $^\circ$	\varnothing 1.2mm	\varnothing 2.3mm	145

PM-107C/PM-107 Micro Cutting Pliers



PM-107C

PM-107



- Wire spring.
- Safety clip. (For PM-107C)

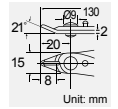

Material	HRC Body	HRC Cutting Edge	Soft steel	Copper	OAL (mm)
SK5	50 \pm 3 $^\circ$	50 \pm 3 $^\circ$	\varnothing 0.8mm	\varnothing 1.6mm	130

8PK-101K Micro Cutting Plier



- Wire spring.

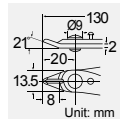

Material	HRC Body	HRC Cutting edge	Soft steel	Copper	OAL (mm)
SK5	50 \pm 3 $^\circ$	55 \pm 3 $^\circ$	\varnothing 0.8mm	\varnothing 1.6mm	130

PA-101 Micro Cutting Plier



- Wire spring.

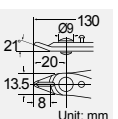

Material	HRC Body	HRC Cutting edge	Copper	OAL (mm)
65Mn	50 \pm 2 $^\circ$	50 \pm 2 $^\circ$	\varnothing 1.3mm	130

1PK-396B Long Nose Plier



- Wire spring.
- Serrated tip.

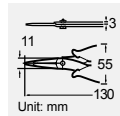

Material	HRC Body	Copper	OAL (mm)
420J2	48 \pm 3 $^\circ$	-	130

1PK-396A Cutting Plier



- Wire spring.

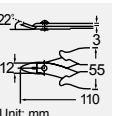

Material	HRC Body	Copper	OAL (mm)
420J2	48 \pm 3 $^\circ$	\varnothing 1.3mm	110

1PK-501C Micro Bent Nose Plier

- Wire spring.
- Smooth tip.

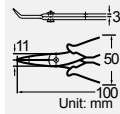

Material	HRC Body	Cutting edge	Copper	OAL (mm)
420J2	48°±3°	-	-	100

1PK-501E Micro Long Nose Plier

- Wire spring.
- Smooth tip.

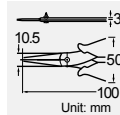

Material	HRC Body	Cutting edge	Copper	OAL (mm)
420J2	48°±3°	-	-	100

PM-251 Cutting Plier

- Wire spring.

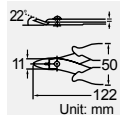

Material	HRC Body	Cutting edge	Copper	OAL (mm)
420J2	48°±3°	-	Ø 1.3mm	122

1PK-5101 Heavy Duty Cutting Plier

- Wire spring.

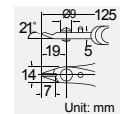

Material	HRC Body	HRC Cutting edge	Copper	OAL (mm)
S50C	50°±3°	50°±3°	Ø 2.0mm	125

1PK-501A Micro Cutting Plier

- Wire spring.

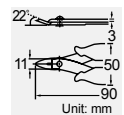

Material	HRC Body	Cutting Edge	Soft steel	Copper	OAL (mm)
420J2	48°±3°	-	-	Ø 1.3mm	90

1PK-5101-C Heavy Duty Cutting Plier

Design prevents flying leads



- Wire spring.
- Safety clip.

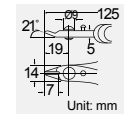

Material	HRC Body	HRC Cutting edge	Copper	OAL (mm)
S50C	50°±3°	50°±3°	Ø 2.0mm	125

1PK-258A Side Cutter

- Leaf spring.

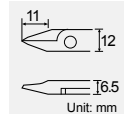

Material	HRC Body	HRC Cutting edge	Copper	OAL (mm)
S55C	43°±3°	53°±3°	Ø 1.0mm	125

PM-731 Mini Lineman's Plier



- Leaf spring.
- Serrated tip.

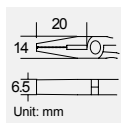

Material	HRC Body	HRC Cutting edge	Copper	OAL (mm)
S45C	43°±3°	50°~55°	Ø 1.0mm	118

PM-736 Long Nose Plier



- Wire spring.
- Serrated tip.

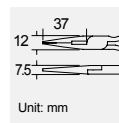

Material	HRC Body	HRC Cutting edge	Copper	OAL (mm)
S45C	43°±3°	50°~55°	Ø 1.0mm	132

PM-737 Diagonal Cutting Plier



- Wire spring.

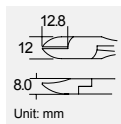

Material	HRC Body	HRC Cutting edge	Copper	OAL (mm)
S45C	43°±3°	50°~55°	Ø 1.0mm	109

PM-746 Needle Nose Plier



- Leaf spring.
- Smooth tip.

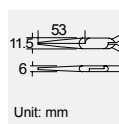

Material	HRC Body	Cutting edge	Copper	OAL (mm)
S45C	43°±3°	-	-	150

PM-754 Flat Nose Plier



- Wire spring.
- Serrated tip.

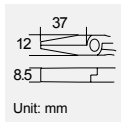

Material	HRC Body	Cutting edge	Copper	OAL (mm)
S45C	43°±3°	-	-	135

PM-755 Bent Nose Plier



- Wire spring.
- Serrated tip.

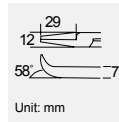

Material	HRC Body	Cutting edge	Copper	OAL (mm)
S45C	43°±3°	-	-	128

PM-905FHC Diagonal Cutting Plier

- Wire spring.

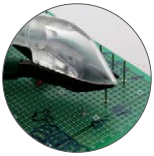

For cutting and control IC pin ends



Connection with tube

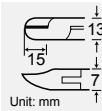

Material	HRC Body	HRC Cutting edge	Hard steel	Soft steel	Copper	OAL (mm)
S55C	41°±4°	60°±2°	Ø 0.8mm	Ø 1.3mm	Ø 2.0mm	128

1PK-706 Long Nose Plier

- Wire spring.
- Serrated tip.

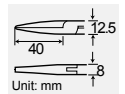

Material	HRC Body	HRC Cutting edge	Hard steel	Soft steel	Copper	OAL (mm)
S45C / PVC	45°±3°	48°±3°	Ø 0.8mm	Ø 1.3mm	Ø 1.6mm	135

1PK-705 Diagonal Cutting Plier

- Wire spring.

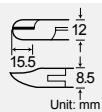

Material	HRC Body	HRC Cutting edge	Soft steel	Copper	OAL (mm)
S55C / PVC	41°±4°	60°±2°	Ø 1.3mm	Ø 2.0mm	128

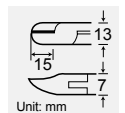
PM-905F Diagonal Cutting Plier

- Wire spring.

Material	HRC Body	HRC Cutting edge	Hard steel	Soft steel	Copper	OAL (mm)
S55C	41°±4°	60°±2°	Ø 0.8mm	Ø 1.3mm	Ø 2.0mm	128

1PK-717 Micro Diagonal Cutting Plier

- Wire spring.

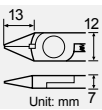

Material	HRC Body	HRC Cutting edge	Soft steel	Copper	OAL (mm)
S55C / PVC	41°±4°	60°±2°	Ø 1.3mm	Ø 2.0mm	124

1PK-036S Long Nose Plier



- Wire spring.
- Serrated tip.

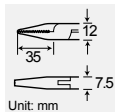

Material	HRC Body	HRC Cutting edge	Hard Steel	Copper	OAL (mm)
S45C	43°±3°	48°±3°	Ø 0.8mm	Ø 1.6mm	136

1PK-046S Needle Nose Plier



- Leaf spring.
- Smooth tip.

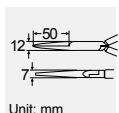

Material	HRC Body	OAL (mm)
S45C	43°±3°	150

PM-712 Extra Long Nose Plier



- Leaf spring.
- Serrated tip.

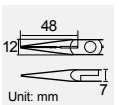

Material	HRC Body	HRC Cutting edge	Hard Steel	Copper	OAL (mm)
AISI 6140	45°±3°	61°±3°	Ø 0.8mm	Ø 2.0mm	155

PM-711 Precision Cutting Plier



- Leaf spring.

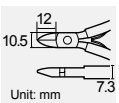

Material	HRC Body	HRC Cutting edge	Copper	OAL (mm)
AISI 6140	45°±3°	61°±3°	Ø 2.0mm	120

1PK-055S Bent Nose Plier



- Wire spring.
- Serrated tip.

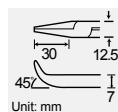

Material	HRC Body	OAL (mm)
S45C	43°±3°	130

1PK-037S Diagonal Cutting Plier



- Wire spring.

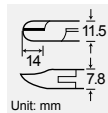

Material	HRC Body	HRC Cutting edge	Hard steel	Soft steel	Copper	OAL (mm)
S45C	43°±3°	48°±3°	Ø 0.8mm	Ø 1.3mm	Ø 1.6mm	110

PM-956 Tungsten Diagonal Cutting Plier 

- Wire spring.

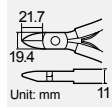

Material	HRC Body	HRC Cutting edge	Piano wire	Soft steel	Copper	OAL (mm)
SAE6140+ Tungsten	45°±3°	72°±2°	Ø0.5mm (under HRC:50°)	Ø 1.6 mm	Ø 2.0 mm	160

PM-955 Tungsten Diagonal Cutting Plier 

- Wire spring.

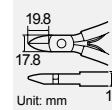
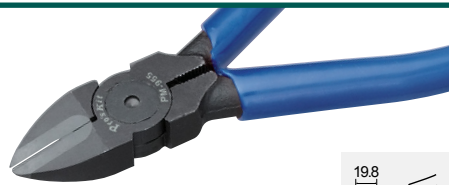

Material	HRC Body	HRC Cutting edge	Piano wire	Soft steel	Copper	OAL (mm)
SAE6140+ Tungsten	45°±3°	72°±2°	Ø0.5mm (under HRC: 50°)	Ø 1.6 mm	Ø 2.0 mm	130

PM-925 Tungsten Diagonal Cutting Plier 

- Wire spring.

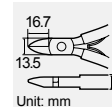

Material	HRC Body	HRC Cutting edge	Piano wire	Soft steel	Copper	OAL (mm)
SAE6140+ Tungsten	45°±3°	72°±2°	Ø0.5mm (under HRC: 50°)	Ø 1.6 mm	Ø 2.0 mm	125

1PK-705Y Side Cutting Plier 

- Wire spring.

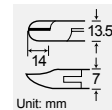

Material	HRC Body	Hard steel	Soft steel	Copper	OAL (mm)
S45C	48°±3°	Ø 0.8mm	Ø 1.6mm	Ø 2.0mm	125

8PK-906 Long Nose Plier 

- Wire spring.
- Serrated tip.

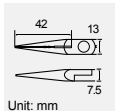

Material	HRC Body	HRC Cutting edge	Application Piano wire	OAL (mm)
SAE 6140	45°±3°	62°±3°	Ø1.2mm (under HRC: 45°)	140

8PK-905 Cutting Plier 

- Wire spring.

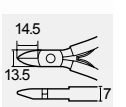

Material	HRC Body	HRC Cutting edge	Application Piano wire	OAL (mm)
SAE 6140	45°±3°	62°±3°	Ø0.5mm (under HRC: 45°)	125

1PK-706Y Long Nose Plier 

- Wire spring.
- Serrated tip.



Material	HRC Body	Hard steel	Soft steel	Copper	OAL (mm)
S55C	45°±3°	Ø 0.8mm	Ø 1.6mm	Ø 2.0mm	160



PM-805E Plastic Cutting Plier



- Wire spring.
- Plastic cutting only.

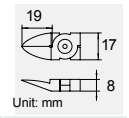

Material	HRC Body	HRC Cutting edge	Application	OAL (mm)
S55C	45°±3°	55°±3°	Plastic	135



PM-806F Plastic Cutting Plier



- Wire spring.

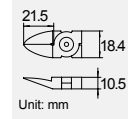

Material	HRC Body	HRC Cutting edge	Soft Steel	Copper	OAL (mm)
S55C / PVC	41°±4°	60°±2°	Ø 1.3mm	Ø 2.0mm	159



PM-806E Plastic Cutting Plier



- Wire spring.
- Plastic cutting only.

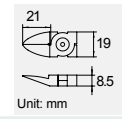

Material	HRC Body	HRC Cutting edge	Application	OAL (mm)
S55C	45°±3°	55°±3°	Plastic	160



PM-805F Plastic Cutting Plier



- Wire spring.

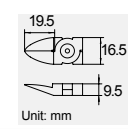

Material	HRC Body	HRC Cutting edge	Soft Steel	Copper	OAL (mm)
S55C / PVC	41°±4°	60°±2°	Ø 1.3mm	Ø 2.0mm	130



PM-807E Plastic Cutting Plier



- Wire spring.
- Plastic cutting only.

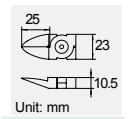

Material	HRC Body	HRC Cutting edge	Application	OAL (mm)
S55C	45°±3°	55°±3°	Plastic	185



PM-806B Plastic End Cutting Plier



- Wire spring.
- 90° vertical small space clipping.

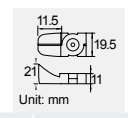

Material	HRC Body	HRC Cutting edge	Hard Steel	Copper	OAL (mm)
S55C	45°±3°	61°±3°	Ø 0.8mm	Ø 2.0mm	150

PM-806A Plastic Oblique Cutting Plier



- Wire spring.
- 45° vertical small space clipping.

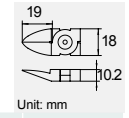

Material	HRC Body	HRC Cutting edge	Hard Steel	Copper	OAL (mm)
S55C	45°±3°	61°±3°	Ø 0.8mm	Ø 2.0mm	150

PK-603 Modeler Basic Craft Tool Set**NEW**

Cutting

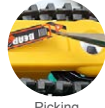

Picking

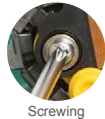

Screwing

- A must-have tool kit for model assembly.
- Right tool just makes everything right.
- Ultra-thin blade design, can cut deep into narrow spaces.

MODEL	CONTENTS
1PK-125T	Super Fine Tip Straight Tweezer (120mm)
9SD-9826-H	SD-9826 Screwdriver Handle
9SB-603	PK-603 Storage Box (133x93.5x28.3mm)
9SD-602-PH1	⊕ #1x75mm Blade bit (4mm)
9SD-602-SL3.0	⊖ 3.0x75mm Blade bit (4mm)
PM-203	Plastic Modeler Side Cutter

PK-605 Modeler Basic Craft Tool Set**NEW**

- Economy type.
- A must-have tool kit for model assembly.
- Right tool just makes everything right!

MODEL	CONTENTS
PA-103	Micro cutting plier
9TZ-501	Straight tip tweezer
SD-5101B	⊕ Line color screwdriver (#0 x 75mm)
9MS-603	Polishing rod
9TZ-502	Curved tip tweezer
SD-5101B	Line color screwdriver (#0 x 75mm)
9SB-1592	Storage Box (145x92x40mm)

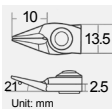
PM-203 Plastic Modeler Side Cutter**NEW**

- Wire spring.

Material	Hardness	Application	OAL (mm)
S50C / TPR	49 \pm 1°	Plastics \leq 0.3mm (PP,PS,PE,ABS)	110

PM-200 Plastic Modeler Side Cutter

- Wire spring.

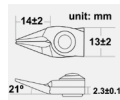

Material	HRC Body	HRC Cutting Edge	Application	OAL (mm)
SK5 / TPR	54 \pm 1°	54 \pm 1°	Plastics \leq 0.3mm (PP,PS,PE,ABS,etc.)	130

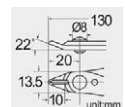
PA-103 Micro Cutting Plier**NEW**

Material	HRC Body	HRC Cutting Edge	Application	OAL (mm)
PVC / 65Mn	50 \pm 3°	50 \pm 3°	Plastics \leq 0.4mm (PP,PS,PE,ABS) Coppers \leq 0.13mm	130

PM-202 Single Blade Model Nipper

- Wire spring.

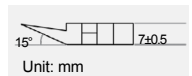
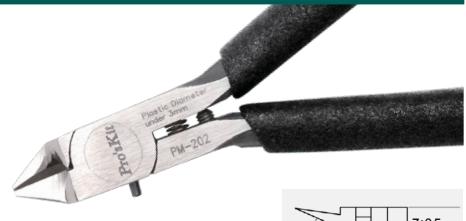

Material	HRC Body	HRC Cutting Edge	Application	OAL (mm)
65CRM / PVC	44 \pm 1°	62 \pm 2°	Plastics \leq 0.3mm (PP,PS,PE,ABS,etc.)	120

ELECTRICAL PLIERS & CUTTERS



CP-420 5 in 1 Long Nose Multi-tool



NEW



- Clamp, Strip, Cut, Crimp, Split.
- Serrated tip.

Material	S55C / PP+TPR
HRC body	48°-58°
Stripping capability	1.3/1.6/2.0/2.6 (mm) AWG 16/14/12/10
Cutting capability	8 AWG/ Ø 8.4mm ² (soft copper)
Side cutter	Ø 2.0mm (hard wire)
Crimper	AWG 22-16 (insulated) / AWG 16-14 (non-insulated)
Splitter	1-4mm ²
OAL (mm)	225

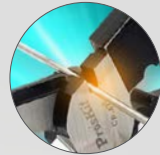

Steel cutter



Powerful twist

1PK-051DS/1PK-052DS/1PK-067DS/1PK-709DS Dual Color Lineman's Pliers



1PK-051DS



1PK-052DS



1PK-067DS



1PK-709DS



1PK-051DS

- Lead free.
- High leverage design.
- Non-slip handle.
- Wire holding.



1PK-052DS



1PK-067DS



1PK-709DS

MODEL	1PK-051DS	1PK-052DS	1PK-067DS	1PK-709DS
Material	55CrNi			
HRC body	45°±3°			
HRC cutting edge	60°±5°			
Hard steel	Ø 2.5mm	Ø 2.0mm		Ø 1.8mm
Soft steel	Ø 3.0mm		Ø 2.4mm	Ø 2.0mm
Copper	Ø 3.2mm			Ø 2.6mm
OAL (mm)	205	162	165	166



1PK-052 Lineman's Plier

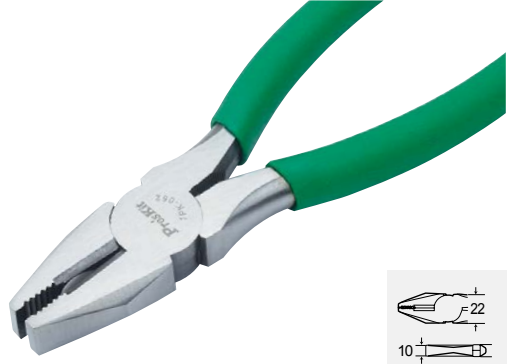

- Lead free.
- Serrated tip.

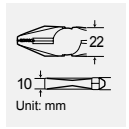

Material	HRC body	Hard steel	Soft steel	Copper	OAL (mm)
S60C	48°±3'	Ø 1.2mm	Ø 2.2mm	Ø3.0mm	165

1PK-067 Side Cutting Plier



- Lead free.

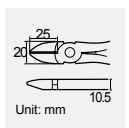

Material	HRC body	Hard steel	Soft steel	Copper	OAL (mm)
S60C	48°±3'	Ø 1.2mm	Ø 2.0mm	Ø 2.6mm	160

1PK-709 Long Nose Plier



- Lead free.
- Serrated tip.

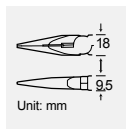

Material	HRC body	Hard steel	Soft steel	Copper	OAL (mm)
S60C	48°±3'	Ø 1.2mm	Ø 2.0mm	Ø 2.6mm	160

PM-708Y Side Cutting Plier

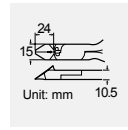

Material	Body	Cutting edge	Copper	OAL (mm)
S55C	45°±3'	55°±5'	Ø 1.6mm	158

1PK-709Y Long Nose Plier Black Oxide Finish



- Serrated tip.
- Use for bending forming and cutting small wires.

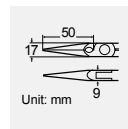

Material	HRC body	Cutting edge	Hard steel	Soft steel	Copper	OAL (mm)
S55C	45°±3'	55°±3'	Ø 1.2mm	Ø 2.0mm	Ø 2.6mm	165

PM-901/PM-903 Lineman's Plier

PM-901

- Serrated tip.
- Quality Cr-V steel.
- High leverage force saving design.



PM-903



SURFACE PHOSPHATE TREATMENT



FORCE-SAVING DESIGN

PM-901

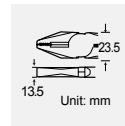

Unit: mm

PM-903

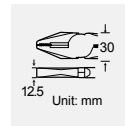

Unit: mm

MODEL	PM-901	PM-903
Material	SAE 6150	
HRC Body	45°±3°	
Cutting edge	60°±2°	
Hard Steel	Piano wire: Ø 2.5mm HRC 45°	
OAL (mm)	215	225

PM-908 Side Cutting Plier Black Oxide Finish 6"

- Leaf spring.
- 2 Skinning notches for stripping insulation wire ø1.5, 2.0mm.

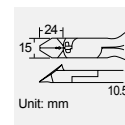

Unit: mm

Material	HRC Body	Cutting edge	Hard steel	OAL (mm)
SAE 6150	45°±3°	60°±2°	Ø 1.4mm	160

PM-909 Long Nose Plier Black Oxide Finish 6"

- Leaf spring.
- Serrated tip.
- Easy gripping in narrow area.

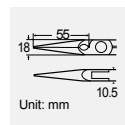

Unit: mm

Material	HRC Body	Cutting edge	Hard steel	OAL (mm)
SAE 6150	45°±3°	60°±2°	Piano wire: Ø 1.2mm	170

PN-378D Adjustable Locking Plier 9"



- Wire spring.
- Serrated tip.
- Lead free.
- Adjustable jaw size allows fixing multi-shape screw, steel plate, etc.

Material	HRC Body	Clamping Round	Clamping Hex	OAL.(mm)
SAE 4140 Cr-Mo alloy steel / SAE 4135 Cr-Mo alloy steel	50°±3°	Ø 8.5~50mm	Ø 8.5~43.3mm	224(9")

PN-378E Long Nose Locking Plier 9"



- Wire spring.
- Serrated tip.
- Lead free.

Material	HRC Body	Clamping Round	Clamping Hex	OAL (mm)
SAE 4140 Cr-Mo alloy steel / SAE 4135 Cr-Mo alloy steel	50°±3°	Ø 7.5~41mm	Ø 7.5~35.41mm	225(9")

SR-015 Nibbling Tool



- Wire spring.

Material	HRC Body	Metal Nibbling	Plastic Nibbling	Replacement blade	OAL (mm)
FCD45 / S45C	45°±3°	0.5-1.2mm	0.5-1.6mm	9SR-015-B	184

PN-P010N Slip-Channel Pump Plier 10"



- Serrated tip.
- Pearl-nickel plated.
- High quality carbon steel drop forged, hardened and tempered.
- Non-slip, plastic coated handle.
- 6 positions adjustable.
- All-purpose jaw grips on round, flat, square, and hex shape.

Material	HRC Body	Handle	Channel adjustment	Max jaw open (A)	Max jaw open (B)	OAL (mm)
S45C	45°±3°	PVC	6 Position	42mm	32mm	254

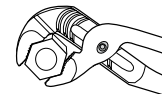

Adjustable jaw to accommodate with hex head screws.

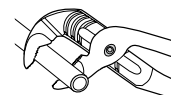

Versatile jaws to fit round tubes.

PN-086N Slip Joint Plier 6"



- Serrated tip.
- Slip joint pliers with wire cutter.
- High quality carbon steel.
- Non-slip, plastic coated handle.

Material	HRC Body	Handle	Channel adjustment	OAL.(mm)
S45C	38°±3°	PVC	2 positions	154

SR-363A/SR-363B**2 in 1 Round Cable Cutter & Stripper****SR-363A****SR-363B**

Cutting round cable

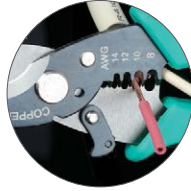

Stripping



- Wire spring.

MODEL	SR-363A	SR-363B
Material	TPR / SK5	
HRC Body	54°±3°	
Stripping	AWG 14-8	AWG 20-10
Cutting	Round cable up to 10.7mm (Ø 0.42")	
OAL (mm)	168	

608-330 Round Cable Cutter

Material	HRC Body	Handle	Cutting	Stranded wire	OAL (mm)
S45C	45°±3°	PVC	multi-conductor cable up to 0.5" (12.7mm)	8 AWG (10mm ²)	165

8PK-CT006 Wire Rope & Cable Armour Cutter

- Lead free.



Material	Handle	Body	Cutting	OAL (mm)
SK5	PVC	60°±4°	wire rope Ø 4mm spring wire Ø 1.5m steel cable: Ø3.2mm	190

8PK-249 Snap Ring Plier Set

- 4 convertible tip jaws for 8 different functions.
- For use on both external and internal.

Material	Handle	HRC Body	Effective range	OAL (mm)
S45C	PVC	43°±3°	10-50mm	155

8PK-A202/8PK-A203/ 8PK-A201A

Forged Cable Cutter



8PK-A202



8PK-A203



8PK-A201A

- High-leverage jaw with shear-cut blades.
- Plastic coated handle.



Easy stripping

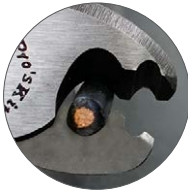

Powerful cutting



270 Degree angle



MODEL	8PK-A202	8PK-A203	8PK-A201A
Material	SCM 440		S45C
HRC body		45°±3'	
HRC cutting edge		60°±5'	
Handle	PVC		
Copper cable	25mm ² flexible	38mm ² flexible	16mm ² solid, 35mm ² stranded, 70mm ² flexible
Aluminum cable	25mm ² stranded	38mm ² stranded	70mm ² stranded
OAL (mm)	160	210	235

6PK-535 Round Cable Cutter



- Ratchet design for force saving.
- Able to cut up to 350 MCM copper, 500 MCM Aluminum core cable, and cord up to Ø32mm or up to 200 pair telecom cable.

REPLACEABLE PARTS

Moving blade : 5PK-535-RB
Fixed blade : 5PK-535-FB



Material	Body	Cutting edge	Handle	Application	OAL (mm)
Low carbon steel / SAE 4340	HR 30N 55°~70°	HRC 45°±3°	PVC	Ø 32mm copper & aluminum cable	254

SR-538 Ratchet Cable Cutter



- Non-slip handle, high force.
- Unique ratchet design.
- Handle lock design.



⚠ Not designed for cutting steel or ACSR

Material	Cutting edge	Handle	Copper	Aluminum	OAL (mm)
S45C / SAE 4340	HRC 46°±2°	P.P	700MCM(350mm ²) Ø 52mm	750MCM(380mm ²) Ø 52mm	335

8PK-SR250/8PK-SR500 Cable Cutter



8PK-SR250



8PK-SR500

- Lead free.



8PK-SR500

8PK-SR250

SCM4 Chromium-Molybdenum steel; efficient and secure in operation

Aluminum handle with non-fracture character

Soft rubber sleeves handle

MODEL	8PK-SR250	8PK-SR500
HRC Blade	52 ^{±2} *	
Copper	DIN 250mm ² , AWG 500	DIN 500mm ² , AWG 1000
Replacement blade	5PK-SR250-BS	5PK-SR500-BS
OAL (mm)	600	800

STRIPPERS



CP-3001D/CP-3002D Precision Wire Stripper With Conductive Handle**CP-3001D****CP-3002D**

- Wire spring.
- Serrated tip.
- Safety lock design
- Multi-functional: Cut, strip & grip.

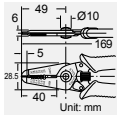

MODEL	CP-3001D	CP-3002D
Material	SK7 / TPR	
HRC	50°±3°	
mm	0.2, 0.3, 0.4, 0.5, 0.6, 0.8	0.8, 1.0, 1.3, 1.6, 2.0, 2.6
AWG	30-20	20-10
OAL (mm)	169	

8PK-3001D/8PK-3002D Precision Wire Stripper**8PK-3001D****8PK-3002D**

- Wire spring.
- Serrated tip.
- Safety lock design

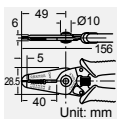

MODEL	8PK-3001D	8PK-3002D
Material	SK7 / PVC	
HRC	50°±3°	
mm	0.2, 0.3, 0.4, 0.5, 0.6, 0.8	0.8, 1.0, 1.3, 1.6, 2.0, 2.6
AWG	30-20	20-10
OAL (mm)	156	

CP-301G/CP-302G Precision Wire Stripper**CP-301G****CP-302G**

- Wire spring.
- Serrated tip.
- Safety lock design

MODEL	CP-301G	CP-302G
Material	S50C / PVC	
HRC	45°±3°	
mm	0.2, 0.3, 0.4, 0.5, 0.6, 0.8	0.8, 1.0, 1.3, 1.6, 2.0, 2.6
AWG	30-20	20-10
OAL (mm)	165	

1PK-3001E/1PK-3002E Precision Wire Stripper With Conductive Handle**1PK-3001E****1PK-3002E**

- Wire spring.
- Serrated tip.
- ESD safe.
- Safety lock design

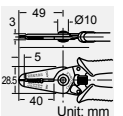

MODEL	1PK-3001E	1PK-3002E
Material	SK7 / TPR	
HRC	50°±3°	
mm	0.2, 0.3, 0.4, 0.5, 0.6, 0.8	0.8, 1.0, 1.3, 1.6, 2.0, 2.6
AWG	30-20	20-10
OAL (mm)	156	

CP-419 Multi Purpose Crimping Tool



- Wire spring.
- 3 in 1 Cutting / Stripping / Crimping.
- Dual cutting edge.
- Insulated & Non-insulated terminals.



Flat edge cutter

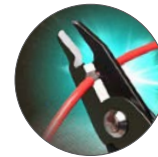

Stripper



Accurate crimp

Material	S50C / TPR
Cutting flat edge	AWG 10-30 (5.5-0.05mm ²)
Cutting beveled edge	AWG 18-30 (0.9-0.05mm ²)
Stripping	AWG 10-28 (5.5-0.08mm ²)
Crimping insulated	1.25-2.0mm ² / 0.3-0.5mm ²
Crimping non-insulated	0.5 / 1.25 / 2.0 / 5.5mm ²
OAL (mm)	185

CP-412G/CP-413G Heavy Duty Wire Stripper/Crimper



CP-412G



- 5 in 1: Clamp, cut, strip, crimp, bolt cut.



Bolt cut

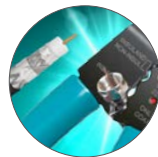

Coax crimp



Accurate crimp



CP-413G



MODEL	CP-412G	CP-413G
Material	S50C / PVC	
HRC	45° ±3°	
Bolt cutting	4-40, 5-40, 6-32, 8-32 10-24, 10-32	4-40, 10-32, 10-24, 8-32 6-32
Stripping standard wire	24-12 AWG	26-10 AWG
Stripping solid wire	22-10 AWG	22-8 AWG
Crimping insulated	22-10 AWG	26-14, 12-10 AWG
Crimping non-insulated	22-10 AWG	
OAL (mm)	206	215

6PK-223 Wire Stripper Cutter

- Wire spring.

Material	HRC	mm	AWG	OAL (mm)
S45C / PVC	45 \pm 3°	0.5-4	30-10	127

CP-108 Wire Stripper Cutter

- Wire spring.
- Lead free.

Material	HRC	mm	AWG	OAL (mm)
S50C / PVC	45 \pm 3°	0.5-4	30-10	127

8PK-CT001 UTP/STP Cable Stripper

Material	Stripping	OAL (mm)
Poly-Resin	UTP/STP cable / 110 Punch down	94

CP-511A Universal Stripper Tool

- Wire spring.

Material	mm ²	AWG	Coaxial cable	OAL (mm)
SK5 / ABS + TPR	0.5/1.0/2.5/4.0/6.0	20-10	RG59/RG6 Ø8-13mm low-volt cable	125

CP-367A Self-Adjusting Insulation Stripper

- Wire spring.
- To adjust length of stripping 8-12mm.
- Fully insulated.
- Cutter under Φ 2.0mm

Material	Nylon / SK5
HRC	55 \pm 3°
mm ²	0.2-6.0
AWG	24-10
OAL (mm)	115

CP-380 Automatic Wire Stripper



Precisely Machined Holes



Fast Compound Wire Stripping Action

- Wire spring.
- For stranded wires.

Material	Hardness	mm ²	AWG	OAL (mm)
Alloy Zinc Steel / SPCC Steel-Plate-ColdRolled-Coil / TPR	HV500-800	JIS 1.25-8	16-8	170

CP-246 Solar Cable Stripper



Adjustable Length Stop



- Wire spring.

Material	HRC	mm ²	AWG	OAL (mm)
Zinc alloy / SK5 / TPR	56 ^{±2}	2.5-6	14-10	177

608-369A/ 608-369B/ 608-369C Wire Stripping Tool



608-369A



608-369B



608-369C



- Wire spring.

MODEL	608-369A	608-369B	608-369C
Material	Zinc alloy / SS 41 / PVC		
Hardness body	HV 450-800		
HRC blade	45°-55°		
mm	0.5, 1.2, 1.6, 2.0	1.0, 1.6, 2.0, 2.6, 3.2	-
AWG	-	-	22-8 (solid wire)
OAL (mm)	170		

CP-369AE/ CP-369BE/ CP-369CE Wire Stripping Tool



CP-369AE



CP-369BE



CP-369CE



- Wire spring.
- Economic type.

MODEL	CP-369AE	CP-369BE	CP-369CE
Material	Zinc alloy / S45C / PVC		
Hardness body	HV 450-800		
HRC blade	45°-55°		
mm	0.5, 1.2, 1.6, 2.0	1.0, 1.6, 2.0, 2.6, 3.2	-
AWG	-	-	22-8 (solid wire)
OAL (mm)	170		

8PK-371DU 9" Automatic Wire Stripper & Crimper



NEW



Adjustable strength

Adjustable length



- Wire spring.
- Universal multifunction - Dual stainless blade, extra sharp & replaceable.

Material	SS41 / Powder Metallurgy / ABS+TPR
HRC body/cutter	53°-57°
HRC stripper	52°-57°
mm ²	0.2-6.0
AWG	24-10 (0.2-6.0mm ²)
Crimping insulated	22-10 AWG (0.5-6.0 mm ²)
Crimping non-insulated	22-10 AWG (0.5-6.0 mm ²)
OAL (mm)	230

8PK-371/8PK-371D Automatic Wire Stripper & Crimper



8PK-371



Stripping

Cutting

Crimping



8PK-371D



- Wire spring.

MODEL	8PK-371	8PK-371D
Material	SS 41 / Powder metallurg / PVC	SS 41 / Powder metallurg / ABS+TPR
HRC cutting edge		55°-60°
HRC blade		52°-57°
mm ²		0.2-6.0
AWG		24-10 (0.2-6.0mm ²)
Crimping insulated		22-10 AWG (0.2-6.0mm ²)
Crimping non-insulated		22-10 AWG (0.2-6.0mm ²)
Auto-ignition Terminal	7-8mm	-
OAL (mm)		210

808-080 Wire Stripping Tool



- Wire spring.
- Ideal for all flat cables.
- Adjustable Knob.
- Inch & Metric Scale.
- Cut & Strip.



Wide stripping jaw design
Easily strip multi-stranded
wire & Dupont wire

Material	HRC blade	mm ²	OAL (mm)
Nylon & low carbon steel / S50C	45°-55°	0.2-4	172

CP-080E Wire Stripping Tool



- Wire spring.
- Ideal for all flat cable
- Adjustable Knob.
- Inch & Metric Scale.
- Cut & Strip.

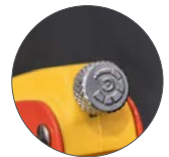

Stripping Size adjustable for
accurately stripping

Material	HRC blade	mm ²	OAL (mm)
Nylon & low carbon steel / 65Mn	45°-55°	0.2-4	172

CP-505

Universal Stripping Tool



Black hook and loop for folding back the braided shield



- Wire spring.
- Replacement cassette: 5CP-505-RG (1pce)
- Replacement blade: 5CP-505-B (4pcs)

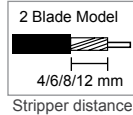

Material	Stripping	Coaxial cable	OAL (mm)
ABS / SK5	UTP/STP, round cable, flat cable	RG-59/11/7/6	125

CP-508

Universal Stripping Tool



- Wire spring.
- Replacement cassette: 5CP-508-RG (1pce)
- Replacement blade: 5CP-508-B (2pcs)

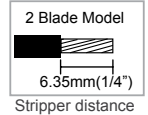

Material	Stripping	Coaxial cable	OAL (mm)
ABS / SK5	UTP/STP	RG-59/6/7/11	135

6PK-501

Wire Stripper Tool



- Wire spring.
- Adjustable blade with strip & cut function.
- Replacement blade: 5PK-376A-BLADE (6pcs)

Material	Stripping	OAL (mm)
ABS / SK5	UTP/STP, round cable ø3.2-9mm	112

CP-512

Rotary Coaxial Cable Stripper



Quick strips
RG59/RG6/RG7/RG11



Black hook for folding back the braided shield

- Wire spring.
- Replacement blade cassette: 5CP-505-RG (1pce)

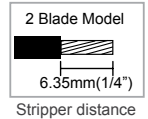

Material	Stripping	OAL (mm)
ABS / SK5	RG-59/6/7/11	94

6PK-332

Rotary Coaxial Cable Stripper



- Wire spring.
- Replacement blade: 5PK-3321 (6pcs)

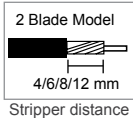

Material	Stripping	OAL (mm)
ABS / SK5	RG-58/59/62/6/3C2V/4C/5C	98.5

6PK-322

Rotary Coaxial Cable Stripper



- Wire spring.
- Adjustable stripping length.

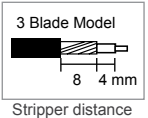

Material	Stripping	OAL (mm)
ABS / SK5	Thinnest RG-58/59/6 coax cable & other cable size	108

8PK-325B/8PK-325/8PK-502**Round Cable Slitting & Ringing Tool****8PK-325B****8PK-325****8PK-502**

- Suitable for cables with different insulation thicknesses.
- V-shape cable holder gives you a good operating experience.



Easy to use



Adjustable blade depth

**8PK-325****8PK-325B****8PK-502**

Adjustable height



Cable slitting and stripping



Strips neatly



Adjustable height

MODEL	8PK-325B	8PK-325	8PK-502
Material	ABS + Fiber glass / SK5 / Metal	ABS + Fiber glass / SK5 / Plastic	Nylon+Fiber / SWP spring steel / Metal
Replacement blade	5PK-325-BL		5PK-502-B
Stripping	from $\varnothing 4.5$ -25mm ($\varnothing 0.18$ "-1.0") diameter	from $\varnothing 4.5$ -25mm ($\varnothing 0.18$ "-1.0") diameter	Single or multiple conductor cable up to $\varnothing 1.75$ " ($\varnothing 44.5$ mm) . Blade can be adjusted for jacket thickness up to 0.125" (3.2mm)
OAL (mm)	150		140

PUNCH DOWN TOOLS

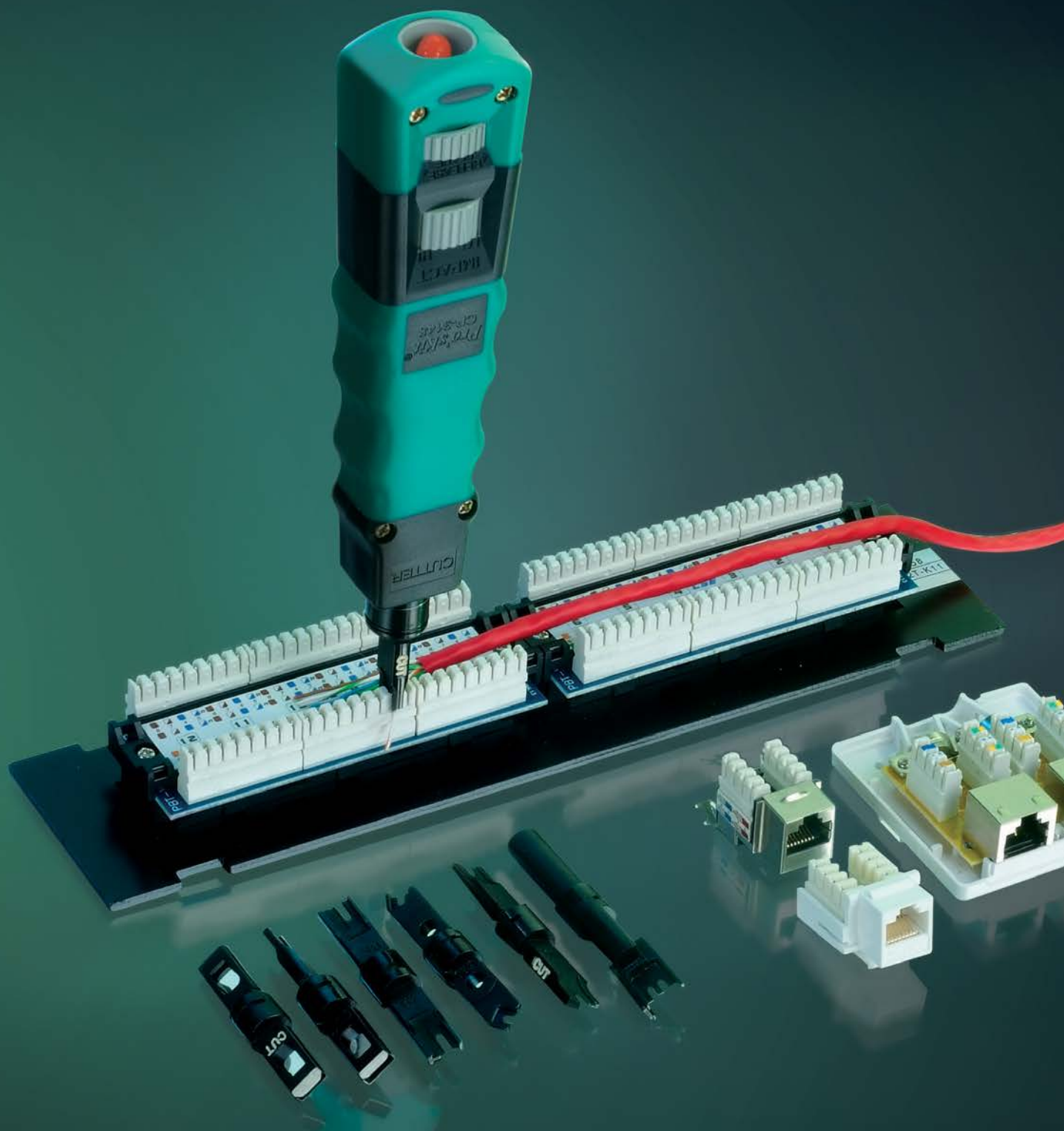

CP-3148 Impact & Punch Down Tool 



Round type

Material	SAE 4140 / ABS + TPR
Impact force setting (Hi)	40lbs/178N
Impact force setting (Low)	30lbs/133N
Standard blade	110/88 & 66(5CP-16A)
OAL.(mm)	162 (w/o blade)

CP-3140 Punch Down Tool with 110 Blades



- Lead free.

Material	SAE 4140 / ABS
Impact force setting (Hi)	15±2kg
Impact force setting (Low)	10±2kg
Standard blade	110/88(5CP-3140-110)
OAL.(mm)	160(w/o blade)

CP-3151/CP-3152 Impact & Punch Down Tool



CP-3151



CP-3152



Round type

- Blade storage design.
- Nonslip handle.
- Replacement blade :
5CP-3152-110 for 110/88 type.
5CP-3152-66 for 66 type.

MODEL	CP-3151	CP-3152
Material	40cr / ABS	
Impact force setting (Hi)	15±2kg	
Impact force setting (Low)	10±2kg	
Standard blade	1pcs 110/88 & 1pcs 66 double end blade with cut function	1pcs 110/88 double end blade with cut function
OAL.(mm)	146	

5CP-16 Series/5PK-3140N-BIX Spare Blades 



5CP-16



5CP-16A



5CP-16B



5CP-16BK



5PK-3140N-BIX



- For CP-3148 punch down tool.

MODEL	5CP-16	5CP-16A	5CP-16B	5CP-16BK	5PK-3140N-BIX
Terminal block	Dual 66 type, one end with cutting function	66, 110/88 type, both ends with cutting function	Dual 110/88 type, one end with cutting function	Dual KRONE 110 type, one end with cutting function	BIX, with cutting function
Blade type	Round				Hex

CP-3141A Krone Impact Terminal Tool with Lock

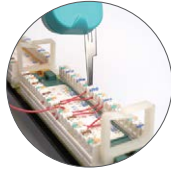

Wire push

Lock for wire push / pull

Lock for cutting



Stop ring

Punch / cut blade
Stop ring design

Wire pull



- Impact, punch, cut.
- Lead free.

Material	Carbon Steel / ABS
Application	For telephone and computer network installation and maintenance. Terminate wire and cuts off excess.
Standard blade	Krone
OAL.(mm)	185

CP-3141 Impact Terminal Tool for Krone



- Lead free.

Material	S45C / ABS
Application	Combination impact and torque tool function. (Both sides with screwdriver & wire-pull functions.)
Standard blade	Krone
OAL.(mm)	175

CP-3145B Punch Down Tool



Rotatable
blade holder



Material	110/88 type: S45C, 66 type: SAE 4140 / ABS
Application	-
Standard blade	66, 110/88 type, both ends with cut function
OAL.(mm)	128





























8PK-324B Impact & Punch Down Tool



Material	SAE 4140 / ABS+Fiber
Application	Impaction function
Standard blade	110/88
OAL.(mm)	114 (w/o blade)

SCREWDRIVER



- | | | | | | | |
|---|--|---|---|--|---|--|
|  Slotted |  Hex |  Triangle |  Wing nut driver |  Square |  Square tamper proof |  Needle type bits |
|  Phillips |  Hex tamper proof |  Spanner nut |  Phillips tamper proof |  Tri-wing |  Microstix |  Torx plus socket |
|  Torx |  Nut |  Spanner |  Clutch |  Ball hex |  Square drive socket |  Pentalobe tip |
|  Torx tamper proof |  Pozidriv |  Torq |  Spline |  Star |  Bihexagon socket |  Tri-point tip |

9SD-2 Series Pro-Soft Screwdriver



- Magnetic.
- Non-slip handle.

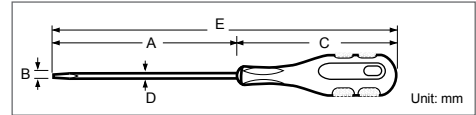

MODEL	A	B	C	D	E
⊕					
9SD-201B	75	#0	88	3.0	163
9SD-202B	75	#1	109	5.0	184
9SD-205B	100	#0	88	3.0	188
9SD-207B	100	#2	121	6.0	221
9SD-210B	100	#1	109	5.0	209
9SD-213B	150	#2	121	6.0	271
9SD-214B	200	#2	121	6.0	321
9SD-216B	150	#1	109	5.0	259
9SD-217B	250	#2	121	6.0	371
9SD-220B	40	#2	58	6.0	98
9SD-222B	150	#3	121	8.0	271
⊖					
9SD-201A	75	3.0	88	3.0	163
9SD-202A	75	5.0	109	5.0	184
9SD-205A	100	3.0	88	3.0	188
9SD-207A	100	6.0	121	6.0	221
9SD-210A	100	5.0	109	5.0	209
9SD-213A	150	6.0	121	6.0	271
9SD-214A	200	6.0	121	6.0	321
9SD-220A	40	6.0	58	6.0	98
9SD-222A	150	8.0	121	8.0	271
⊗					
9SD-200-T05H	50	T5H	88	3.0	159
9SD-200-T06H	50	T6H	88	3.0	159
9SD-200-T07H	50	T7H	88	3.0	159
9SD-200-T08H	50	T8H	88	3.0	159
9SD-200-T09H	50	T9H	88	3.0	159
9SD-200-T10H	75	T10H	88	3.0	184
9SD-200-T15H	75	T15H	88	4.0	184
⊙					
9SD-200-M5	75	M5	110	5.8	185
9SD-200-M6	75	M6	110	7.1	185
9SD-200-I1	75	3/16"	110	5.8	185
9SD-200-I2	75	1/4"	110	7.1	185

SD-2301/SD-2302 Pro-Soft Screwdriver Set



SD-2301



SD-2302



- Magnetic.

SD-2301	SD-2302
⊖ 3.0x75mm	⊗ T5HX50mm
⊖ 5.0x75mm	⊗ T6HX50mm
⊖ 6.0x100mm	⊗ T7HX50mm
⊕ #0x75mm	⊗ T8HX50mm
⊕ #1x75mm	⊗ T9HX50mm
⊕ #2x100mm	⊗ T10HX75mm
-	⊗ T15HX75mm

894 Series/19400-M Series

Pro-Soft Screwdrivers/Electronic Hex Nut Drivers



894 Series 19400-M Series

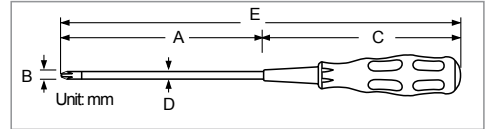

• Magnetic.

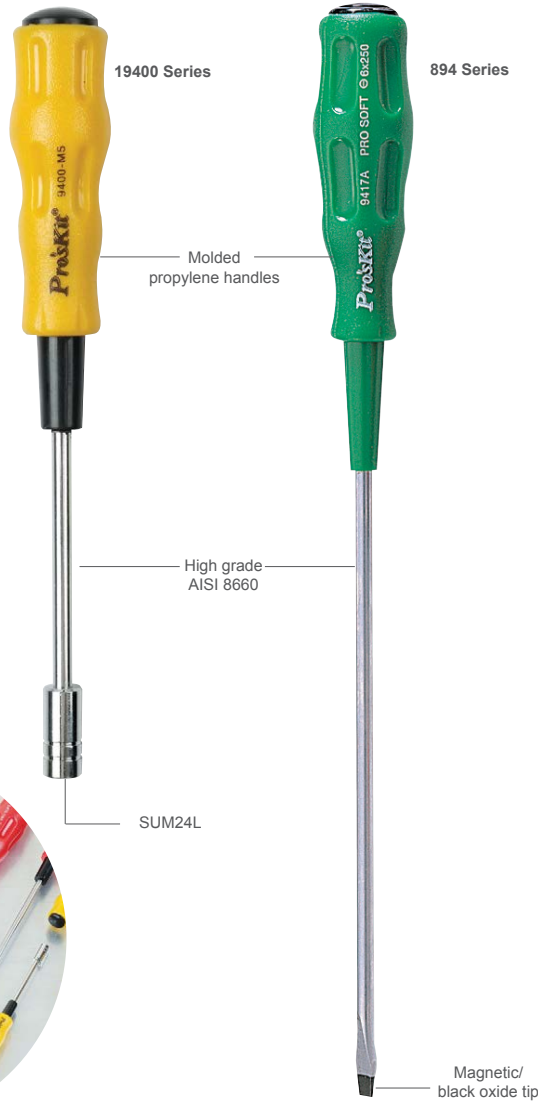

MODEL	A	B	C	D	E
⊖					
89401A	75	3.2	85	3.2	160
89402A	75	5.0	110	5.0	185
89405A	100	3.2	85	3.2	185
89407A-L	57	6.0	153	6.0	210
89410A	100	5.0	110	5.0	210
89413A	107	6.0	153	6.0	260
89416A	150	5.0	110	5.0	260
⊕					
89401B	75	#0	85	3.2	160
89402B	75	#1	110	5.0	185
89405B	100	#0	85	3.2	185
89407B	100	#2	110	6.0	210
89407B-L	57	#2	153	6.0	210
89410B	100	#1	110	5.0	210
89413B	107	#2	153	6.0	260
89414B	157	#2	153	6.0	310
89416B	150	#1	110	5.0	260
89417B	207	#2	153	6.0	360
⦿					
19400-M3	70	3.0	85	4.0	155
19400-M3.5	70	3.5	85	4.0	155
19400-M4	70	4.0	85	4.0	155
19400-M4.5	70	4.5	85	4.0	155
19400-M5	70	5.0	85	4.0	155
19400-M5.5	70	5.5	85	4.0	155
19400-M6	70	6.0	85	4.0	155

1PK-9402 7PCS Electronic Hex Nut Driver Set



CONTENTS
19400-M3
19400-M3.5
19400-M4
19400-M4.5
19400-M5
19400-M5.5
19400-M6

89400 Series Pro-Soft Screwdrivers



Molded propylene handles



Alloy tool steel

Magnetic/black oxide tip

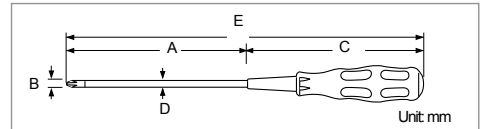

MODEL	A	B	C	D	E
⊕					
89400-T05H	50	T5H	85	4.0	135
89400-T06H	50	T6H	85	4.0	135
89400-T07H	50	T7H	85	4.0	135
89400-T08H	80	T8H	85	4.0	165
89400-T09H	80	T9H	85	4.0	165
89400-T10H	80	T10H	85	4.0	165
89400-T15H	80	T15H	85	4.0	165
●					
89400-H1.5	90	1.5	85	1.5	175
89400-H2	90	2.0	85	2.0	175
89400-H2.5	90	2.5	85	2.5	175
89400-H3	90	3.0	110	3.0	200
⚙					
89400-TRI	50	3.2	85	3.2	135



SW-2125H 5PC Star Screwdriver Set

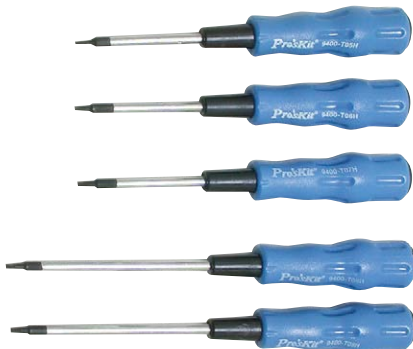

CONTENTS
89400-T05H
89400-T06H
89400-T07H
89400-T08H
89400-T09H

- TOOL KITS
- TEST INSTRUMENTS
- SOLDERING & DESOLDERING
- FIBER OPTICS
- GRIPPERS
- PRECISION PLIERS & CUTTERS
- ELECTRICAL PLIERS & CUTTER
- STRIPPERS
- PUNCH DOWN TOOLS
- ALIGNMENT TOOL & SCREWDRIVERS
- HEX KEY WRENCHES

891 Series/SD-51 Series

High Quality Line Color Screwdriver/ Line Color Screwdriver



891 Series



• Magnetic.



SD-51 Series

- Lead free.
- Magnetic.

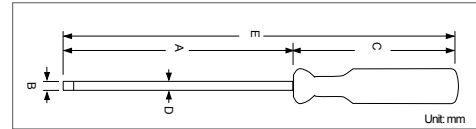
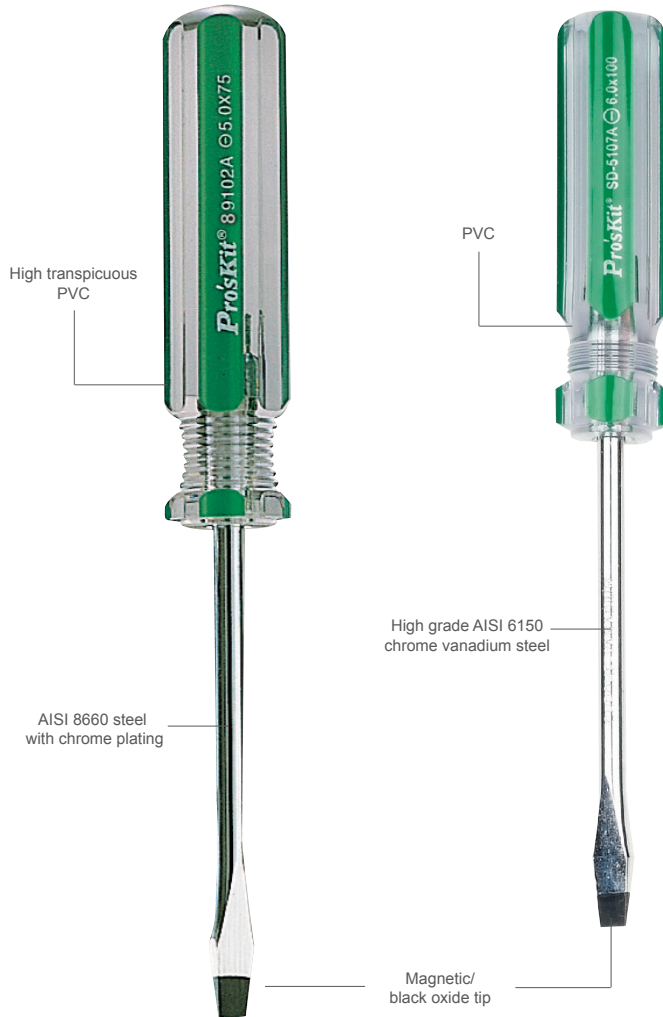

MODEL	A	B	C	D	E
891 Series					
⊖					
89101A	75	3.2	56	3.2	131
89102A	75	5.0	80	5.0	155
89105A	100	3.2	56	3.2	156
89107A	100	6.0	90	6.0	190
89113A	150	6.0	90	6.0	240
⊕					
89101B	75	#0	56	3.2	131
89102B	75	#1	80	5.0	155
89105B	100	#0	56	3.2	156
89107B	100	#2	90	6.0	190
89110B	100	#1	80	5.0	180
89113B	150	#2	90	6.0	240
89115B	200	#1	80	5.0	280
89116B	150	#1	80	5.0	230
89117B	250	#2	90	6.0	340
89120B	38	#2	45	6.0	83
89121B	300	#2	90	6.0	390
SD-51 Series					
⊖					
SD-5101A	75	3.0	57	3.0	132
SD-5102A	75	5.0	80	5.0	155
SD-5105A	100	3.0	57	3.0	157
SD-5106A	150	3.0	57	3.0	207
SD-5107A	100	6.0	90	6.0	190
SD-5110A	100	5.0	80	5.0	180
SD-5113A	150	6.0	90	6.0	240
SD-5116A	150	5.0	80	5.0	230
⊕					
SD-5101B	75	#0	57	3.0	132
SD-5102B	75	#1	80	5.0	155
SD-5105B	100	#0	57	3.0	157
SD-5106B	150	#0	57	3.0	207
SD-5107B	100	#2	90	6.0	190
SD-5110B	100	#1	80	5.0	180
SD-5113B	150	#2	90	6.0	240
SD-5114B	200	#2	90	6.0	290
SD-5116B	150	#1	80	5.0	230
SD-5120B	38	#2	45	6.0	83

SW-9106 Line Screwdriver Set (6PCS)



- Magnetic.



CONTENTS

- ⊖ 89101A
- ⊖ 89102A
- ⊖ 89107A
- ⊕ 89101B
- ⊕ 89102B
- ⊕ 89107B

SD-2800 Series Dual Color Grip Nut Driver

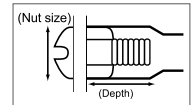
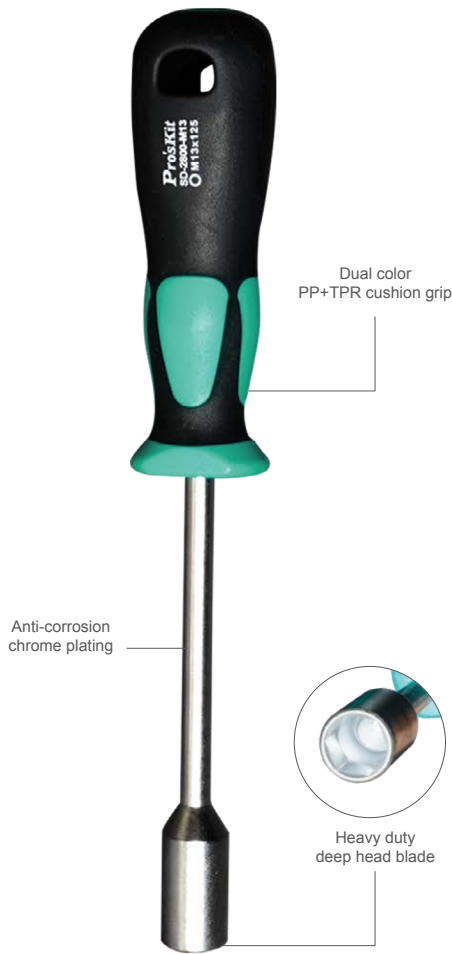

MODEL	Nut size & depth	Blade length	OAL
SD-2800-M5	5 x 25 mm	125 mm	235 mm
SD-2800-M5.5	5.5 x 25 mm	125 mm	235 mm
SD-2800-M7	7 x 25 mm	125 mm	235 mm
SD-2800-M8	8 x 25 mm	125 mm	235 mm
SD-2800-M10	10 x 25 mm	125 mm	235 mm

SD-9821 16 in 1 Ratchet Screwdriver Set

NEW



- 72-tooth fast metal ratchet

CONTENTS	
S45C double end nut driver: Φ 12.8x115mm	
● 1/4" (6.35mm) , 5/16" (8.0mm)	
6150 CrV double end bit: 6.35 x 65mm	
⊕ #1 , #2	⊖ 5mm , 6mm
● T15, T20, T25, T30	● 2.5, 3.0, 4.0, 5.0
6150 CrV double end bit: 8 x 75mm	
⊕ #3	⊖ 8mm
1 PP+TPR handle / Φ 38x148mm	

TOOL KITS

TEST INSTRUMENTS

SOLDERING & DESOLDERING

FIBER OPTICS

GRIPPERS

PRECISION PLIERS & CUTTERS

ELECTRICAL PLIERS & CUTTER

STRIPPERS

PUNCH DOWN TOOLS

ALIGNMENT TOOL & SCREWDRIVERS

HEX KEY WRENCHES

SD-9857M 57 in 1 Driver Kit

- Quick release chuck.

CONTENTS

24pcs / Ø 1/4" (6.35mm) / Cr-V	30pcs / Ø 4mm / Cr-V
⊖ 4, 5, 6, 7mm	⊕ #00, #0, #1, #2
⊕ #0, #1, #2, #3	⊖ 1.5, 2, 2.5, 3, 3.5, 4mm
● 3, 4, 5, 6mm	● T4, T5, T6, T7, T8, T10, T15, T20
● T25, T27, T30, T40	● 0.9, 1.3, 1.5, 2, 2.5, 3mm
⊕ PZ0, PZ1, PZ2, PZ3	● 1.0
⊖ 2.6mm ⊖ Y0	● 3.0 ⊖ 2.6mm
● S1, S2	● Y3.0 ● P2, P5
1/4" Extension bar / 100mm	
1/4" to 4.0mm adapter	

1PK-201 Flexible Ratchet Driver Set**CONTENTS**

10pcs / Ø 1/4" (6.35mm) x 30mm / AISI 6150 Cr-V	
⊖ 4, 5, 6mm	⊕ PZ1, PZ2
⊕ #1, #2	● T10, T15, T20
Flexible shaft / 190mm	
Mini ratchet handle	

SD-9816 16-In-1 Reversible Ratchet Precision Screwdriver Set

- Click-stop ball clamp.
- Reversible blades.
- Flexible & adjustable blade length.
- Hex retainer design.

CONTENTS

8pcs / Ø 1/4" (6.35mm) x 175mm / S2 Alloy steel	
⊖ 4, 5mm	⊖ HB5.0, HB6.0
⊖ 6, 7mm	⊕ #1
● T20, T30	⊕ #2
● T25, T40	⊕ PZ1
● H5.0, H6.0	⊕ PZ2
3 position ratchet handle / 155mm	

SD-9820 10 in 1 Ratchet Screwdriver Kit

- Magnetic.
- Chrome vanadium steel.
- Non-slip soft grip handle.
- 42*Adjustable Ratchet

CONTENTS

2pcs/Ø6.35mm x 65mm	2pcs/Ø 6.35mm x 110mm	2pcs/Ø 6.35mm x 126mm
⊕ ⊖ #1, 5mm	⊕ ⊖ #1, 5mm	⊕ #0
⊕ ⊖ #2, 6mm	⊕ ⊖ #2, 6mm	⊖ 3mm
Blade Material: Cr-V 6150 / HRC: 52°		
1 PP+TPR handle / Ø43x105mm		

SW-9107D Double End Reversible Screwdriver



- Magnetic.

Material	HRC	Handle	Blade	Working length
AISI 6150	52°±2°	95mm	126mm	100mm

SD-5107D Double End Reversible Screwdriver



- Magnetic.

Material	HRC	Handle	Blade	Working length
AISI 6150	48°±3°	108mm	125mm	100mm

SW-9109D 10 In 1 Double End Reversible Screwdriver Set



- Magnetic.

CONTENTS		
6pcs / Ø6.35mm / AISI 6150 Cr-V / HRC: 52°±2°		
⊕ ⊖ #2, 6.0 / 110mm	⊕ #2, #2 / 65mm	⊕ #1 / 100mm
⊕ #2, #2 / 110mm	⊕ #2 / 100mm	⊕ #2, #2 / 150mm
1 PVC handle / 100mm		

SD-2320M 18 in 1 Mini T-handle Ratchet Set



CONTENTS		
9pcs / 1/4" (6.35mm) bits / Cr-V		
⊖ 3,5,6mm	⊕ #1,#2,#3	⊙ T10,T15,T20
6pcs / 1/4" (6.35mm) drive sockets / carbon steel		
● 5,6,7,8,9,10mm		
1 T handle ratchet driver	1 extension bar	1 adapter

8PK-SD009/E 33PCS Security Bit kit



8PK-SD009



8PK-SD009E

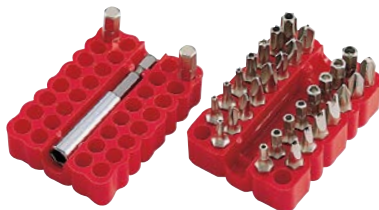

CONTENTS	
32pcs / Ø 1/4"x30mm / S2 alloy steel (8PK-SD009) ; SAE 6150Cr-V (8PK-SD009E)	
● 5/64", 3/32", 7/64", 1/8", 9/64", 5/32", 3/16", 1/4"	⊖ 4, 6, 8, 10
● T8H, T10H, T15H, T20H, T25H, T27H, T30H, T35H, T40H	⊕ #1, #2, #3, #4
● 1, 2, 3, 4	⊕ 6, 8, 10
Ø 1/4" magnetic extension bar / 60mm	

SD-9701M 20 in 1 T-handle Driver Sockets & Bits Set

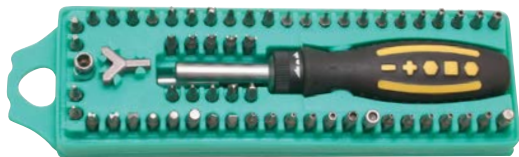

CONTENTS		
10pcs/ hex bits Ø1/4"x25mm / SAE 6150Cr-V		9pcs Ø1/4" sockets
⊖ 4, 5mm	⊕ #1, #2	● 5,6,7,8,9,10,11,12,13 mm(3/16", 1/4", 9/32", 5/16", 11/32", 3/8", 7/16", 1/2", 9/16")
● T15, T20	⊕ PZ1, PZ2	
● 4, 5mm		
1 PP+TPR holder /182mm	1 adapter / 65mm	1 case / 115x55x17mm

SD-205 62 PCS Security Bit Set

- Ratchet design.

CONTENTS

58pcs / Ø 1/4" (6.35mm) x 25mm bits/ SAE8660 Cr-V		
● M5, M6, M8	● C1, C2, C3	● 1/8", 3/16"
● 2mm x 2mm x 2mm	● S0, S1, S2, S3	● 1, 2, 3, 4, 5
● #0, #1, #2	● Wing nut driver	● 6, 8, 10
● PZ0, PZ1, PZ2	● 4, 6, 8, 10, 12	
● T5H, T6H, T7H, T8H, T9H, T10H, T15H, T20H, T25H, T27H, T30H, T40H		
● 2mm, 2.5mm, 3mm, 4mm, 5mm, 6mm, 8mm, 5/64", 3/32", 7/64", 1/8", 9/64", 5/32"		
1 magnetic bit holder / 60mm	1 socket holder	1 socket adapter
1 TPR ratchet handle / 190mm		1 case / 256x80x43mm

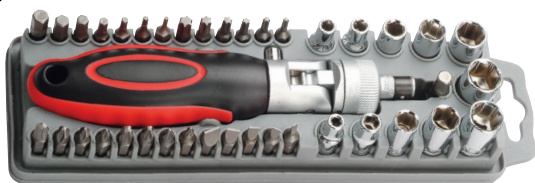
SD-2309 40 PCS Reversible Ratchet Screwdriver W/Bits & Sockets Set

- Adjusting angle up to 180 degree.

CONTENTS

26pcs / Ø 1/4" (6.35mm) x 25mm bits/ SAE8660 Cr-V		
● #0, #1, #2, #3	● 3, 4, 5, 6, 8mm	
● PZ0, PZ1, PZ2, PZ3	● T10, T15, T20, T25, T30, T40	
● 2, 2.5, 3, 4, 5, 6, 7mm		
11pcs / Ø 1/4" sockets		
● 4, 5, 5.5, 6, 7, 8, 9, 10, 11, 12, 13mm		
1 magnetic bit holder / 100mm	1 adapter	
1 ratchet handle	1 case / 228x72x45mm	

SD-2310 100 PCS Assorted Power Bit Set**CONTENTS**

96pcs / Ø 1/4" (6.35mm) x 25mm bits/ SAE8660 Cr-V		
● #1, #2	● #0, #1, #2, #3	● PZ0, PZ1, PZ2, PZ3
● C1, C2, C3	● S0, S1, S2, S3	● M5, M6, M8
● 1, 2, 3, 4, 5	● 6, 8, 10	● 4, 6, 8, 10, 12
● 2mm x 2mm x 2mm	● 2, 3, 5mm	● Wing nut driver
● 1.5mm, 2mm, 2.5mm, 3mm, 4mm, 4.5mm, 5mm, 5.5mm, 6mm, 7mm, 8mm 1/16", 5/64", 3/32", 7/64", 1/8", 9/64", 5/32", 3/16", 7/32", 1/4"		
● 2mm, 3mm, 4mm, 5mm, 6mm, 7mm, 8mm 5/64", 3/32", 7/64", 1/8", 9/64", 5/32", 3/16", 7/32", 1/4"		
● T5H, T6H, T8H, T10H, T15H, T20H, T25H, T27H, T30H, T35H, T40H		
● T5, T6, T8, T10, T15, T20, T25, T27, T30, T40		
1 magnetic bit holder	1 bit holder	1 socket adapter
1 dry wall stopper		1 case / 212x64x31mm

1PK-202A / 1PK-202B 17 PCS Offset Ratchet & Socket Drivers Set**1PK-202A****1PK-202B**

- Lead free.

1PK-202A 2-way ratchet handle

1PK-202A 2-way ratchet handle	1PK-202B 2-way ratchet handle
1/4" sockets(6pcs)	1/4" sockets(6pcs)
● 5, 6, 7, 8, 9, 10mm	● 3/8", 11/32", 5/16", 1/4", 7/32", 3/16"
1/4" bits (10pcs)	1/4" bits (10pcs)
● 4, 5, 6mm	● 4, 5, 6mm
● #1, #2	● #1, #2
● PZ1, PZ2	● PZ1, PZ2
● T10, T15, T20	● T10, T15, T20



SD-083 Series ESD Precision Screwdriver

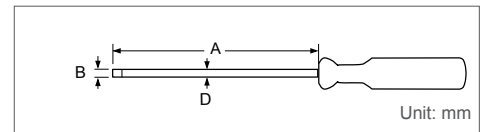
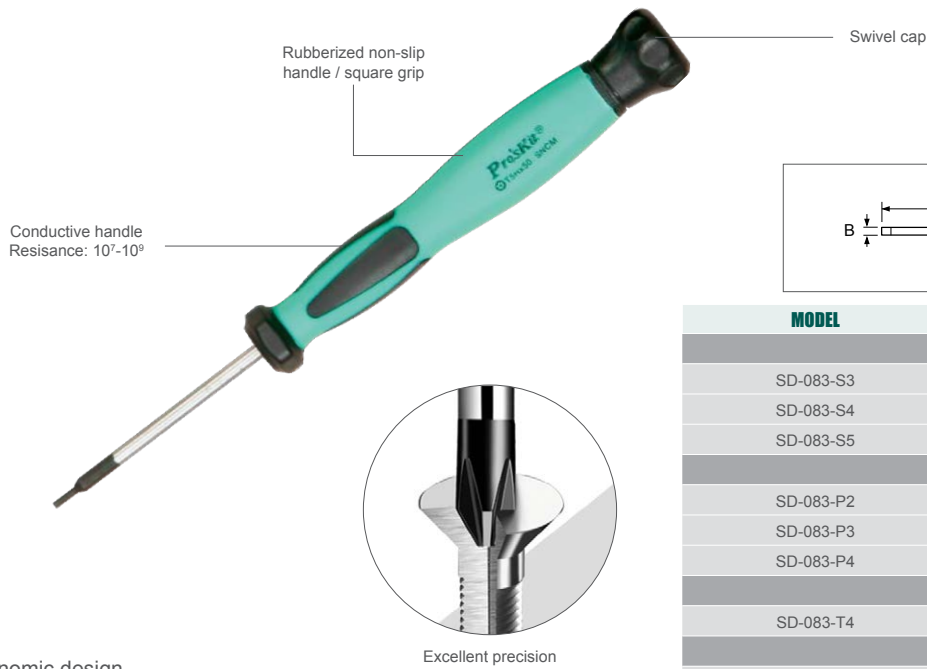

MODEL	A	B	D
-			
SD-083-S3	50	2.0	2.0
SD-083-S4	50	2.4	2.4
SD-083-S5	50	3.0	3.0
+			
SD-083-P2	50	#00	2.0
SD-083-P3	50	#0	2.4
SD-083-P4	50	#1	3.0
T			
SD-083-T4	50	T4	3.0
H			
SD-083-T5H	50	T5H	3.0
SD-083-T6H	50	T6H	3.0

- Ergonomic design.
- ESD-Safe.

SD-0839 ESD Precision Screwdriver Set



CONTENTS	
⊖ SD-083-S3	⊕ SD-083-P2
⊖ SD-083-S4	⊕ SD-083-P3
⊖ SD-083-S5	⊕ SD-083-P4
⊙ SD-083-T4	⊙ SD-083-T5H
⊙ SD-083-T6H	

SD-081 /SD-2400 Series Precision Screwdriver/Nut Driver



SD-081



SD-2400

- SD-081 designed for Apple products.

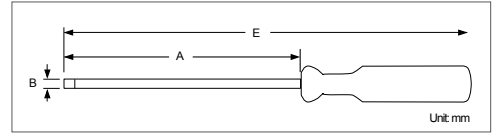
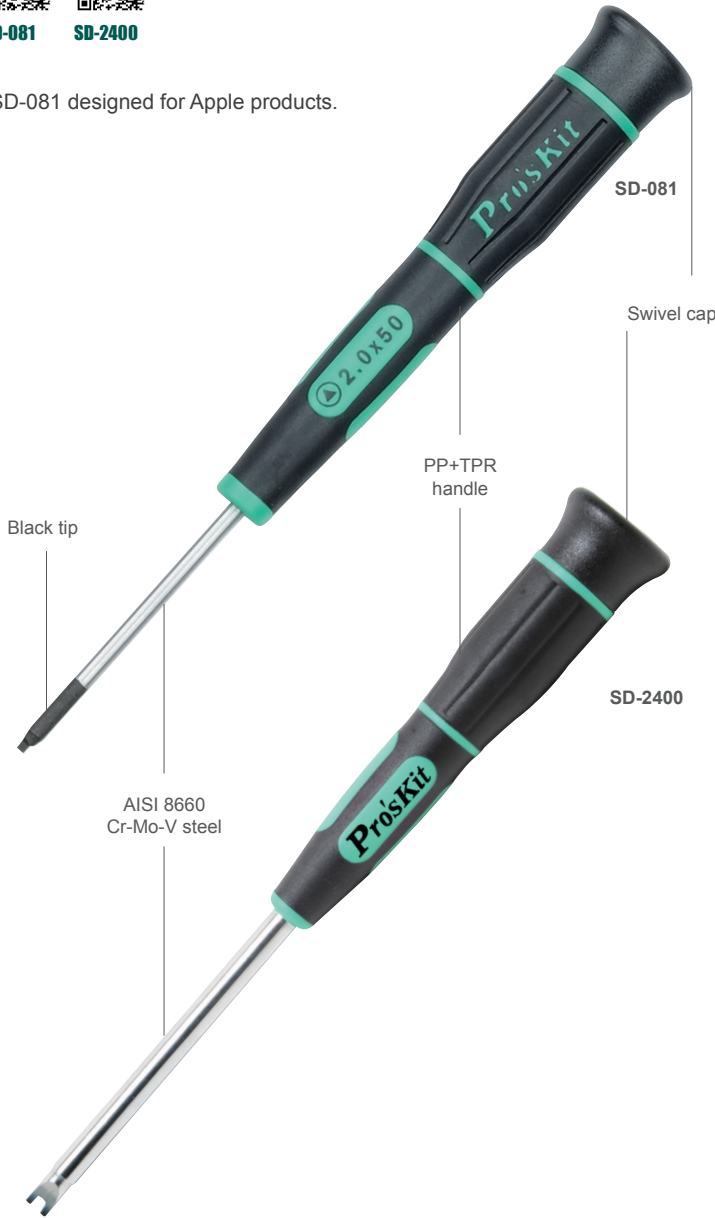

MODEL	B	A	MODEL	B	A
⊖			⊕ S2 steel		
SD-081-S1	1.0	50	SD-081-T2	T2	50
SD-081-S2	1.6	50	SD-081-T3	T3	50
SD-081-S3	2.0	50	SD-081-T4	T4	50
SD-081-S4	2.4	50	SD-081-T5	T5	50
SD-081-S5	3.0	50	SD-081-T6	T6	50
SD-081-S6	2.4	75	SD-081-T7	T7	50
SD-081-S7	3.0	100	SD-081-T8	T8	50
SD-081-S8	4.0	150	SD-081-T10	T10	50
⊕			⊕ S2 steel		
SD-081-P1	#000	50	SD-081-T5H	T5H	50
SD-081-P2	#00	50	SD-081-T6H	T6H	50
SD-081-P3	#0	50	SD-081-T7H	T7H	50
SD-081-P4	#1	50	SD-081-T8H	T8H	50
SD-081-P5	#0	75	SD-081-T9H	T9H	50
SD-081-P6	#1	100	SD-081-T10H	T10H	50
SD-081-P7	#1	150	SD-081-T15H	T15H	50
			SD-081-T20H	T20H	50
SD-081-TA20	2.0	50	⊖		
SD-081-TA23	2.3	50	SD-081-H2	0.9	50
SD-081-TA27	2.7	50	SD-081-H3	1.3	50
			SD-081-H4	1.5	50
SD-081-TRI000	#000	50	SD-081-H5	2.0	50
SD-081-TRI00	#00	50	⊕		
SD-081-TRI0	#0	50	SD-081-TS1	P2	50
SD-081-TRI1	#1	50	SD-081-PL5	P5	50
			⊕		
SD-081-TRIY06	TRIY06	50	SD-081-M5.5	M5.5	72

MODEL	B	E
⊖		
SD-2400-S4	1.5	186
SD-2400-S6	2.3	186
SD-2400-S8	2.5	186
SD-2400-S10	3.1	186

SD-081F/G Precision Screwdriver Set



SD-081F



SD-081G



CONTENTS	SD-081F	SD-081G
Head type	⊕ 2.0, 2.3, 2.7	⊕ #000, #00, #0, #1
Material	AISI 8660 Cr-Mo-V steel / TPR handle	
OAL.(mm)	147mm	

SD-2404 4PCS Security Screwdriver Set



CONTENTS	CONTENTS
Head type	⊖ 1.5, 2.3, 2.5, 3.1
Material	AISI 8660 Cr-Mo-V steel / TPR handle
OAL.(mm)	186mm

SD-9803 33 PCS Screwdriver Set w/Bits



CONTENTS

30pcs / Ø4 x 28mm hex bits / AISI 8660 Cr-Mo-V

- ⊕ #000, #00, #0, #1 ⊕ PZ1, PZ0
- ⊖ SL1.0, SL1.5, SL2.0, SL2.5, SL3.0, SL3.5, SL4.0
- ⊙ T4, T5, T6, T7, T8, T9, T10, T15, T20
- H0.7, H0.9, H1.3, H1.5, H2.0, H2.5, H3.0, H4.0

2pcs / Ø4mm sockets / AISI 6150 Cr-V

- M5, M6

1 TPR handle with bits holder

1 case / 170x139x23mm

Adjustable length 36-125mm

SD-081A 7 PCS Electronic Screwdriver Set



- SD-081 series.

CONTENTS

7pcs / AISI 8660 Cr-Mo-V steel

- ⊕ #00, #0, #1
- ⊖ 1.6, 2, 2.4, 3mm

TPR handle / 147mm

1 case / 170x139x23mm

SD-9824 24 in 1 Screwdriver Set



- Adjustable Blade Length 28-129mm.

CONTENTS

12pcs / Ø4 x 160mm hex bits / AISI 8660 Cr-Mo-V

- ⊕ #000, #00, #0, #1 ⊖ 1.5, 2, 3, 4mm
- ⊕ PZ0, PZ1
- ⊙ T5H, T6H, T7H, T8H, T9H, 10H, T15H, T20H
- H1.5, H2.0, H2.5, H3.0, H3.5, H4.0

1 ratchet handle / 130mm

1 case / 192x130x26mm

SD-081H 7 PCS Electronic Repair Set



- SD-081 series.
- For Apple Products.

CONTENTS

7pcs / AISI 8660 Cr-Mo-V steel

- ⊕ #000, #00, #0 ⊖ 2.0, 2.4mm
- ⊙ TRIY06 ● TS1

TPR handle / 147mm

1 case / 170x139x23mm

TOOL KITS

TEST INSTRUMENTS

SOLDERING & DESOLDERING

FIBER OPTICS

GRIPPERS

PRECISION PLIERS & CUTTERS

ELECTRICAL PLIERS & CUTTER

STRIPPERS

PUNCH DOWN TOOLS

ALIGNMENT TOOL & SCREWDRIVERS

HEX KEY WRENCHES

SD-9827M Precision Repair Tools Set

- Magnetic.
- Fits screws perfectly.
- Fine tip tweezers.

CONTENTS

15pcs / 4 x 28mm bits / Cr-V	
⊕ 1.2, 2, 2.5, 3mm	⊕ #00, #0, #0, #1, #2
⊖ T5, T6, T7, T8, T10	⊖ 2.6
4pcs / 40 Cr alloy steel sockets	4pcs / 60 carbon steel wrenches
⊕ M2.5, M3, M4, M5	M4, M4.5, M5, M6
1 magnetizer / demagnetizer	
1 tweezer / 144x9.5mm	1 magnetic extension bar / 75mm
1 ratchet handle / 122x19mm	1 case / 172x122x34mm

SD-9826 33 in 1 Precision Electronic Screwdriver Set

- Magnetic.

CONTENTS

30pcs / Ø4 x 28mm bits / Cr-V 6150	
⊕ #00, #0, #1, #2	⊖ 2.6
⊖ 1.5, 2, 2.5, 3, 3.5, 4mm	⊖ 2.0
⊕ 1.0	⊖ Y3.0
⊖ 0.9 / 1.3 / 1.5 / 2.0 / 2.5 / 3.0 / 4.0	⊖ 3.0
⊖ T4 / T5 / T6 / T7 / T8 / T10 / T15 / T20	
1 tweezer / 114mm	1 extension bar / 60mm
1 PP+TRP handle / 105mm	1 case / 155x105x30mm

SD-9802 31 in 1 Precision Electronic Screwdriver Set

- Swiveling cap.
- Keyless chuck.
- Adjustable bit holder.

CONTENTS

30pcs / Ø4 x 28mm bits / S2 steel	
⊕ #00, #0, #1, #2	⊖ 2.6
⊖ 1.5, 2, 2.5, 3, 3.5, 4mm	⊖ 2.0
⊕ 1.0	⊖ Y3.0
⊖ 0.9 / 1.3 / 1.5 / 2.0 / 2.5 / 3.0 / 4.0	⊖ 3.0
⊖ T4 / T5 / T6 / T7 / T8 / T10 / T15 / T20	⊖ Pin 1.0mm
-	1 extension bar / 115mm
1 PP+TRP handle / 115mm	1 case / 115x105x30mm

SD-9804**15 in 1 Precision Electronic Screwdriver Set****CONTENTS**

14pcs / 4 x 28mm bits / 6150 Cr-V

⊕ #000, #00, #0, #1	⊖ 1.5, 2, 2.5, 3, 4mm	⊙ T5, T6, T7, T8, T9
1 PP+TRP handle/110mm	1 extension bar / 110mm	1 case / 147x95x24mm

SD-9814**9 in 1 Aluminum Handle Precision Screwdriver Set**

Bits Storage

CONTENTS

9pcs / 4 x 28mm bits / 6150 Cr-V

⊕ #000, #00, #0, #1	⊖ 2, 3mm	⊙ T4, T5, T6
1 aluminum handle/110mm		

SD-9608**30 PCS Aluminum Handle Precision Screwdriver Set****CONTENTS**

28pcs / 4mm bits / S45C steel

⊕ #000, #00, #0, #1	⊖ 1, 1.2, 1.5, 1.8mm	⊕ PZ000, PZ00, PZ0, PZ1
⊙ 0.7, 0.9, 1.3, 1.5, 2	⊙ T4, T5, T6, T7	⊙ P2
⊙ S0	⊙ 1.0	⊙ 2.0
	⊙ 2.6	⊙ Y3.0
		⊙ 3.0

1 aluminum handle / 113mm

1 case / 148x74x28mm

1 extension bar / 4x70mm

SD-9815**Precision Screwdriver Set**

- Carrying case doubles as a stand to hold the tools during use.
- Transparent cover with magnifying glass effect.

**CONTENTS**

6pcs / S45C steel

⊕ #0x96mm, #1x109mm	⊖ 1.4x79, 1.8x89, 2.4x96, 3.0x109mm
Nickel Plated handle	1 case / 135x94x22mm

8PK-SD002N**8 PCS Screwdriver Set****CONTENTS**

8pcs / 8660 Cr-V

⊕ #00, #0, #1	⊖ 2, 2.5, 3, 3.5, 4mm
TPR handle / 103mm	1 case / 205x127x34mm
Blade length / 60mm	OAL / 163mm

TOOL KITS

TEST INSTRUMENTS

SOLDERING & DESOLDERING

FIBER OPTICS

GRIPPERS

PRECISION PLIERS & CUTTERS

ELECTRICAL PLIERS & CUTTER

STRIPPERS

PUNCH DOWN TOOLS

ALIGNMENT TOOL & SCREWDRIVERS

HEX KEY WRENCHES

SD-3502 6 PCS Star Screwdriver Set



CONTENTS

- 6pcs / 8660 Cr-V / 20mm
- T4
- T5H, T6H, T7H, T8H, T9H
- 1 ABS handle / 90mm
- 1 case / 121x93x19mm

8PK-2061 6 PCS Electronic Screwdriver Set



CONTENTS

- 6pcs / 8660 Cr-V / 20mm
- #00, #0, #1
- 1.4, 1.8, 2.4mm
- 1 ABS handle / 90mm
- 1 case / 121x93x19mm

8PK-2062 6 PCS Electronic Screwdriver Set



CONTENTS

- 6pcs / 8660 Cr-V / 20mm
- 1.4, 1.6, 1.8, 2, 2.4, 3mm
- 1 ABS handle / 90mm
- 1 case / 121x93x19mm

8PK-2063 5 PCS Electronic Screwdriver Set



CONTENTS

- 6pcs / 8660 Cr-V / 20mm
- #0-4, #0-3, #00, #0, #1
- 1 ABS handle / 90mm
- 1 case / 121x93x19mm

SD-803 4 in 1 Screwdriver Set



CONTENTS

- 50pcs / ABS+6150 Cr-V / 131mm
- 1/16", 1/8"
- #00, #0
- 1 Display box / 213x123x144mm

- Lead free.
- Two double-ended, reversible tips.
- HRC: 52°±3°.

1PK-034 Series Ceramic Driver

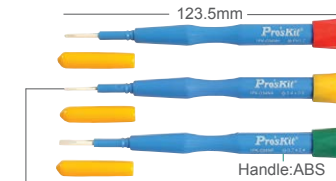

Bit: Zirconia

MODEL	CONTENT
1PK-034NA	0.4x0.9mm
1PK-034NB	0.3x1.2mm
1PK-034NC	0.4x1.8mm
1PK-034ND	0.4x2.0mm
1PK-034NE	0.4x2.4mm
1PK-034NF	0.7x2.4mm
1PK-034NG	#0
1PK-034NH	#1.7

908-607 4 in 1 Screwdriver Set



CONTENTS

- Tip: Stainless
- Body: K-glass
- Handle: PE
- 2.0mm
- OAL: 200mm

- Ideal for handyman and TV technicians.

1PK-A001 10 PCS Trimming Tool Set

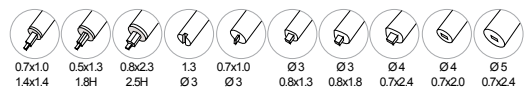

CONTENTS

- 10pcs / PC / 115mm
- Spec as sketch

SD-9322M

Precision Repair Screwdriver Set



- Ideal for 3C maintenance, such as iPhone 6/7/8/X, Samsung, Mi, Oppo, Vivo, Huawei, and more.
- 24 PCS selected bits with essential helping tools.



CONTENTS

24pcs / Ø4 x 28mm bits / Cr-V 6150

⊕ #000, #00, #0, #1	⊕ 2.5
⊖ 1.0mm	⊖ Y00, Y0
● T2, T3, T4, T5, T6	● Y06
● 1.5, 2.0	● 3.0
● T8H, T10H	● 2.5
● 0.8(P2) x 2, 1.2(P5), 1.5(P6)	
1 tweezer	1 extension bar / 75mm
1 suction cup	1 SIM card tray opener 0.8mm
1 prying paddle / 35mm	2 opening lever / 75mm & 80mm
1 case / 200x115x29mm	

1PK-3179

5 PCS Spudger/ Prying Tool Assortment



- Ideal for most brands of smart phones, video games, notebooks, electronic devices.
- Opening and prying disconnecting small electronic components without damaging housing or parts.



CONTENTS

- 1 pce Double-ended metal spudger OAL:185mm
- 1 pce Nylon aid tool, OAL:150mm
- 2 pcs Polyoxymethylene (POM) opening levers, OAL:84.4mm, 88.7mm
- 1 pce Prying paddle, 30.5x30.5x30.5mm

MS-3176

4 PCS Open Repair Tool Set



- Ideal for most brands of smart phones, video games, notebooks, electronic devices.
- Opening and prying disconnecting small electronic components without damaging housing or parts.

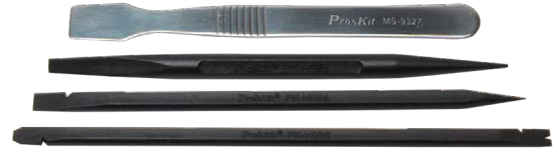

CONTENTS

- Metal spudger tool (123 mm)
- Point-blade solder aid tools (155 mm)
- Spudger solder aid tools (140 mm)
- Fork-blade solder aid tools (173 mm)

SD-9314

17 in 1 Tool Kit For Apple Products



CONTENTS

12pcs / Ø4 x 28mm bits / Cr-V 8660

- | | |
|---------------------------------------|-----------------------------------|
| ⊕ #000 | ● P2 |
| ⊖ 1.5mm | ● 1.0 |
| ● T4, T5, T6, T8, T10, T15, T20 | ● H2.0mm, H1.5mm |
| 1 dual color handle / 110mm | 2 opening lever / 84.4mm & 88.7mm |
| 1 suction cup Ø36mm / 1 prying paddle | 1 case / 151x103x30mm |

PK-9110

6 PCS iPhone Series Disassemble Set



CONTENTS

- P2X40mm : OAL 91.5mm
- ⊕ #000X40mm : OAL 91.5mm
- Polyoxymethylene (POM) opening lever x 2 OAL: 84.4mm, 88.7mm
- Suction cup Ø36mm
- Prying paddle 30.5mm x 30.5mm x 30.5mm

SD-9828 58 PCS Driver Kit



- P2 / P5 / P6 Pentalobe tips are designed for Apple products.
- TS3.8 / TS4.5 Torxplus® are designed for Nintendo, Microsoft products.

CONTENTS

42 pcs Ø4.0×28 mm, material : S2 steel		
⊕ #000,#00,#0,#1,#2	⊖ #0,#1,#2	
⊖ 1,1.3,1.5,2,2.5,3,3.5,4 mm	⊕ T3,T4	
⊕ T5H,T6H,T7H,T8H,T9H,T10H,T15H,T20H		
⊖ 0.7,0.9,1.3,1.5,2,2.5,3,3.5,4 mm		
⊕ #0,#1	⊖ 3.0 mm	⊕ 3.0 mm
Pentalobe		⊕ P2,P5,P6 (#one, MacBook Air, MacBook Pro)
6 pcs Ø4.0×30 mm, material : 50BV30 Cr-V steel		
⊖ 2.5,3,3.5,4,4.5,5 mm		
5 pcs Ø1/4"(6.3)×25 mm, material : AISI 8660 Cr-V steel		
#2	⊖ 6.0 mm	⊕ 4.5,5,6 mm
2 pcs Ø1/4"(6.3)×38mm, material : AISI 6150 Cr-V steel		
Torx plus® socket		⊕ TS3.8,TS4.5
		1 pc Ø4.0mm to Ø1/4" adaptor 50 mm
		1 pc Ø4.0×125 mm extension bar
		1 pc TPR non-slip handle
		1 case / 175x73x37mm

SD-9326M Consumer Electronic Equipment Repair Kit



- P2 / P5 / P6 Pentalobe tips are designed for Apple products.
- Allows opening the most of branded smart #one, video game, notebook, electronic devices and more.
- Ratchet design for force saving.

CONTENTS

Non-slip handle with rotating cap		
⊕ P2, P5, P6	⊕ #000, #00, #0, #1	
⊖ 2, 2.5, 3, 4mm	⊖ 0.7, 1.5, 2, 3mm	
⊕ PZ1, PZ0	⊖ Spanner 2.6	
⊕ T4, T5, T6, T8, T10, T15, T20		
⊕ TA2.0	⊕ TRI00, TRI0, TRI1	⊕ PIN
		1 pc double-ended metal spudger OAL:185mm
		1 pc nylon aid tools, OAL:150mm
		2 pcs polyoxymethylene (POM) opening levers, OAL:84.4mm, 88.7mm
		1 pc prying paddle, 30.5x30.5x30.5mm
		Suction cup OAL:36mm
		1 case / 225x125x51mm

HEX KEY WRENCHES



HW-230BL 9 PCS Color Code Extra Long Arm Ball Point Hex Key Set

- S2 steel magnetizer color code.

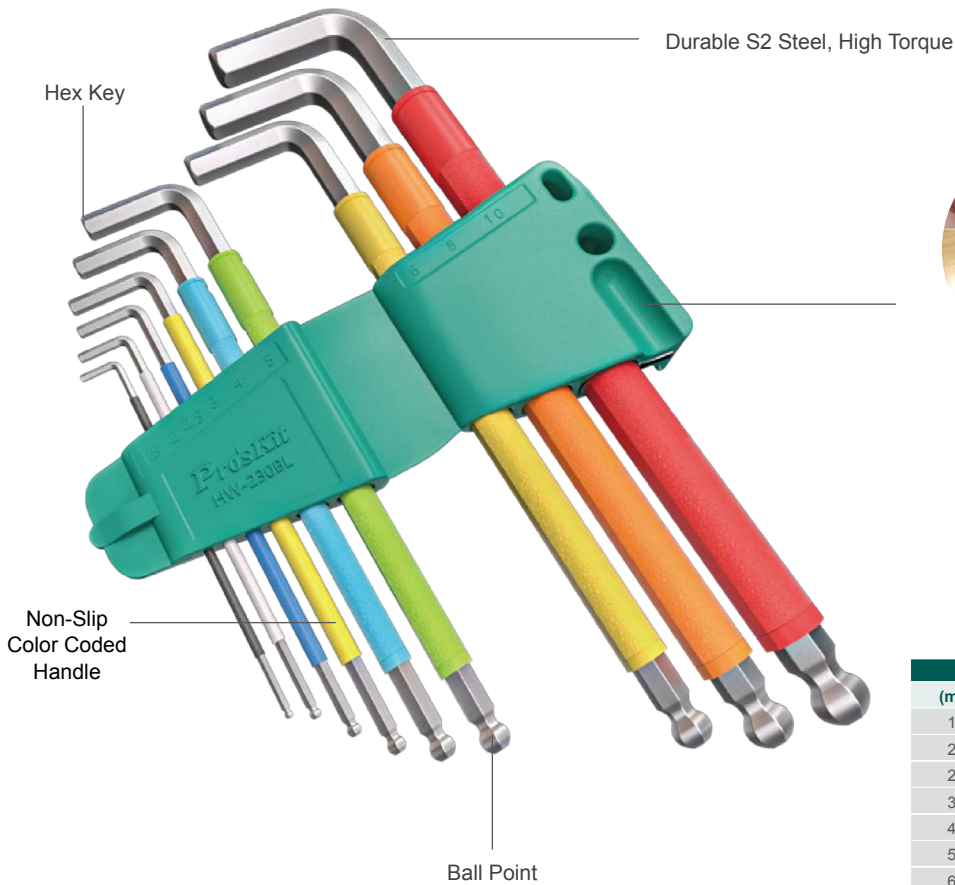

Magnetizer Case

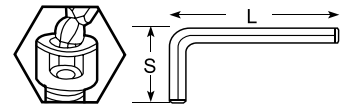

Tip Size (mm)			
(mm)	S	L	Color
1.5	14	92	Black
2.0	16	104	White
2.5	20	115	Blue
3.0	23	130	Light yellow
4.0	28	145	Light blue
5.0	32	162	Green
6.0	36	185	Yellow
8.0	41	208	Orange
10	50	233	Red

8PK-022 7 PCS Miniature L Shaped Hex Key Set

- Precision fastening
- Key material: SAE 6150 with blackened finished.

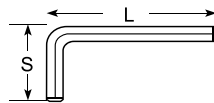

Tip Size (mm)		
(mm)	S	L
0.7	8	35
0.9	10	38
1.3	12	41
1.5	14	45
2	17	50
2.5	19	56
3	20	65

HW-023 8 PCS Ring Type Hex Key Set

- Key material: SAE 6150 with blackened finished.

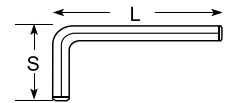

Tip Size (mm)		
(mm)	S	L
1.5	15	45
2	17	52
2.5	20	58
3	22	66
4	28	73
5	33	85
5.5	35	91
6	37	96

8PK-027 30 PCS Metric & Inch Combination Hex Key Set



- Lead free.
- Portable packaging.
- Key Material:SAE 6150 with blackened finished.

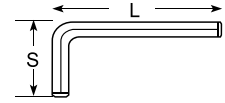

Tip size (Inch)	S (mm)	L (mm)	Tip size (Inch)	S (mm)	L (mm)	Tip size (Inch)	S (mm)	L (mm)	Tip size (Inch)	S (mm)	L (mm)
0.028"	8	65	0.7	8	35	9/64"	23	105	4.5	30	79
0.035"	11	69	0.9	11	39	5/32"	24	108	5	32	85
0.050"	13	73	1.3	13	42	3/16"	28	118	5.5	34	90
1/16"	15	78	1.5	15	46	7/32"	31	129	6	37	95
5/64"	16	84	2	18	52	1/4"	34	141	7	40	102
3/32"	19	90	2.5	20	58	5/16"	39	159	8	43	107
7/64"	21	95	3	23	66	3/8"	43	179	10	49	121
1/8"	22	99	4	29	73	Case Size	132x93x32 mm				

HW-129 9 PCS Long Arm Hex Key Set



- Key material : SAE 6150 with satin finished.

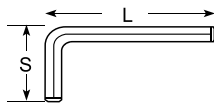

Tip Size (mm)		
(mm)	S	L
1.5	15	79
2	18	84
2.5	20	91
3	22	101
4	28	108
5	32	121
6	37	144
8	43	166
10	49	178

8PK-028 9 PCS Ball-Point Hex Key Set



- Lead free.
- Key material : S2 alloy steel with blackened finished.

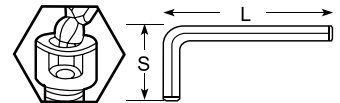

Tip Size (mm)		
(mm)	S	L
1.5	16	79
2	18	86
2.5	21	93
3	23	99
4	29	109
5	32	119
6	37	140
8	43	162
10	50	180

HW-229B 9 PCS Ball Point Long Arm Hex Key Set



- Lead free.
- Key material : SAE 6150 with satin finished.

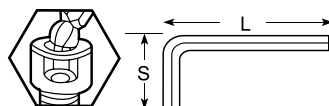

Tip Size (mm)		
(mm)	S	L
1.5	15.5	63.5
2	18	76
2.5	20.5	85.5
3	23	91
4	29	102
5	33	118
6	38	139
8	44	155
10	50	177

HW-229BL 9 PCS Extra Long Arm Ball Point Hex Key Set



- Lead free.
- Key material : SAE 6150 with satin finished.

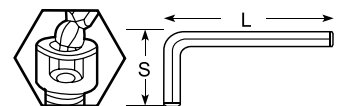

Tip Size (mm)		
(mm)	S	L
1.5	15.5	90.5
2	18	101
2.5	20.5	112.5
3	23	127
4	29	142
5	33	163
6	38	184
8	44	205
10	50	231

8PK-021N/8PK-021NA 7 PCS Folding Hex Key Set

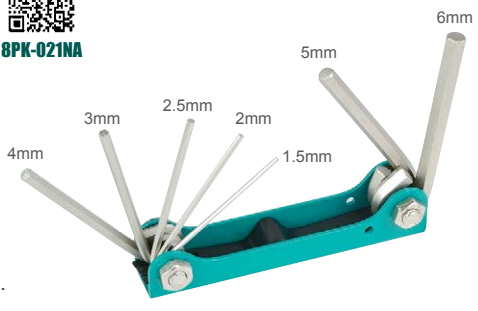

- Lead free.

8PK-021N	8PK-021NA
● 1.5, 2, 2.5, 3, 4, 5, 6mm	● 1/16", 5/64", 3/32", 1/8", 5/32", 3/16", 1/4"
Material: SAE6150 with satin finish / Green lacquered	
OAL.(mm): 93x24x24	

8PK-021T 8 PCS Folding Tamper-proof Star Key Wrench Set

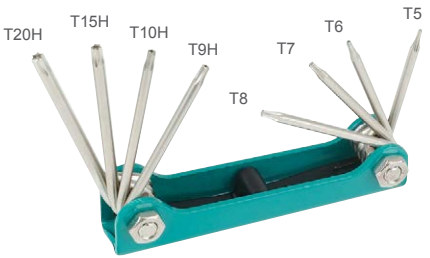

- Lead free.

CONTENTS	
● T5, T6, T7, T8	● T9H, T10H, T15H, T20H
Material: SAE6150 with satin finish / Green lacquered	
OAL (mm): 93x24x21	

HW-121L 8 PCS Folding Tamper-proof Star Key Wrench Set



CONTENTS	
● T9H, T10H, T15H, T20H, T25H, T27H, T30H, T40H	
Material: SAE 6150 with satin finish / T.P.R. anti-slip.	
OAL (mm): 109x43x23	

8PK-021L 8 PCS Folding Tamper-proof Star Key Wrench Set

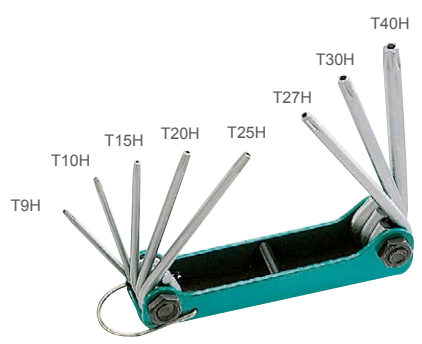

- Lead free.

CONTENTS	
● T9H, T10H, T15H, T20H, T25H, T27H, T30H, T40H	
Material: SAE8660 with satin finish / Green lacquered	
OAL.(mm): 112x30x30	

HW-221M 8 PCS Aluminum Case Folding Hex Key Set



- Lead free.

CONTENTS	
● 1.5, 2, 2.5, 3, 4, 5, 6, 8	
Material: SAE 6150 with satin finish / Anodized aluminum	
OAL (mm): 104x36x22	

HW-121M 8 PCS Folding Hex Key Set

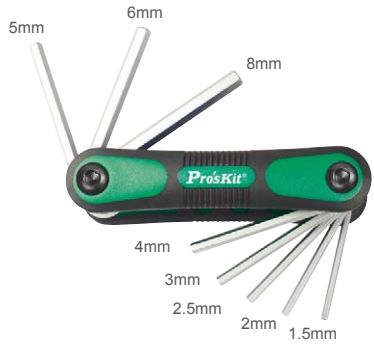

CONTENTS	
● 1.5, 2, 2.5, 3, 4, 5, 6, 8mm	
Material: SAE 6150 with satin finish / T.P.R. anti-slip.	
OAL (mm): 109x43x23	

SOCKET WRENCHES



HW-T Series Adjustable Torque Wrench With Reversible Ratchet



HW-T41-315



HW-T21-60340

INDUSTRIAL GRADE

ASME B107.300-2010

DIN ISO 6789

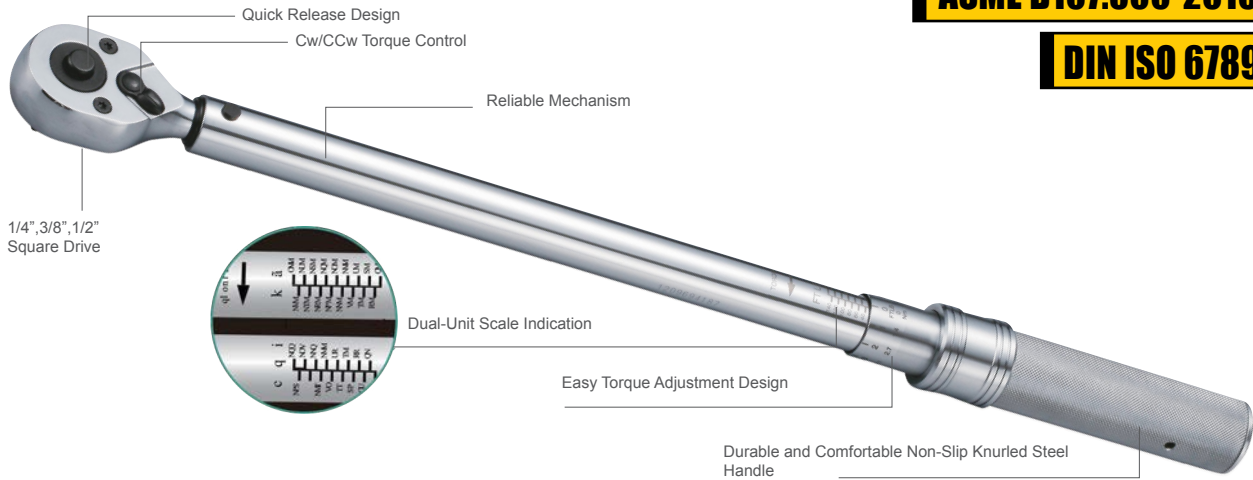

Spec.	HW-T41-315	HW-T21-60340
Drive	1/4"/6.35mm Square	1/2"/12.70mm Square
Unit	N-m/lbf.ft Dual-unit	
Torque range	3.0~15 N-m / 31~128 lbf.in	60~340 N-m / 52~243 lbf.in
Accuracy	±3.0 %	
Graduation	0.1 N-m	2.0 N-m
Gear teeth	64 T	32 T
OAL	210 mm (8.3")	610 mm (24")

HW-318 Multifunction Socket Wrench



- 12 Point.
- 48 in 1.
- Quickly change.
- Rotating head.



Material Body	Socket	Handle	Hardness	Torque	Size Spec.	Weight	OAL.(mm)
S45C	40Cr	ABS+TPE	HRC 43°±5°	200N.m	Metric:8,10,11,13,14,16,17,19mm Inch:5/16",3/8",7/16",1/2",9/16",5/8",11/16",3/4"	450±30g	255mm ±10mm

SD-T635 Series Adjustable Torque Screwdriver



- CW/CCW torque control.
- Easy torque adjustment.



Dual-Unit Scale Indication

INDUSTRIAL GRADE

ASME B107.300-2010

DIN ISO 6789



Model	SD-T635-0112	SD-T635-16	SD-T635-510
Drive	1/4"/6.35mm hexagon		
Unit	N-m/lbf.ft Dual-unit		
Torque range	0.1~1.2 N-m / 1.33~10.18 lbf-in	1.0~6.0 N-m / 13.28~48.68 lbf-in	5.0~10 N-m / 48.68~84.08 lbf-in
Accuracy	±6.0 %		
Graduation	0.01 N-m	0.1 N-m	
OAL	180 mm	200 mm	

1PK-H & HW Series Adjustable Wrenches



1PK-H026



1PK-H028



HW-010



HW-012

- Lead free.
- Precision machined jaws: Ensures exact fit and smooth adjustment.
- Drop forged carbon steel construction: Rust-resistant with a polished chrome finish.
- Hex jaw design: Provides a more secure fit and reduces slippage.
- PVC coated handles.
- Handle hole: For easy hanging or storage.



Model	1PK-H026	1PK-H028	HW-010	HW-012
Material	S45C			
Jaw open (Max)	13/16"(19mm)	1"(25mm)	1-3/16"(30mm)	1-7/16"(36mm)
OAL	6"(150mm)	8"(200mm)	10"(250mm)	12"(300mm)

HW-6509B/6514B Combination Wrench



HW-6509B



HW-6514B

40Cr (AISI5140):
Forged from the highest
quality alloy steel.

Corrosion resistant.

Open ends are offset at
standard 15° angle for
confined working areas.



Box ends:
Offset at a 15° angle to provide
clearance over obstructions.

Open ends and box wrenches:
Both ends have the same size
opening.



Tool pouch

HW-6509B



HW-6514B



HW-6509B

9PCS Combination Wrench (Metric)

● 8, 10, 11, 12, 13, 14, 15, 17, 19mm

HW-6514B

14PCS Combination Wrench (Metric)

● 8, 9, 10, 11, 12, 13, 14, 15, 16, 17, 18, 19, 22, 24mm

HW-7509B/7513B Double Open-End Wrench



HW-7509B



HW-7513B

40Cr (AISI5140).
Forged from the highest
quality alloy steel.

Corrosion resistant.

Ends: Offset at a 15° angle for
clearance over obstructions.



Different size openings:
Each end of the wrench
has a different size.



Tool pouch

HW-7509B



HW-7513B



HW-7509B

9PCS Double Open-End Wrench (Metric)

● 6x7, 8x10, 11x13, 12x14, 14x17, 17x19, 21x23, 22x24, 24x27mm

HW-7513B

13PCS Double Open-End Wrench (Metric)

● 6x7, 8x10, 10x12, 11x13, 12x14, 14x17, 17x19, 19x21, 21x23, 22x24, 24x27, 27x30, 30x32mm

HW-609A/HW-609B 10 PCS Electronic Combination Wrench



HW-609A



HW-609B

- Lead free.
- 10-piece electronic combination wrench set. Open and box-end wrenches made from AISI 1045, drop-forged and heat-treated.



Spec.	HW-609A (Inch Size)	HW-609B (Metric Size)
Box end	7/16", 11/32", 3/8", 9/32", 5/16", 1/4", 15/64", 7/32", 5/32", 3/16"	11, 10, 9, 8, 7, 6, 6, 5.5, 4.5, 4, 4mm
Open end	3/8", 5/16", 11/32", 1/4", 9/32", 15/64", 7/32", 13/64", 3/16", 5/32"	10, 9, 8, 7, 6, 5.5, 5, 5, 4, 4.5mm

HW-5907M Flex Head Ratcheting Wrench



- Lead free.
- Ratcheting box end set at 0°~180°.
- Open end set at 15°.
- Material: AISI 1045.

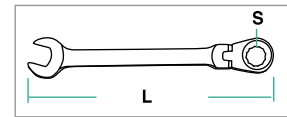

S(mm)	L(mm)
8	139
10	157
11	175
13	194
14	212
17	231
19	250



8PK-SD016 23 PCS 1/4" Driver Socket Set



CONTENTS
6" Spinner handle
3" Extension bar
6" Extension bar
5" Ratchet handle (1/4")
18 pcs sockets:
Metric: 4, 5, 6, 7, 8, 9, 10, 11, 12mm
Inch: 3/16", 7/32", 1/4", 9/32", 5/16", 11/32", 3/8", 7/16", 1/2"
Metal box (201X115X40mm)

HW-22401M 24PCS 6.3mm Drive Socket Tool Set



- Lead free.



Universal joint



Spinner T-handle



Extension bar with wobble, 2-way

CONTENTS

- 13pcs hand socket 4,4.5,5,5.5,6,7,8,9,10,11,12,13,14mm
- 5pcs hand deep socket 8,10,11,12,13mm
- Extension bar 55mm
- Extension bar w/wobble 2 way 100mm
- Sliding T handle 115mm
- Universal joint
- Spinner handle
- 72 teeth reverse flat ratchet handle w/quick release
- Metal case 245x120x35mm

HW-42601M 26PCS 12.7mm Drive Socket Tool Set



- Lead free.



72-tooth reverse flat ratchet handle

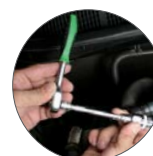

Spark plug socket



Sliding T-handle with quick release

CONTENTS

- 14pcs hand socket 10,12,13,14,15,16,17,18,19,22,24,27,30,32mm
- 4pcs hand deep socket 12,14,17,19mm
- 2pcs spark plug socket w/magnetic 16,21mm
- Extension bar w/quick release 125mm
- Extension bar w/quick release 250mm
- Sliding T handle w/quick release 250mm
- LED light adaptor
- Universal joint
- 72-tooth reverse flat ratchet handle w/quick release
- Metal case 445x185x50mm

HW-23801M 38PCS 6.3mm Drive Socket Tool Set



- Lead free.



Universal joint



Spinner handle



Extension bar w/2 way

CONTENTS

13pcs hand socket 4,4.5,5,5.5,6,7,8,9,10,11,12,13,14mm		
18pcs hand bits socket T10,T15,T20,T25,T30,T40,H3,H4,H5,H6,H8, PH1,PH2,PZ1,PZ2,SL4,SL5.5,SL6.5		
Extension bar 55mm	Extension bar with wobble, 2-way, 100mm	
Sliding T handle 115mm	Universal joint	Adaptor 3/8" F x 1/4" M
Spinner handle	72-tooth reverse flat ratchet handle w/quick release	
Metal case 280x130x40mm		

HW-42401M 24PCS 12.7mm Drive Socket Tool Set



- Lead free.



F type handle



Universal joint



72-tooth reverse flat ratchet handle

CONTENTS

18pcs hand socket 10,11,12,13,14,15,16,17,18,19,20,21,22,23,24,27,30,32mm		
Extension bar 125mm	Extension bar 250mm	Sliding T handle 250mm
F-type handle 375 mm		Universal joint
72-tooth reverse flat ratchet handle w/quick release		
Metal case 445x185x50mm		

HW-612401M 124PCS 6.3mm , 12.7mm Drive Socket Tool Set



- The HW-612401M 124-piece 1/2" and 1/4" drive socket tool set comes in a 3-drawer aluminum tool case for easy organization and includes most popular tools to round out this versatile set.



Top Layer



Drawer 1

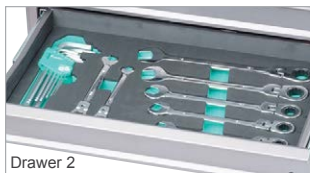

Drawer 2



Drawer 3

CONTENTS

Top Layer : OTR-612401MEVA-1		
23pcs 1/2" hand socket: 8,9,10,11,12,13,14,15,16,17,18,19,20,21,22,23,24,25,27,28,29,30,32mm	1/4" universal joint	
8pcs 1/2" hand deep socket: 10,11,12,13,14,17,19,22mm	1/4" spinner handle	
1/2" Extension bar w/quick release 125mm	1/4" 72-tooth reverse flat ratchet handle w/quick release	
1/2" Extension bar w/quick release 250mm	Adapter 3/8"F x 1/4"M	
1/2" Sliding T handle w/quick release 250mm	Multi-purpose box(OD 99x66x36mm)	
1/2" LED light adapter		
1/2" Universal joint		
1/2" 72-tooth reverse flat ratchet handle w/quick release		
Drawer 1 : OTR-612401MEVA-2		
14pcs 1/4" hand socket: 4,4.5,5,5.5,6,7,8,9,10,11,12,13,14mm		
13pcs 1/4" hand deep socket: 4,4.5,5,5.5,6,7,8,9,10,11,12,13,14mm		
18pcs 1/4" hand bits socket: T10,T15,T20,T25,T30,T40,H3,H6,H4,H5,H8,PH1,PH2,PZ1,PZ2,SL4,SL5.5,SL6.5		
2pcs 1/2" spark plug socket w/magnetic: 16,21mm		
1/4" extension bar w/wobble, 2-way, 52mm		
1/4" extension bar w/wobble, 2-way, 100mm		
1/4" extension bar w/quick release, 150mm		
1/4" sliding T-handle 115mm		
1/4" universal joint		
	Drawer 2 : OTR-612401MEVA-3	
	9pcs ball-point long arm hex key: 1.5,2,2.5,3,4,5,6,8,10mm	
	7pcs flex head gear wrench: 8,10,11,13,14,17,19mm	
	Drawer 3 : OTR-612401MEVA-4	
	8pcs pro-soft screwdriver: SL8x150mm,SL8x100mm,SL6x40mm,SL6x200mm,PH3x150mm,PH2x100mm,PH2x40mm,PH2x250mm	
	Telescopic magnetic pick up tool	
	Cover:	
	3 1/2 compact digital multimeter	
	1PK-051DS: 8" Dual Color Lineman's Plier	
	1PK-067DS: 6" Dual Color Side Cutting Plier	
	1PK-709DS: 6" Dual Color Long Nose Plier	
	2pcs adjustable locking plier set, 9" (long nose)	
	Aluminum frame 3 drawers tool case 485x260x333mm	

* For packing info please refer to the index at the back.

POWER TOOLS



PT-1801A/F 18V Li-ion Impact Cordless Drill Driver



PT-1801A



PT-1801F



- LED working light for improved visibility.
- Stepless variable speed.

ACCESSORIES

5PT-1801-DRI (HSS drills): Ø2.0,2.5,3.4,5,6,1pc 6mm concrete drill bit
 5PT-1206-BIT (CRV bits): PH1, PH2, PZ1, PZ2, SL5, SL6 (L : 25mm),
 60mm magnetic insert bit holder x1
 5PT-1801-BIT1: SL6-PH2 double end driver bit x1
 5PT-1801-BAT: Battery x2
 5PT-1801-ADA/ADF: Adapter x1

MODEL	PT-1801A	PT-1801F
Voltage	AC 120V/60Hz	AC 230V/50Hz
Max. Drilling Capacity	Steel: Ø8 mm / Wood: Ø20 mm / Concrete : Ø10 mm	
No Load Speed	0-350/0-1200 rpm	
Impact/min	0~19200 ipm	
Output Torque	35N.m / 22N.m	
Drive	1/2" (13mm) keyless chuck	
Battery	Includes 2pcs 18V 2.0Ah Li-ion	
Drill Bits Sizes	Ø2.0~Ø13mm	
Weight	3.386kg	

5PT-1801-BAT Battery Pack

- 18V 2.0Ah Li-ion battery complies with latest safety standard.
- No memory effect allows charge and discharge anytime.
- Compatible for PT-1801A/F.



5PT-1801-ADA/ADF Charging Adapter

- About 40 minutes quick charge enables efficient work.



MODEL	5PT-1801-ADA	5PT-1801-ADF
Input Voltage	AC 120V 60Hz	AC 230V 50Hz
Output Voltage	DC 20V 2.4A	DC 20V 2.4A

PT-1206A/F 12V Li-ion Cordless Drill Driver



PT-1206A



PT-1206F



- Dual gear speed.
- Stepless speed control.
- Keyless chuck for fast, one-handed bit changes.

ACCESSORIES

5PT-1206-DRI (HSS drills): 1.5,2.5,3,4,5,6mm
 5PT-1206-BIT (CRV bits): PH1, PH2, PZ1, PZ2, SL5, SL6 (L:25mm),
 60mm magnetic insert bit holder
 5PT-1206-BAT: Battery x1
 5PT-1206-ADA/ADF: Adapter x1

MODEL	PT-1206A	PT-1206F
Voltage	AC 120V/60Hz	AC 230V/50Hz
Max. Drilling Capacity	steel: Ø6mm / wood: Ø18mm	
No Load Speed	0-350/0-1300 rpm	
Output Torque	22N.m / 15N.m	
Drive	3/8" (10mm) keyless chuck	
Battery	12V 1300mAh	
Drill Bits Sizes	Ø0.8-Ø10mm	
Weight	2.077kg	

5PT-1206-BAT Battery Pack

- 12V 1300mAh Li-ion battery complies with latest safety standard.
- No memory effect allows charge and discharge anytime.
- Compatible for PT-1206A/F.



5PT-1206-ADA/ADF Charging Adapter

- 1 hour quick charge for efficient work.



MODEL	5PT-1206-ADA	5PT-1206-ADF
Input Voltage	AC 120V 60Hz	AC 230V 50Hz
Output Voltage	DC 12V 1.5A	DC 12V 1.5A

PT-1366U 3.6V Cordless Electric Screwdriver Set



- Battery indicator function.
- Plastic storage box, convenient for storage.
- 1/4" (6.35mm) hexagonal quick-release bit holder, stable and reliable.

ACCESSORIES

USB Type-C Cable x 1
 Magnetic bits holder (50mm) x 1
 50mm screwdriver bits 4pcs: SL3.0, SL4.0, PH1, PH2
 25mm colouring screwdriver bits 24pcs:
 PH1x2, PH2x2, PH3x2, SL3.0, SL4.0, SL5.0, PZ1, PZ2 T10x1, T15x2, T20x2,
 HEX3.0x2, HEX4.0x2, HEX5.0x1, S0x1, S1x1, S2x1

SPECIFICATIONS

Rated Voltage	3.6V
No Load Speed	320 rpm
Torque Setting	7+1 Positions
Max Torque	5.5N.m (Hard) / 3.5N.m (Soft)
Min Torque	0.2Nm
Collet Holder	1/4" (6.35mm)
Battery	Li-ion 3.6V 2000mAh
Size	Ø38 x 195mm

PT-1362U 3.6V USB Li-ion Cordless Screwdriver



- Full metal gear box.
- USB charging, easy to use in anywhere.
- Full metal gear box, durable and easy to carry.
- Li-ion battery offers high performance and service life.

ACCESSORIES

4pcs 50mm driver bits: SL5.0, SL6.0, #1, #2
 Micro USB charging cord x 1

SPECIFICATIONS

Rated no load speed	200 rpm
Output torque	3.5 N.m
Special function	LED charging indicator
Overall length	140 x 110mm
Battery	Li-ion 3.6V 1500 mAh
Charging time	2~3 hours (5V/1A)
Free running time	~60 min
Size	135 x 127 x 46mm

PT-32030F/PT-32007F/PT-32015F Variable-frequency Electric Screwdriver



NEW



PT-32030F

PT-32007F

PT-32015F

ACCESSORIES

Screwdriver bits x2
 Adapter x1



SPECIFICATIONS	PT-32030F	PT-32007F	PT-32015F
AC/DC	AC 100-240V/60Hz / DC 24-36V	AC 100-240V/60Hz/ DC 24-32V	
Torque	kgf.cm: 5.0-30.0 / N.m: 0.5-3.0	kgf.cm: 1.0~7.0 / N.m: 0.1~0.7	kgf.cm: 2.0~15.0 / N.m: 0.2~1.5
Torque accuracy(%)	±5%		
No Load Speed (r/min)	700~1200	900~1200	
Product Size	250x60x42mm	285x100x65mm	
Available bits	S 1/4	Ø4mm	Ø5mm
Weight	700g	490g	490g

PT-5208U 8V Li-ion Anti-locked Safety Grinder Set



NEW



Type C port

ACCESSORIES

1/4" Sanding bands x 6, 1/2" Sanding bands x 6, Sander paper x 24, Grinding Stones x 5, Sanding drums x 2, Steel and Nylon brush, Whetstone x 1, 3.2mm(Assembled) and 2.3mm collet, Spanner, Felt wheels x 4, Grinding wheel x 2, 3.5mm and 2.5mm Drills bits x 2, Diamond bit x 2, Screw mandrel x 2

PT-5206U 3.6V Li-ion USB Grinder Set



- Ideal for cutting, sanding, grinding, carving for any home improvement or crafting job.

ACCESSORIES

Micro USB charging cord x1, Wrench x1, Ø2.4mm colletx1, Ø3.2mm colletx1 Mandrel for sanding bandx1, Mandrel for cutting wheelx1, Sanding bands x 3, Diamond bit x 1, Grinding stones x 2, Cutting wheels x 2

PT-5205U 3.7V USB Li-ion Mini Grinder Set



- USB charging easy to use in anywhere.
- Compact and cordless break space limit.

ACCESSORIES

Sanding band x2, Diamond bits x2, Grinding stones x2, Engraving bit x1, Nylon brush x1, Mandrel for sanding band x1, Ø 2.4mm collet x1, Ø3.2mm collet x1, Micro USB charging cord x 1

SPECIFICATIONS	PT-5208U	PT-5206U	PT-5205U
Rated no load speed	5000~28000 rpm	10,000 / 20,000 rpm	5000/10000/15000 rpm
Drive		Ø2.4 / Ø3.2 mm	
Battery	8V 2000mAh Li-ion	3.6V 1500mAh	3.7V 600mAh
Charging Port	Type-C	Micro USB	Micro USB
Charging time	~2.5h	2.5~5hr.	~2h (5V/0.5A)
Free running time	~90 mins	~55 mins	~100 mins
Size	45x46x215mm	193x51x37mm (main body)	145x31mm
Weight (Accessory is not included)	358g	250g	90g

PT-5501I Variable Speed Rotary Tool Kit



Carrying case

ACCESSORIES

Round needle tip x1, Flat tip x1, Mandrel for polishing felt x1, Grinding wheels x10, Grinding bits x2, Mandrel for grinding wheel x1, Sanding wheel x8, Sanding paper x3, Hex key wrench x1, Polishing felt (Ø 12mm, Ø 21mm) each x2, Mandrel for sanding band x1, Sanding band x4, Collet (Ø 2.5, Ø 3.2) each x1, High speed drill (Ø 3.2, Ø 2.3) each x1, Whetstone x1, Wrench x1

SPECIFICATIONS

Maximum output (Power)	135 W
No load speed	10,000-32,000 rpm
Collet chuck capacity	Ø3.2mm and 2.5mm
Voltage	230V, 50Hz
Carrying case size	285x235x80(mm)

PT-5201NA/NF Mini Grinder



NEW



- The quick-change chuck is ideal for drilling, polishing, engraving, routing, shaping, sanding and milling.

ACCESSORIES

Diamond bits x2, Grindingstones x2, Sanding bands x2, Collet (Ø 2.4/ Ø 3.2 mm) x2, Nylon brush x1, Connective post for sanding band x1

MODEL	PT-5201NA	PT-5201NF
Max. diameter	ø3.2mm	
No load speed	5000~22000 rpm adjustable	
Adapter voltage	Output: 18V 800mA Input: 100~240V 50/60Hz	
Replacement accessories	9PT-5201-P2 (10 pcs/set)	
Replacement adapter	9PT-5201NA-P	9PT-5201NF-P

PT-5100 Rotary Tool Accessory Kits



- Suitable for: PT-5501, PT-5201 and PT-5202 series and other most rotary type tools.

CONTENTS

1pc HSS Cutter	10pcs felt polishing sheets
1pc mandrel for felt wheels	5pcs diamond wheel points
4pcs sanding bands	1pc mandrel for cut-off wheels
4pcs grinding wheels	40pcs sanding discs
2pcs mandrel for sanding bands	2pcs steel brush
36pcs cut-off wheels	1pc felt tip
2pcs collets:ø3.2mm / Shank ø4.8mm	Size: 220x128x46mm

PT-5202F Mini Grinder Set



- Build-in LED light.
- Including 19 accessories and 2 stencils.
- Durable plastic storage case.

SPECIFICATIONS

Collet size	Max. Ø3.2mm
No-load speed	15,000 rpm
Working voltage	18V DC
Acoustic pressure	<70dB
Overall length	Ø43x127 mm
Weight	123 g
Input voltage	100~240VAC 50/60Hz 0.5A Max.
Output voltage	18V DC 400mA

ESD STATIC



8PK-611 Wrist Strap 



- ESD safe.



Wrist strap resistance	Wrist strap system resistance	Wrist belt	Cord size (feet)
< 1x10 ⁵ Ω	10 ⁶ Ω	Fixed	10 (3M)

AS-611 Wrist Strap 



- ESD safe.
- Economic type.



Wrist strap resistance	Wrist strap system resistance	Wrist belt	Cord size (feet)
< 1x10 ⁵ Ω	10 ⁶ Ω	Fixed	10 (3M)

8PK-611D Wrist Strap 



- ESD safe.

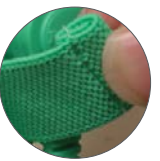

Wrist strap resistance	Wrist strap system resistance	Wrist belt	Cord size (feet)
< 1x10 ⁵ Ω	10 ⁶ Ω	Adjustable	10 (3M)

608-611C Wrist Strap 



- ESD safe.



Wrist strap resistance	Wrist strap system resistance	Wrist belt	Cord size (feet)
< 1x10 ⁵ Ω	10 ⁶ Ω	Adjustable	10 (3M)

AS-612F Quick-Fasten Wrist Band 



- ESD safe.



Wrist strap resistance	Wrist strap system resistance	Wrist belt	Cord size (feet)
< 1x10 ⁵ Ω	10 ⁶ Ω	Adjustable	6 (1.8M)

8PK-611W Replaceable Cordless Wrist Strap 



- ESD safe.
- Cordless.
- For high humidity environment.



Wrist strap resistance	Wrist belt
< 1x10 ⁵ Ω	Adjustable

608-611B/608-611B-6 Wrist Strap 



608-611B



608-611B-6



- ESD safe.

MODEL	608-611B	608-611B-6
Wrist strap resistance	< 1x10 ⁵ Ω	
Wrist strap system resistance	10 ⁶ Ω	
Wrist belt	Adjustable	
Cord size (feet)	10 (3M)	6 (1.8M)

8PK-AS07-1 Field Service Kit



- ESD safe.



Material	Conductive PVC
Resistance	$10^9 - 10^{11}\Omega$
Wrist belt	With 6ft wrist strap and 10ft grounding wire w/bottom
Size(mm)	650x600

8BM-401A/8BM-405A/8BM-612A Static-Dissipative Mat



- ESD safe.

MODEL	8BM-401A	8BM-405A	8BM-612A
Material	Face layer: 0.2mm laminated PVC , Center layer: 1.7mm PVC foam, Bottom layer: 0.1mm PVC foam, Combination layer: conductive treatment		
Resistance	Face & Center & Bottom, Layers: $10M \sim 1KM\Omega/SQ$ Combination layer: $1K \sim 1M\Omega/SQ$, Static decay time: less than 0.5sec Surface resistance: $10^8 \sim 10^{10}\Omega$		
Total thickness	2mm		
Size(mm)	500x600	600x600	600x1200

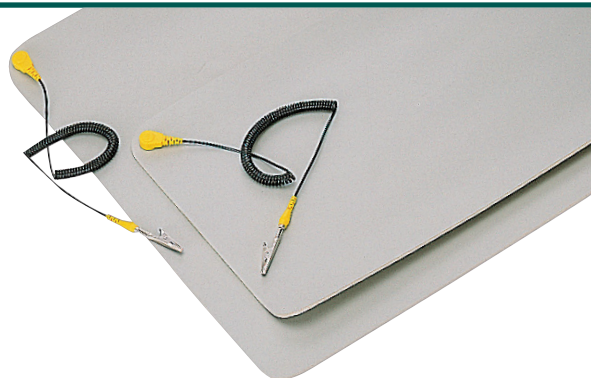

808-Q03-1 Anti-Dissipative Table Mat



- ESD safe.

Material	Rubber
Resistance	Top layers: $10^8 \sim 10^{10}\Omega$, Bottom layer: $10^4 \sim 10^6\Omega$
Size	10x1m, Thickness: 2mm

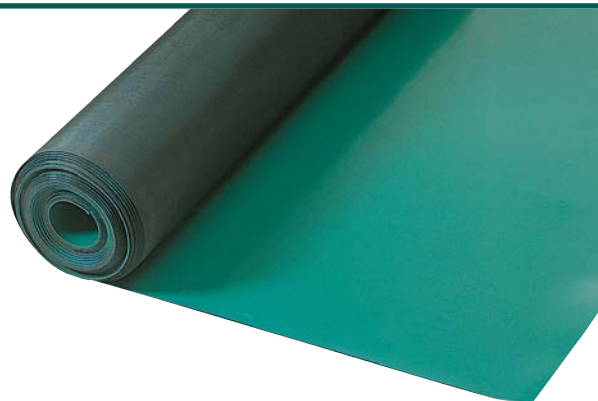

AS-501 Series Static Brush



- ESD safe.

MODEL	AS-501A	AS-501B	AS-501C	AS-501D	AS-501E
Material	Conductive p.p.				
Resistance	$10^3 \sim 10^9\Omega$				
OAL.(mm)	180	173	255	92	143

VDE INSULATION TOOLS





IMPACT TEST

Our VDE products have passed through multiple tests including dielectric test, low temperature impact test, high temperature adhesive power test, and burning behavior test.

PM-910 Insulated Wire Stripping Plier



- Wire spring.

Material	HRC body	Solid wire	Stranded wire	OAL (mm)
AISI 6150	46°±4°	Ø0-5mm	0-10mm ²	160

PM-911 Insulated Combination Plier



- Serrated tip.

Material	HRC body	Hard steel	Soft wire	OAL (mm)
AISI 6150	46°±4°	Ø2.5mm	Ø3.8mm	195

PM-912 Insulated Combination Plier



- Serrated tip.

Material	HRC body	Hard steel	Soft wire	OAL (mm)
AISI 6150	46°±4°	Ø2.0mm	Ø3.1mm	175

PM-918 Insulated Long Nose Plier



- Serrated tip.

Material	HRC body	Hard steel	Soft wire	OAL (mm)
AISI 6150	46°±4°	Ø2.2mm	Ø3.2mm	200

PM-916 Insulated Heavy Duty Side Plier



Material	HRC body	Hard steel	Soft wire	OAL (mm)
AISI 6150	46°±4°	Ø2.7mm	Ø3.8mm	190

PM-919 Insulated Long Nose Plier



- Serrated tip.

Material	HRC body	Hard steel	Soft wire	OAL (mm)
AISI 6150	46°±4°	Ø1.6mm	Ø2.5mm	170

PM-917 Insulated Side Cutter



Material	HRC body	Hard steel	Soft wire	OAL (mm)
AISI 6150	46°±4°	Ø2.0mm	Ø2.8mm	165

SR-V206/SR-V210 VDE 1000V Insulated Cable Cutter



SR-V206



SR-V210



SR-V537 VDE 1000V Insulated Ratchet Cable Cutter



Ratchet drive for easier cutting

MODEL	SR-V206	SR-V210	SR-V537
Material	Cr-Mo	Cr-Mo	65Mn
HRC body	43 \pm 3*	43 \pm 3*	38 \pm 43*
HRC Cutting edge			50 \pm 2*
Diameter	\varnothing 5.2mm	\varnothing 10.0mm	\varnothing 32mm
Cross-sectional area	22mm ²	80mm ²	240mm ²
AWG	4	3/0	500
OAL (mm)	150	250	240

SR-V336 VDE 1000V Insulated Electricians Scissors



Material	HRC	Blade length	OAL (mm)
AISI 420J2	48 \pm 52*	47mm	160mm

MS-V001 VDE 1000V Insulated Tape



Material	Width	OAL (m)
PVC	20mm	10

SOCKET
WRENCHES

POWER TOOLS

ESD STATIC
PROTECTION

VDE TOOLS

PRECISION
TWEEZERS

MAGNIFIER
& LAMP

KNIVES
& SCISSORS

MISCELLANEOUS

INSTRUMENT
CASES

TOOL CASES

INDEX

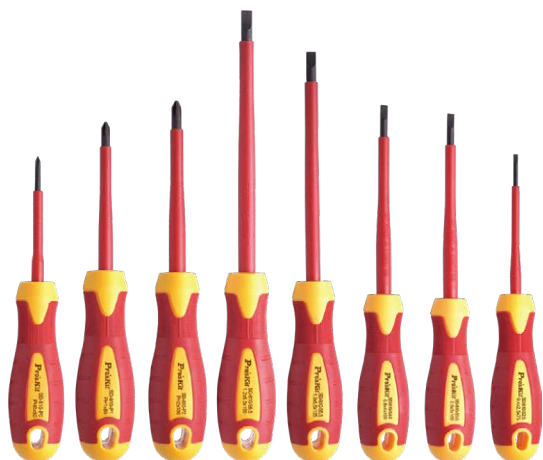
SD-810 Series Insulated VDE Screwdriver

- Magnetic tip.
- S2 alloy steel.

MODEL	Specification	Blade Length
⊖		
SD-810-S2.5	0.4 x 2.5	75mm
SD-810-S3.0	0.5 x 3	100mm
SD-810-S4.0	0.8 x 4	100mm
SD-810-S5.5	1.0 x 5.5	125mm
SD-810-S6.5	1.2 x 6.5	150mm
⊕		
SD-810-P0	#0	60mm
SD-810-P1	#1	80mm
SD-810-P2	#2	100mm

SD-8012 7PCS Insulated VDE Screwdriver Set

- Magnetic tip.
- S2 alloy steel.

MODEL	Specification	Blade Length
⊖		
SD-810-S2.5	0.4 x 2.5	75mm
SD-810-S4.0	0.8 x 4	100mm
SD-810-S5.5	1.0 x 5.5	125mm
SD-810-S6.5	1.2 x 6.5	150mm
⊕		
SD-810-P0	#0	60mm
SD-810-P1	#1	80mm
SD-810-P2	#2	100mm

8PK-8100E Insulated Screwdriver Set

- Magnetic tip.
- AISI8660 Cr-Mo-V steel hardened blade.

CONTENT	
⊖	2.5 x 85mm
⊖	4.0 x 100mm
⊖	5.5 x 125mm
⊖	6.5 x 150mm
⊕	#0x75mm
⊕	#1x100mm
⊕	#2x100mm

TZ-V3 Series VDE 1000V Insulated Tweezers



- Non-magnetic.
- Gripping surfaces with matt finished for optimum grip.



TZ-V302A Sharp tip



TZ-V302B Curved tip



TZ-V302C Round point



TZ-V302D Wide tip



MODEL	TZ-V302A	TZ-V302B	TZ-V302C	TZ-V302D
Material	AISI 304			
HRC	35°-45°			
Width(mm)	15.6	13.0	13.0	15.0
OAL (mm)	134	159	160	145

PD-V Series VDE 1000V Insulated Cable Knife

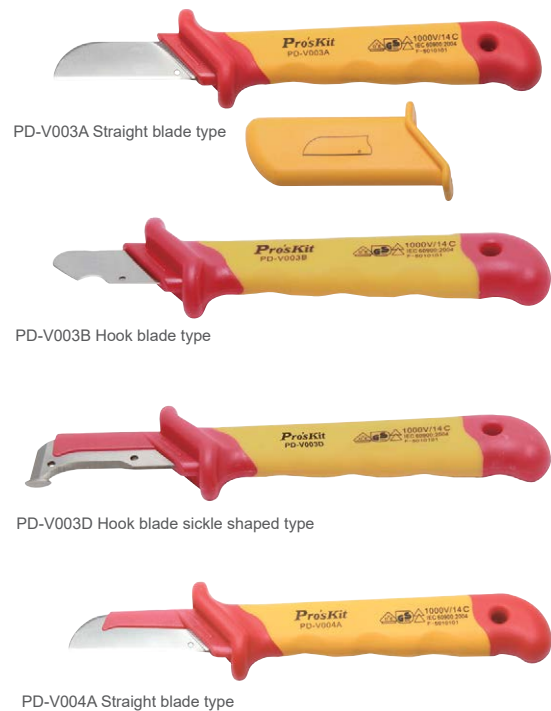

MODEL	PD-V003A	PD-V003B	PD-V003D	PD-V004A
Material	3Cr13			
HRC	50°-58°			
Blade Length (mm)	54	33	51	54
Radius(mm)	-	7	23.5	-
OAL (mm)	186	170	185	185

HW-V6 Series VDE 1000V Insulated Adjustable Wrench



MODEL	HW-V608	HW-V610	HW-V612
Material	50CrV		
Jaw open (Max.) mm	30	34	41
Jaw depth (mm)	25	30	36
Jaw thickness (mm)	12-8	14-9	17-11
OAL (mm)	200	250	300

HW-V1 Series VDE 1000V Insulated Single Open End Wrench

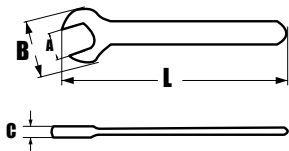

- 15° angled jaw.
- Chrome vanadium steel.

MODEL	Material	(A) Width across flats mm	(B) Head width Max. mm	(C) Head thickness Max. mm	(L)OAL. ±2 mm
HW-V106B	50CrV	6	22	7.2	90
HW-V107B		7	24	7.2	90
HW-V108B		8	25	7.7	100
HW-V109B		9	28	7.7	100
HW-V110B		10	29	8.0	110
HW-V111B		11	31	8.7	110
HW-V112B		12	33	8.7	130
HW-V113B		13	34	10.2	135
HW-V114B		14	37	10.5	145
HW-V115B		15	40	11.0	150
HW-V116B		16	42	11.5	160
HW-V117B		17	44	12.2	160
HW-V119B		19	48	12.2	175
HW-V122B		22	54	13.0	195
HW-V124B	24	56	13.5	225	

PK-2811M 15 PCS 1000V Insulated single Open End Wrench Set

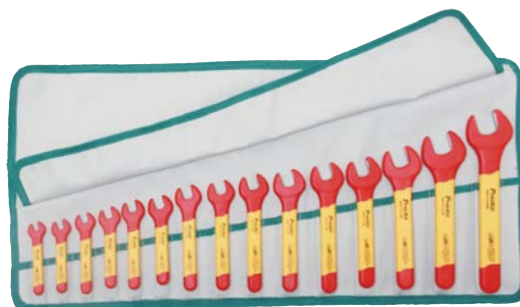

600D tool roll bag:
305x635mm

MODEL	Material	(A) Width across flats mm	(B) Head width Max. mm	(C) Head thickness Max. mm	(L)OAL. ±2 mm
HW-V106B	50CrV	6	22	7.2	90
HW-V107B		7	24	7.2	90
HW-V108B		8	25	7.7	100
HW-V109B		9	28	7.7	100
HW-V110B		10	29	8.0	110
HW-V111B		11	31	8.7	110
HW-V112B		12	33	8.7	130
HW-V113B		13	34	10.2	135
HW-V114B		14	37	10.5	145
HW-V115B		15	40	11.0	150
HW-V116B		16	42	11.5	160
HW-V117B		17	44	12.2	160
HW-V119B		19	48	12.2	175
HW-V122B		22	54	13.0	195
HW-V124B		24	56	13.5	225

HW-V2 Series VDE 1000V Insulated Single Box End Wrench



- Chrome vanadium steel.
- Cranked.

MODEL	Material	(A) Width across flats mm	(B) Head width Max. mm	(C) Head thickness Max. mm	(D) Depth of crank mm	(L)OAL. ±2 mm
HW-V210B	50CrV	10	21.0	8.8	30	170
HW-V213B		13	25.7	10.2	33	190
HW-V214B		14	26.0	11.0	35	205
HW-V217B		17	30.6	12.3	37	215
HW-V219B		19	33.5	13.2	39	230
HW-V222B		22	37.5	13.9	44	245

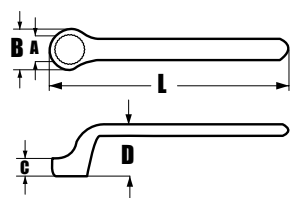

HW-V710 VDE 1000V Insulated Reverse Flat Ratchet Handle



- Clockwise and anti-clockwise directions.
- Chrome vanadium steel.

Material Body	Material Square drive	Square drive	Teeth	OAL (mm)
AISI 6140	42CrMo	1/2"	36	235

SK-V752 VDE 1000V Insulated T Handle



Material	Square drive	Handle length (mm)	Drive length (mm)
50BV30	1/2"	160	200

SK-V4 Series VDE 1000V Insulated 1/2" Drive Socket



- 1/2" Square Drive.
- For metric hexagonal head screws.
- Chrome Vanadium steel.

MODEL	Material	Width across flats mm	Outside diameter Max. mm	Length mm
SK-V410B	50BV30	10	19.5	38
SK-V411B		11	20.7	
SK-V412B		12	22.0	
SK-V413B		13	23.2	
SK-V414B		14	24.5	
SK-V416B		16	27.0	
SK-V417B		17	28.2	
SK-V418B		18	29.5	
SK-V419B		19	30.7	
SK-V422B		22	34.5	
SK-V424B		24	37.0	

SK-V8 Series VDE 1000V Insulated Extension Bar



- With internal and external square.
- Quick, easy and reliable locking of attached sockets.
- Chrome vanadium steel, forged.

MODEL	SK-V851	SK-V852
Material	50BV30	
Square drive	1/2"	
OAL (mm)	125	250

SD-V861 13PCS VDE Screwdriver Kit



- Soft & non-slip grip design.
- Insulated & CR-V steel.
- Magnetic tips.



CONTENT			
⊖	1.2 x 6.5 x 100mm	⊕	PZ2 x 100mm
⊖	1 x 5.5 x 100mm	⊕	PZ1 x 80mm
⊖	0.8 x 4 x 100mm	⊕	T10 x 100mm
⊖	0.5 x 3 x 100mm	⊕	T15 x 100mm
⊕	PH2 x 100mm	⊕	T20 x 100mm
⊕	PH1 x 80mm		
1 pc Voltage detector (AC110V-250V)			
Storage Case: 210 x 131 x 44mm			

PK-2801 1000V Insulated Screwdriver & Plier Set



MODEL	CONTENTS	
SD-810-S2.5	⊖	2.5 x 75mm
SD-810-S3.0	⊖	3.0 x 100mm
SD-810-S5.5	⊖	5.5 x 125mm
SD-810-P1	⊕	PH1 x 80mm
SD-810-P2	⊕	PH2 x 100mm
PM-910	Insulated wire stripping plier (160mm)	
PM-917	Insulated side cutter (165mm)	
PM-919	Insulated long nose plier (170mm)	
9PT-33	Tool bag (255x172x55mm)	

PK-2810A / B 1000V Insulated Tool Kit



MODEL	CONTENTS
SI-130A-20	PK-2810A - Soldering iron(AC110-120V)
SI-130B-20	PK-2810B - Soldering iron(AC220-240V)
SD-810-P0	⊕ Insulated screwdriver (#0x60mm)
SD-810-P1	⊕ Insulated screwdriver (#1x80mm)
SD-810-P2	⊕ Insulated screwdriver (#2x100mm)
SD-810-S2.5	⊖ Insulated screwdriver (2.5x75mm)
SD-810-S4.0	⊖ Insulated screwdriver (4.0x100mm)
SD-810-S5.5	⊖ Insulated screwdriver (5.5x125mm)
SD-810-S6.5	⊖ Insulated screwdriver (6.5x150mm)
PM-910	Insulated wire stripping plier (160mm)
PM-911	Insulated combination plier (195mm)
PM-917	Insulated side cutter (165mm)
PM-919	Insulated long nose plier (170mm)
9DP-S002	Lead free solder dispenser (sn99.3%,Cu0.7%)
NT-305N	Voltage detector
HW-V608	Insulated 8" adjustable wrench
SR-V336	Insulated electricians scissors (160mm)
MS-V001	Insulated tape 20mm x 10m
MT-1232	3 3/4 Digital multimeter
DP-366J	Desoldering pump
9ST-PK2810B	Zipper carrying bag (355x270x60mm)

PK-2813M 1000V Insulated Roll Tool Set



MODEL	CONTENTS
PM-911	Insulated combination plier (195mm)
PM-917	Insulated side cutter(165mm)
PM-910	Insulated wire stripping plier (160mm)
PM-918	Insulated long nose plier(200mm)
SR-V206	Insulated cable cutter 150mm (22mm ²)
HW-V110B	Insulated single open end wrench 10mm
HW-V113B	Insulated single open end wrench 13mm
HW-V114B	Insulated single open end wrench 14mm
HW-V117B	Insulated single open end wrench 17mm
HW-V119B	Insulated single open end wrench 19mm
SD-810-S2.5	⊖ Insulated screwdriver (2.5x75)
SD-810-S4.0	⊖ Insulated screwdriver (4.0x100)
SD-810-S5.5	⊖ Insulated screwdriver (5.5x125)
SD-810-S6.5	⊖ Insulated screwdriver (6.5x150)
PD-V003A	Insulated straight blade cable knife 54x186mm
9Z-PK2813	Tool roll bag

PK-2802 1000V Insulated Plier & Screwdriver Set



MODEL	CONTENTS
SD-810-S2.5	2.5 x 75mm
SD-810-S4.0	4.0 x 100mm
SD-810-S5.5	5.5 x 125mm
SD-810-S6.5	6.5 x 150mm
SD-810-P0	PH0 x 60mm
SD-810-P1	PH1 x 80mm
SD-810-P2	PH2 x 100mm
PM-911	Insulated combination plier (195mm)
PM-917	Insulated side cutter (165mm)
PM-918	Insulated long nose plier (200mm)
PM-919	Insulated long nose plier (170mm)
9Z-PK2802	Zipper carrying bag (294x240x50mm)

PK-2809M 1000V Insulated Metric Tool Kit



MODEL	CONTENTS
PM-911	Insulated combination plier (195mm)
PM-917	Insulated side cutter(165mm)
HW-V110B	Insulated single open end wrench 10mm
HW-V111B	Insulated single open end wrench 11mm
HW-V112B	Insulated single open end wrench 12mm
HW-V113B	Insulated single open end wrench 13mm
HW-V114B	Insulated single open end wrench 14mm
HW-V117B	Insulated single open end wrench 17mm
HW-V119B	Insulated single open end wrench 19mm
SD-810-S2.5	⊖ Insulated screwdriver(2.5x75)
SD-810-S3.0	⊖ Insulated screwdriver(3.0x100)
SD-810-S4.0	⊖ Insulated screwdriver (4.0x100)
SD-810-S5.5	⊖ Insulated screwdriver (5.5x125)
SD-810-P0	⊕ Insulated screwdriver (#0x60)
SD-810-P1	⊕ Insulated screwdriver (#1x80)
SD-810-P2	⊕ Insulated screwdriver (#2x100)
SK-V752	Insulated 1/2" drive T handle 200mm
SK-V410B	Insulated 1/2" drive socket 10mm
SK-V411B	Insulated 1/2" drive socket 11mm
SK-V412B	Insulated 1/2" drive socket 12mm
SK-V413B	Insulated 1/2" drive socket 13mm
SK-V414B	Insulated 1/2" drive socket 14mm
SK-V417B	Insulated 1/2" drive socket 17mm
SK-V419B	Insulated 1/2" drive socket 19mm
PD-V003A	Insulated straight blade cable knife 54x186mm
PD-V003B	Insulated hook blade cable knife 33x170mm
9SB-3935	Plastic tool box (390x350x90mm)

- Ideal for power plant, HVAC, automotive, military, aircraft field applications and more.

PK-2836M 1000V Insulated Metric Tool Kit



- Ideal for power plant, HVAC, automotive, military, aircraft field applications and more.



MODEL	CONTENTS
PM-911	Insulated combination plier (195mm)
PM-917	Insulated side cutter(165mm)
PM-910	Insulated wire stripping plier (160mm)
SR-V210	Insulated cable cutter 250mm (80mm ²)
HW-V110B	Insulated single open end wrench 10mm
HW-V113B	Insulated single open end wrench 13mm
HW-V114B	Insulated single open end wrench 14mm
HW-V117B	Insulated single open end wrench 17mm
HW-V119B	Insulated single open end wrench 19mm
HW-V122B	Insulated single open end wrench 22mm
HW-V210B	Insulated single box end wrench 10mm
HW-V213B	Insulated single box end wrench 13mm
HW-V214B	Insulated single box end wrench 14mm
HW-V217B	Insulated single box end wrench 17mm
HW-V219B	Insulated single box end wrench 19mm
HW-V222B	Insulated single box end wrench 22mm
SD-810-S2.5	⊖ Insulated screwdriver(2.5×75)
SD-810-S4.0	⊖ Insulated screwdriver (4.0×100)
SD-810-S5.5	⊖ Insulated screwdriver (5.5×125)
SD-810-S6.5	⊖ Insulated screwdriver (6.5×150)
SD-810-P1	⊕ Insulated screwdriver (#1×80)
SD-810-P2	⊕ Insulated screwdriver (#2×100)
SK-V752	Insulated 1/2" drive T handle 200mm
HW-V710	Insulated 1/2" drive reverse flat ratchet handle 250mm
SK-V851	Insulated 1/2" drive extension bar 125mm
SK-V852	Insulated 1/2" drive extension bar 250mm
SK-V410B	Insulated 1/2" drive socket 10mm
SK-V411B	Insulated 1/2" drive socket 11mm
SK-V412B	Insulated 1/2" drive socket 12mm
SK-V413B	Insulated 1/2" drive socket 13mm
SK-V414B	Insulated 1/2" drive socket 14mm
SK-V416B	Insulated 1/2" drive socket 16mm
SK-V417B	Insulated 1/2" drive socket 17mm
SK-V418B	Insulated 1/2" drive socket 18mm
SK-V419B	Insulated 1/2" drive socket 19mm
SK-V422B	Insulated 1/2" drive socket 22mm
SK-V424B	Insulated 1/2" drive socket 24mm
PD-V003A	Insulated straight blade cable knife 54x186mm
SR-V336	Insulated electricians scissors 160mm
MS-V001	Insulated tape 20mm×10M
HW-V610	Insulated 10" adjustable wrench
TC-736	Expert & Elegant aluminum frame tool case (486x325x159mm)
9PK-2836M-TP	Top pallet for PK-2836M
9PK-2836M-P	Pallet for PK-2836M

PRECISION TWEEZERS



TZ-202N Super Fine Tip Straight Tweezer 



• ESD safe.

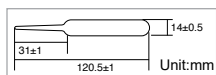

Material	Magnetic	OAL.(mm)
AISI 304	No	120.5

1PK-101T Insulated Tweezer 

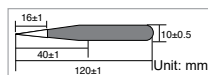

Material	Magnetic	OAL.(mm)
AISI 304	No	120

TZ-204N Fine Tip Curved Tweezer 



• ESD safe.

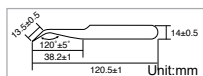

Material	Magnetic	OAL.(mm)
AISI 304	No	120.5

1PK-102T Super Fine Tip Straight Tweezer 

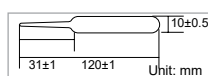

Material	Magnetic	OAL.(mm)
AISI 304	No	120

TZ-205N Fine Tip Straight Tweezer 



• ESD safe.

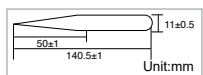

Material	Magnetic	OAL.(mm)
AISI 304	No	140.5

1PK-104T Fine Tip Curved Tweezer 

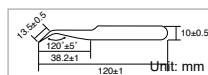

Material	Magnetic	OAL.(mm)
AISI 304	No	120

TZ-212N Extremely Fine And Sharp Tip Tweezer 



• ESD safe.

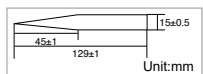

Material	Magnetic	OAL.(mm)
AISI 304	No	129

1PK-105T Fine Tip Straight Tweezer 

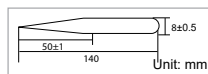

Material	Magnetic	OAL.(mm)
AISI 304	No	140

1PK-110T Cutting Tweezer

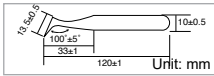

Material	Magnetic	OAL.(mm)
AISI 304	No	120

1PK-106T Universal Tweezer

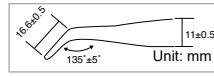

Material	Magnetic	OAL.(mm)
AISI 410	Yes	175

1PK-112T Extremely Fine And Sharp Tip Tweezer

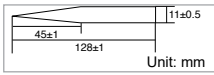

Material	Magnetic	OAL.(mm)
AISI 304	No	128

1PK-123T Heavy-Duty Tweezer

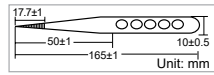

Material	Magnetic	OAL.(mm)
AISI 410	Yes	165

TZ-116 Blunt Flat Tip Tweezer

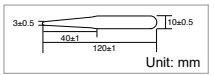
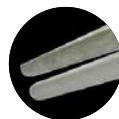

Material	Magnetic	OAL.(mm)
AISI 304	No	120

1PK-108T Reverse Action Tweezer

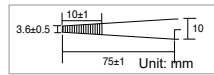

Material	Magnetic	OAL.(mm)
AISI 410	Yes	165

1PK-125T Super Fine Tip Straight Tweezer

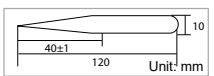

Material	Magnetic	OAL.(mm)
AISI 304	No	120

1PK-115T Long Nose Tweezer



Material	Magnetic	OAL.(mm)
AISI 410	Yes	200

SOCKET
WRENCHES
POWER TOOLS
ESD STATIC
PROTECTION
VISE TOOLS
PRECISION
TWEEZERS
MAGNIFIER
& LAMP
KNIVES
& SCISSORS
MISCELLANEOUS
INSTRUMENT
CASES
TOOL CASES
INDEX



1PK-117T / 1PK-118T / 1PK-119T Wooden Handle Tweezer



Cross Leg Soldering Tweezer

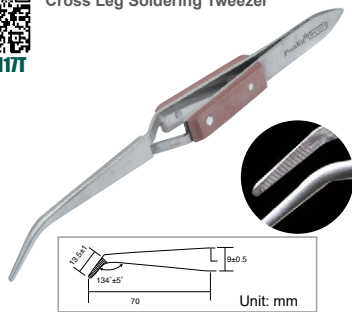

Heavy Duty Tweezer

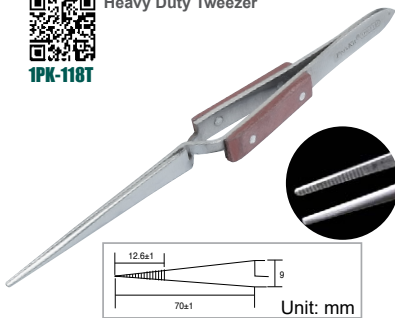

Point Tweezer

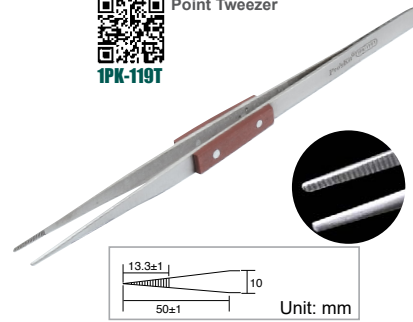

- Acid-resistant.
- Heat-resistant.

MODEL	1PK-117T	1PK-118T	1PK-119T
Material	AISI 410		
Magnetic	Yes		
OAL.(mm)	164	165	200

808-389 4 PCS Tweezer Set



OAL:115mm



OAL:110mm



OAL:120mm



OAL:116mm



- Lead free.
- Economic type.
- 4 different style stainless steel tweezers for every need.

Material	Magnetic	OAL.(mm)
AISI 430	Yes	110-120

908-T301 2 PCS Tweezer Set

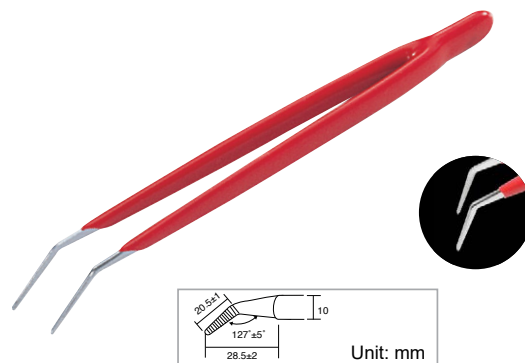
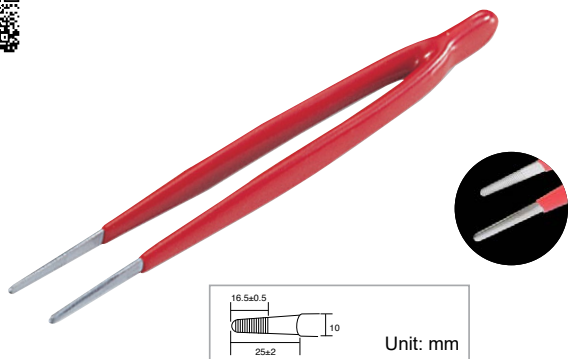

- 2 pcs economic-type tweezers with insulated coating handles.

Material	Magnetic	OAL.(mm)
AISI 430	Yes	145

TZ-300A / TZ-300B Static Dissipative Soft Tip Tweezer



TZ-300A

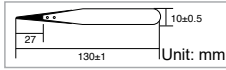

TZ-300B

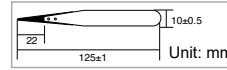

- ESD safe.
- Lead free.

MODEL	TZ-300A	TZ-300B
Material	AISI 302 / PPS-hb	
Resistance	<10 ⁹ Ω	
Replacement tip	5TZ-300A	5TZ-300B
Magnetic	No	
OAL.(mm)	130	125

TZ-100 Series Conductive Tweezer



TZ-100A

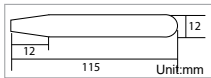

TZ-100B

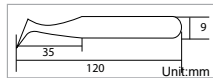

TZ-100C

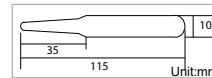

TZ-100D

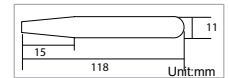

- ESD safe.

MODEL	TZ-100A	TZ-100B	TZ-100C	TZ-100D
Material	PC + Carbon fiber			
Resistance	<10 ⁹ Ω			
OAL.(mm)	115	120	115	118

TZ-121 Ceramic Tip Tweezer



- Lead free.
- 0.5 mm tip.
- Chemical-resistant.
- Heat-resistant.

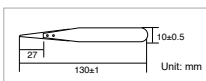

Material	Magnetic	OAL.(mm)
AISI 302 / Ceramic (Zirconia)	No	130
Replacement tip	9TZ-121-BIT	

TZ-101D/E Conductive Tweezer



TZ-101D

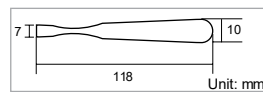

TZ-101E

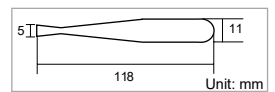

- ESD-safe.

MODEL	TZ-101D	TZ-101E
Material	PC+Carbon Fiber	
Resistance	10 ⁶ -10 ⁹ Ω	
OAL.(mm)	118	

MAGNIFIER & LAMP



MA-1010U 2 in 1 USB Magnifying LED Lamp



250 LUMEN

6000-7000K

2700-3200K

- Touch switch.
- Flexible goose neck.
- Max clamp opening 55mm.

Lens material	Magnification	Lens size	Light source	Power source
Glass	3D (1.75X)	Ø 100mm	36 LEDs	Micro USB

MA-1209LA/ MA-1209LI LED Table Clamp Magnifier Lamp



MA-1209LA MA-1209LI

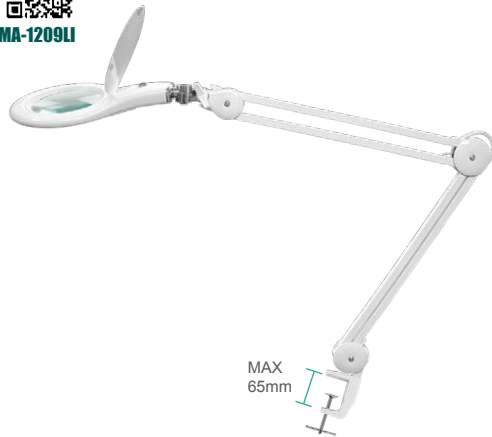

700 LUMEN

6000-7000K

- Max clamp opening 65mm.

MODEL	MA-1209LA	MA-1209LI
Voltage	120V AC	220-240V AC

Lens material	Magnification	Lens size	Light source	Power source
Glass	5D (2.25X)	Ø 127mm	56 LEDs	Wall plug

MA-1215CA/MA-1215CF Table Clamp Magnifier with Workbench Lamp



MA-1215CA MA-1215CF



900 LUMEN

6000-7000K

- Max clamp opening 65mm.

MODEL	MA-1215CA	MA-1215CF
Voltage	120V AC	220-240V AC

Lens material	Magnification	Lens size	Light source	Power source
Glass	5D (2.25X)	Ø 127mm	22W/T5 G10q	Wall plug

MA-1004A/F LED Desk Type Magnifier Lamp



650 LUMEN

6000-7000K

MODEL	MA-1004A	MA-1004F
Voltage	110-120V AC	220-240V AC
Adapter output	21V 0.35A	

Lens material	Magnification	Lens size	Light source	Power source
Glass	3D (1.75X)	127×79 mm	56 LEDs	Wall plug

MA-1013MA/MF LED Desk Type Magnifier Lamp



550 LUMEN

6000-7000K

MODEL	MA-1013MA	MA-1013MF
Voltage	110-120V AC	220-240V AC

Lens material	Magnification	Lens size	Light source	Power source
Glass	3D(1.75X) & 12D(4X)	Ø 100mm	40 LEDs	Wall plug

MA-1225CF Gooseneck Magnifier Lamp



900 LUMEN

6000-7000K

- Flexible gooseneck
- Dust-proof cover for lens protection.

MODEL	MA-1225CF
Voltage	220-240V AC

Lens material	Magnification	Lens size	Light source	Power source
Glass	5D (2.25X)	Ø 127mm	22W/T5 G10q	Wall plug

MA-025 Folding & Handheld USB LED Magnifier



- Battery not included.

Lens material	Magnification	Lens size	Light source	Power source
Acrylic	3.75X (11D) 7X (24D)	Ø 70mm/19mm	8 LEDs	USB/AAA Battery x3

MA-016 Headband Magnifier



- Multiple lens.
- Adjustable size.
- Detachable LED light device.
- Battery not included.

Lens material	Magnification	Lens size	Light source	Power source
Acrylic	1.8X/2.6X/5.8X	Ø 28mm/89x29mm	1 LED	AAA Battery x2

MA-014 8X LED Illuminated Magnifier



- Lead free.
- Portable size.
- Hinged stainless cover.

Lens material	Magnification	Lens size	Light source	Power source
Glass	30D (8X)	Ø 21mm (0.82")	1 LED	LR1130 (AG10) x 3

MA-029 Handheld LED Magnifier w/Currency Detecting Function



UV Light



6X magnifier

- Dual magnification.
- Battery not included.

Lens material	Magnification	Lens size	Light source	Power source
Acrylic Lens	2.5X (6D) 6X (20D)	Ø 70mm / Ø 19mm	8 LEDs/1 UV light	AAA Battery x 3

MA-019 3X Handheld LED Light Magnifier with Currency Detecting Function



- Lead free.
- Battery not included.

MODEL	Lens material	Magnification	Lens size	Light source	Power source
MA-019	Glass	8D (3X)	Ø 56mm	8 LEDs/1 UV	AAA Battery x 3
MA-023	Acrylic	10D (3.5X) / 76D (20X)	Ø 50mm / Ø 18mm	2 LEDs	AAA Battery x 3

MA-023 Handheld LED Light Magnifier



- Battery not included.

MA-020/MA-021/MA-022 22X/3.5X/7.5X Handheld LED Magnifier



- Lead free.
- Battery not included.

- Lead free.
- Battery not included.

- Lead free.
- Battery not included.

MODEL	Lens material	Magnification	Lens size	Light source	Power source
MA-020	Glass	16D (5X) / 13D (22X)	Ø 19mm	2 LEDs	AAA Battery x 3
MA-021		10D (3.5X)	Ø 46mm		
MA-022		26D (7.5X)	Ø 27mm	1 LED/1 UV	CR 2016 Battery x 2

KNIVES & SCISSORS



SR-336 Multi Purpose Scissors



• Special design. Wire cutter / Jar opener / Walnut clamp.

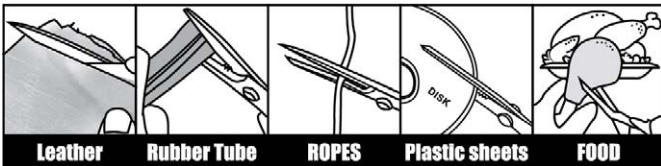

Cutting capability	MAX	Cutting capability	MAX
Aluminum sheets	0.8mm	Rubber sheets	4.0mm
Plastic sheets	1.2mm	Leather	5.0mm
Copper sheets	0.5mm	Ropes (Cotton/Nylon)	Ø10mm
Galvanized / Tin sheets	0.4mm	Aluminum / Copper wires	Ø2.5mm
Material		HRC Body	OAL (mm)
420 J2 Stainless Steel / PP+TPR		53°±2°	206

SOCKET
WRENCHES

POWER TOOLS

ESD STATIC
PROTECTION

WIRE TOOLS

PRECISION
TWEEZERS

MAGNIFIER
& LAMP

KNIVES
& SCISSORS

MISCELLANEOUS

INSTRUMENT
CASES

TOOL CASES

INDEX

SR-338 Multi-Purpose Shears



- Wire spring.
- Storage lock. Ensures user safety and convenient storage.



Cutting capability	MAX	Cutting capability	MAX
Aluminum sheets	1.0mm	Leather	5.0mm
Plastic sheets	2.0mm	Copper sheets	0.5mm
Aluminum / Copper wires	Ø2.5mm	Rubber sheets	5.0mm
Tin sheets	0.4mm	Copper stranded conductor	3C x 2mm ²
Power cables	5.5mm ²		
Material		HRC Body	OAL (mm)
420 J2 Stainless Steel / PP+TPR		53°±2°	185



SR-339 Multi Purpose Angled Scissors



- Wire spring.
- Adjustable mechanism. Handles adjustable to fit large/small hands comfortably.
- Angled design. Offset handles allow easy cutting on flat surfaces.

Cutting capability	MAX	Cutting capability	MAX
Aluminum sheets	0.8mm	Leather	5.0mm
Plastic sheets	1.2mm	Ropes (Cotton/Nylon)	Ø10mm
Aluminum / Copper wires	Ø2.5mm	Copper sheets	0.5mm
Galvanized / Tin sheets	0.4mm	Rubber sheets	4.0mm
Material		HRC Body	OAL (mm)
420 J2 Stainless Steel / PP+TPR		53°±2°	250

SR-332 All Purpose Snip



- Wire spring.

Cutting capability	MAX
Cardboard, PVC Leather, Rubber sheet	5.0mm
PVC water pipe, Cable, Plastic tube	Ø10mm
Aluminum sheet, Copper sheet	1.0mm
Steel sheet	0.5mm
Material	OAL (mm)
AISI 420 Stainless Steel / PP+TPR	165

SR-333 Micro Scissors



- Wire spring.
- Made of stainless steel to resist rust and corrosion.
- Return spring offers more smooth operation.

Cutting capability	MAX
Copper, IC, component pin	0.3mm
PVC, PET, plastic	0.2mm
Fixable flat cable	0.3mm
Material	OAL (mm)
AISI 420 / ABS+TPE	120

SR-366 Ratchet Plastic Pipe Cutter



- V-shaped blade.
- Blade quick change.
- Ratchet action.
- Replacement blade:5SR-366-B.

Material	Aluminum Alloy Steel
Cutting	max.38mm(1.5inch)
OAL (mm)	195

SR-330 All Purpose Snip



- Wire spring.

Cutting capability	MAX
Cardboard, PVC Leather, Rubber	3.0mm
Aluminum sheet, Copper sheet	1.0mm
PVC, PET, plastic	0.2mm
Fixable flat cable	0.3mm
Material	OAL (mm)
AISI 410 / PP+TPR	165

8PK-SR007 All Purpose Snip



- Wire spring.

Cutting capability	MAX
Cardboard, PVC Leather, Rubber	3.0mm
Aluminum sheet, Copper sheet	1.0mm
PVC, PET, Plastic	0.2mm
Fixable flat cable	0.3mm
Carpet	10.0mm
Material	OAL (mm)
SUS 420J2 / PP+TPR	200

DK-2047N Electricians Scissors



- Scraper and file on side edge of blade.

Material	AISI 420 / Nylon+Filber
Cutting	up to AWG 16 solid wire and AWG 12 stranded wire
Stripping wire	AWG 18 and 22
OAL (mm)	145

SOCKET
WRENCHES

POWER TOOLS

ESD STATIC
PROTECTION

WIRE TOOLS

PRECISION
TWEEZERS

MAGNIFIER
& LAMP

KNIVES
& SCISSORS

MISCELLANEOUS

INSTRUMENT
CASES

TOOL CASES

INDEX

SW-201 Multi-Purpose Pruning Saw

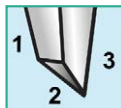

- Japanese steel. High impulse hardened edge.
- Impulse hardened teeth.
- 3-Edge grinding teeth. Provides efficient cutting.
- Replacement blade: 5SW-201

Material	SK85 / ABS+TPR
HRC	50°±2°
Thickness/Length	0.7mm/250mm
Tpi/Ppi	11/12
OAL (mm)	390

PD-992 Electrician's Knife



Blade guard

- The V-shaped groove of the cover is specially designed to position wire firmly to prevent sliding while peeling the sheathed wire.

Material	4034 Stainless Steel / Nylon
HRC	58°±2°
V-shaped groove	Cable O.D. Ø3~30mm
OAL (mm)	190

PD-998 Electrician's Knife



- PVC, PE cable stripping.
- High quality stainless steel, large curved hawk bill blade offer durability and artistic appearance.

Material	OAL (mm)
ABS / 3 Cr 13	190

DK-2112 Auto Loading Utility Knife



Blade storage

- Automatic blade reload for effortless and quick blade changes.
- Convenient blade storage compartment holds up to 6pcs blades (blades included).
- Replacement blade: 5DK-2112-B (10pcs)

Material	OAL (mm)
Zinc Alloy+TPR / SK5	165

PD-515 Wallpaper Snap Knife



- Hardening blade. Sharp and durable.
- Ultra thin blade. Glides through paper effortlessly without tearing or dragging.



Flexible blade



Replacement blade: 5PD-515-B(20pcs)

Material	OAL (mm)
ABS+PP / SK4	150

DK-2039 Utility Knife



- Blade in thickness: 0.5mm.
- Includes 3 blades.



Replacement blade: DK-2039-B10 (10pcs)

Material	OAL (mm)
ABS+TPR / SK4	170

PD-398 14PCS Aluminum Handle Knife Kit



CONTENTS

- 13pcs SK5 blades
- 1pc aluminum handle
- 1pc plastic case
- Size: 151x82x25 mm

PD-395A 30PCS Deluxe Hobby Knife Kit



Magnetic strip

- Lead free

CONTENTS

- | | |
|------------------------------|--------------------------|
| 3pcs TRP+PP non-slip handles | 19pcs SK5 cutting blades |
| 2pcs awl blades | 1pc tweezer |
| 4pcs shovel blades | 1pc grindstone |
| 1pc dual color TPR+PP case | Size: 205x132x45mm |

8PK-394A/8PK-394B/PD-394A Precision Knife



8PK-394A Replacement blade: 508-394A-B (10pcs)



8PK-394B Replacement blade: 508-394B-B (10pcs)



PD-394A Replacement blade: 5PD-394A-B (10pcs)

- Surgically sharp knives with high-impact plastic safety cap.

Model	8PK-394A	8PK-394B	PD-394A
Material	Aluminum handle / SK5 blades		
Handle diameter	Ø8mm	Ø11mm	Ø8mm
OAL (mm)	145	150	145

PD-510 Quick Point Snap-Blade Knife



- Lead free.
- Includes 2 blades.
- Locking slide.
- Replacement blade: 5PD-510-B (10pcs)

Material	OAL (mm)
ABS / SK5	140

PD-513 Utility Knife



- Lead free.

Material	OAL (mm)
ABS / SK4	155

MISCELLANEOUS



MS-C002 Mini Vacuum & Blowing Cleaner



Speed	Torque	Output	Power	Body size
25,000 rpm	26 g-cm	5.15W 1.83A	DC 6.0V (AA 1.5Vx4 pcs)	45 × 130 × 90

MS-C001 Mini Vacuum Cleaner



- Cleans keyboards, printer, photographic equipment, audio/visual equipment and all office electronics.

Material	Power	OAL (mm)
Polypropylene	DC 6.0V (AA 1.5V x 4pcs)	130 x 43 x 55

MS-C005I Dust Blowing & Vacuum Cleaner



Reusing washable dust bag.

- 2 in 1 : Vacuum cleaner & Blowing cleaner
- Large power trigger with conveniently located lock-on button.

Voltage	230V / 50Hz
Power	220-240V 650 W
No load speed	approx 16000 rpm
Air voltage	2.3m ³ /min
Accessories	1 x Air flow tube, 1x Dust bag
Dimensions	195 x 195 x 175mm
Weight	50 oz (1.4Kg)

MS-153A / MS-153C Bulb Blower



MS-153A



Air valve made by copper with chrome plating

Copper nozzle



MS-153C



Air valve made by copper with chrome plating

Long mouthpiece and brush

MODEL	Material	Nozzle material	Nozzle size	Air valve Material	Pump capacity	OAL (mm)
MS-153A	PVC	Copper with chrome plating	Ø2.2 × 14mm	Copper with chrome plating	50 ml	Ø42 × 94
MS-153C		ABS	Ø5.0 × 30mm		110 ml	Ø56 × 140

PD-151 6" Electronic Caliper



- Thumb wheel for accuracy and ease with 4 measurement: inside, outside, depth and step.

Inside dimension measurement

Material	Range	Accuracy	Resolution	Power
Stainless steel	0~150mm / 0~6"	±0.02mm/0.001"(<100mm) ±0.03mm/0.001"(>100mm)	0.01mm / 0.0005"	LR44 (1.5V) x1 pcs

PD-161-C Multipurpose Laser Level Measuring Tape Ruler



Laser mode	Horizontal, vertical, cross line	Measuring tape length	2.5m/8ft (both metric and imperial standard)
Optimum distance	1.5m~2m	Standard ruler length	15cm/6" (both metric and imperial standard)
Laser Class	ClassIIIA (<5mW)	Power	1.5V LR44 x 3
Laser wavelength	630nm~680nm	Weight	180g
Bubble level	3pcs- horizontal, vertical, 45°	Dimension	191 x 62 x 28 mm

DK-2032 / DK-2033N / DK-2034N Fish Tape



DK-2032



DK-2033N



DK-2034N



MODEL	DK-2032	DK-2033N	DK-2034N
Container size	Ø 214 × 27mm	Ø 305 × 42mm	Ø 305 × 42mm
Steel tape size	15.2M x 3.2 x 1.6mm (50ft x 1/8" x 1/26")	30.5M x 3.2 x 1.6mm (100ft x 1/8" x 1/26")	61.0M x 3.2 x 1.6mm (200ft x 1/8" x 1/26")

DK-2060SET / DK-2040 / DK-2041 / DK-2042 Measuring Tape



DK-2060SET
(12pcs/SET)



DK-2040



DK-2041



DK-2042

- Magnetic end-hook.
- Anti-slip and shockproof robust case.
- Hi-rel power tape.
- Auto stop.



Magnetic End-Hook



MODEL	DK-2060SET	DK-2040	DK-2041	DK-2042
L (Max.)	3M/10ft	3M/10ft	5M/16ft	7.5M/25ft
W (Max.)	16mm	16mm	19mm	25mm
Thickness			0.11 mm	
Case			ABS+PVC	

MS-B126 Battery Operated SMD Vacuum Pick-Up Tool 



- ESD safe.
- Built-in ultra-small vacuum pump.

Ø4mm suction cup	Ø6mm suction cup	Ø10mm suction cup	Power	Weight	Dimension
10g	35g	80g	1.5V AAA x 1pc	27g	160 x 23 x 19mm

MS-121 Vacuum Pick-Up Tool



- ESD safe.
- Lead free.
- Lightweight, portable.

Replacement caps	Dimension
9122-010 (3pcs/bag) Ø4, 6, 10mm	Ø10x132mm

8PK-610 /PD-610 PLCC Extractor 



- A spring assisted chip carrier extraction tool, specially designed for the safe removal of PLCC's from sockets without damage to component parts.

Material	OAL (mm)
AISI 410 + POM	100x50

Material	OAL (mm)
AISI 304 + POM	100x50

908-609 IC Extractor 

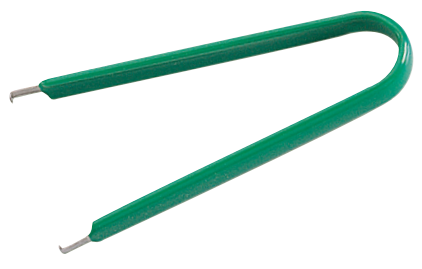

- Stainless steel construction for removing dual in-line IC packages. (Insulated vinyl grip.)

Material	OAL (mm)
AISI 420J + PVC	105

MS-323 Telescopic Magnetic Pick-Up Tool

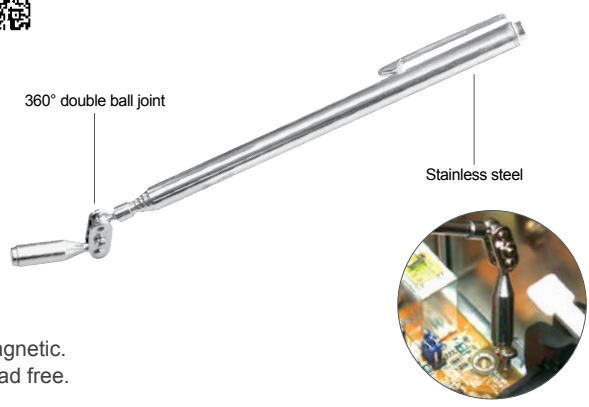

- Magnetic.
- Lead free.

Maximum pick-up	Extension length
454g (1lb)	178~582mm

1PK-390G Inspection Mirror



360° double ball joint

- Lead free.
- Visual inspection of hidden areas.
- Double ball joint links swivel mirrors for viewing to 360°.
- Non-rotating inner hex rods.

Lens size	OAL (mm)
50x90mm (2"x3-1/2")	216 ~ 490 (8-1/2"~19-1/4")

MS-391 Inspection Mirror

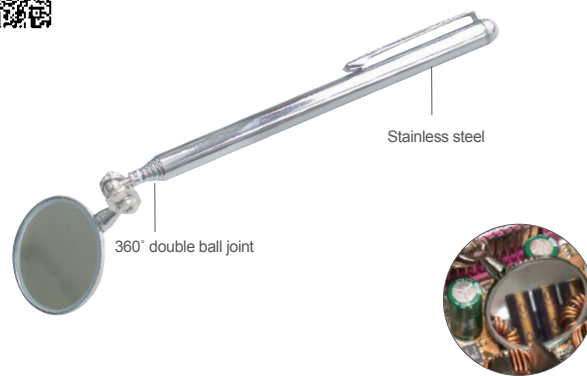

Stainless steel

360° double ball joint

Lens size	Extension length
Ø30mm (1-1/5")	178~505 (7" ~19-7/8")

OP-E351 Breadboard Accessory



- 350pcs of 22 AWG solid wires.
- Pre-cut, pre stripped and pre-formed on each end.
- Variety of colors and completely reusable.

Case size (mm)	Content
178 x 90 x 28	14 lengths x 25 pcs each (2, 5, 7, 10, 12, 15, 17, 20, 22, 25, 50, 75, 100 and 125mm)

BX-4112N Round Hole Breadboard

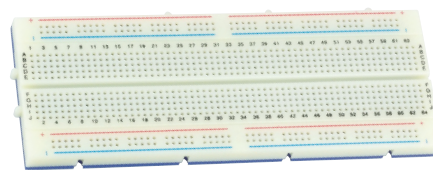

- Lead free.
- Wearproof material made of ABS & copper with good flexibility and electric conductivity.

Dimension (mm)	Tie points
64 x 171	840

BX-4123 / BX-4135 Round Hole Breadboard



- Lead free.
- Expandable by combining several boards together to meet your different requirement.
- Wearproof material made of ABS & copper with good flexibility and electric conductivity.
- Used as a simulated layout for R&D and students.

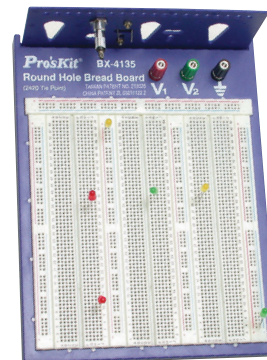
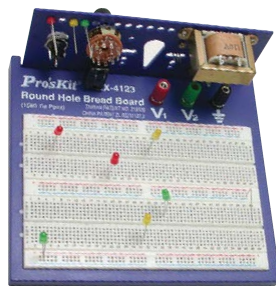

MODEL	BX-4123	BX-4135
Tip points	1580	2420
Dimension (mm)	190 x 175 x 21	245 x 185 x 20

1PK-3171 / 1PK-317N Spring Hook

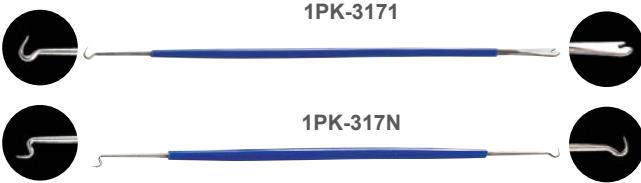

- Lead free.
- Suitable for OA field service.

Material	OAL (mm)
AISI 410 + PVC	205

8PK-605A 5 PCS Needle File Set

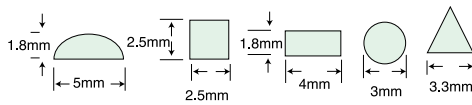

Material	HRC	Cut length	Handle O.D.	OAL (mm)
Bearingsteel	60°	75mm	Ø 5mm	170

FL-528 1W LED Head Light



- 4 angles adjustment.
- High/Low/Flash modes.
- 80,000 hours life.

Lamp material	Light source	Illumination	Battery	Dimension (mm)
ABS	1W white micro LED	60 Lumens	3 x 1.5V AAA	73 x 45 x 65

1PK-3178 4 PCS Probe Set



- Lead free.

Material	OAL (mm)
AISI 410	Straight:145 Angled:140

8PK-605L 5 PCS Needle File Set

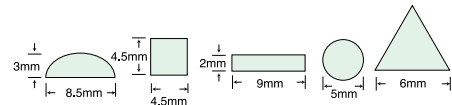

Material	HRC	Cut length	Handle O.D.	OAL (mm)
Bearingsteel	60°	85mm	Ø 7mm	180

MS-526 12-in-1 Multi-Tool



- Wire spring.
- Serrated tip.
- Rugged stainless steel construction, corrosion-resistant.

Material	HRC Body	Application	OAL (mm)
2Cr13	45°±3°	Pliers, Scissors, Saw, Philips screwdriver, Bottle opener, Can opener, Knife, Flat file, Flat screwdriver, Awl, LED+flash light	155

MS-V308 Hook and Loop Cable Ties



- Reusable devil felt
- Quick binding & removal
- 15pcs colorful combination pack

Material	OAL (mm)
Nylon /P.P	12 x 200

8PK-H081 Automatic Center Punch

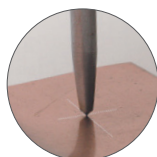

- Lead free.

High speed steel (HSS)

Tip material	OAL (mm)
HSS	133

8PK-220 Magnetizer Demagnetizer



- Magnetic.
- Ideal for the general magnetizer demagnetizer of small hand tool i.e screwdriver, hexagon keys.

Material	Dimension (mm)	Weight
ABS+Ferrite magnet	53x52x29	Approx. 80g

MS-329 Push-button Pick-up Tool



Open the jaws

- 600mm flexible stem with a small set of jaws at one end.
- Ideal for home, shop, garage, work place etc.

MS-9328 3D Printer Palette Knives



Material	Size	Handle	OAL (mm)
Stainless steel	3"	PP+TPR	208

FL-516 9 LED Flashlight



- Sturdy anodized aluminum construction, sealed at both ends with high grade rubber O-rings, water repellent and 1M drop protection.
- LEDs last up to 100,000 hours.

Material	Light source	Battery	OAL (mm)
Aluminum	9pcs White LEDs	1.5V AAA x 3pcs (Not included)	ø27 x 92

PM-386 Cable Tie Removal Tool



NEW



- For cutting various nylon cable ties, straps, soft bundled materials.
- Safe removal without damaging / scratching bundled objects.
- Simply works in limited space & cuts knot with a flat surface.

Material	Application	OAL (mm)
S45C / PVC	Nylon cable ties, straps, soft bundled materials.	170

CP-382 Cable Tie Gun



- Neatly cuts end of cable tie off.
- Adjustable tension control.

Material	HRC	Application	OAL (mm)
Aluminum / S45C	Cutter 48°±2°	Cable tie from 3/32"~3/16"(2.2~4.8mm) and thickness up to 1.6mm	160

CP-395 3 In 1 Heavy Duty Staple Gun



- Door Type • U Type • T Type



- Adjustable pressure.
- 600pcs staples included.

Body Material	Low carbon steel ST12
Surface treatment	Chrome plated
Dimension	158 x 137 x 30mm
Net weight	540g

MS-710 Anti-Fog UV Protective Glasses



Size adjustment

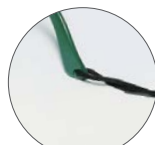

Hanging hole

- UV 400 Resistant
- Anti-Scratch
- Anti-Fog

Material	Nylon
Lens material	Polycarbonate
Product length (Temples folded)	147mm
Product width (Glasses included)	56.5mm
Temple length	117mm(MAX.)
Lens size	140 x 55mm
Lens thickness	2.0mm
Weight	34g

MS-161 Heavy-Duty Suction Cup



ABS Handle

TPU Sucker



- Ideal for open iMac, iPad & glass-sheathed laptop displays.
- Capacity up to 10kg (22lbs).

Size
Ø56mm x 68mm

MS-018 Leak Proof Dispenser Pump Bottle



- Portable leak proof construction.
- Bottle scale indication.
- Anti dumping of cone design.

Material	Capacity
PE	180ml

PD-374 Hobby Vise

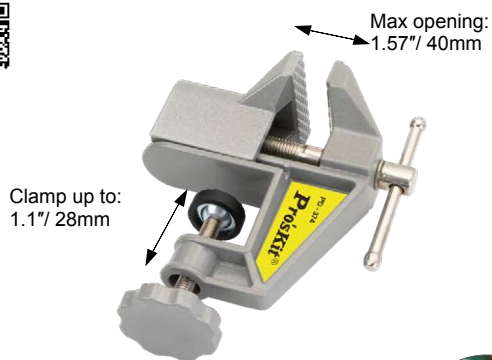

Max opening:
1.57"/40mm

Clamp up to:
1.1"/28mm



- A small hobbyist's vise.
- Jaw width: 2.4"/60mm.
- Aluminum die-cast construction.

MS-035 Flux Bottle



Ø0.9 x 34mm

- Dispenses flux evenly with a fine tipped needle.

Material	OAL (mm)
PE	Ø37x150

MS-004/ 006 / 008 Liquid Dispenser Bottles



MS-004

MS-006

MS-008



- Lead free.
- Polyethylene bottles are not chemically reactive.
- Purity pump to prevent backwash of contaminants into container.

MODEL	MS-004	MS-006	MS-008
Description	4 oz/114 ml	6 oz/170 ml	8 oz/227 ml

PD-372 Mini Vise



Max opening : 25mm

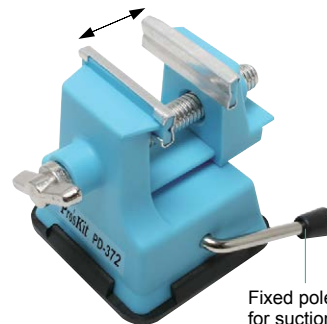

Fixed pole
for suction pad

- Light and durable polypropylene construction.
- Zinc plated handle, screw jaws and locking bolt.
- Ideal for small work, such as hobby, craft, modeling items and more.

PD-376 Multi-Angle Swivel-Actions Vacu-Vise

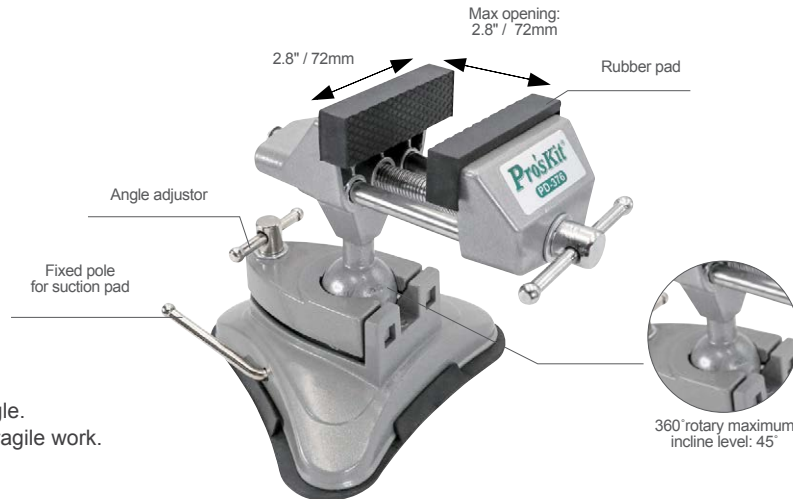

- Swivels 360° and tilts 90° to desired angle.
- Equipped with slide-on rubber jaw for fragile work.
- 6 1/4" (158mm) triangular base.
- Aluminum die-cast construction.

PD-2616 / PD-2609 / PD-2612 / PD-2606 / PD-2607 Hammer



PD-2616



PD-2609



PD-2612



PD-2606



PD-2607



MODEL	PD-2616	PD-2609	PD-2612	PD-2606	PD-2607
Material	FB +PP(TPR) / S45C	PIPE (PP+TPR) / S45C	PIPE (PVC) / S45C	FB +PP(TPR) / S45C	FB +PP(TPR) / S45C
Weight	450g	340g	340g	690g	630g
OAL (mm)	298	250	250	330	300

INSTRUMENT CASES



TC-285 / TC-286 / TC-287 Heavy-Duty Waterproof Case



TC-285



TC-286



TC-287



Great water repellent



Pressure relief valve



Shockproof protection



Large capacity

Model	TC-285	TC-286	TC-287
Material	Polypropylene	Polypropylene	Polypropylene
Load capacity	20kg	15kg	15kg
O.D.	460x360x178mm	340x300x150mm	270x245x145mm
I.D.	435x290x165mm	312x236x145mm	245x195x135mm
Lid Height	45mm	40mm	35mm
Box Height	120mm	105mm	100mm
Weight(Foam included))	3.9kg	2.1kg	1.2kg

SB-1418 / SB-1718 / SB-1918 Strengthening Multi-Function Toolbox with Removable Tote Tray



SB-1418



SB-1718



SB-1918



Ultra Durable



Double layer



Clear lid organizer



Padlock eye



Reinforce RIB

Model	SB-1418	SB-1718	SB-1918
Material	Polypropylene	Polypropylene	Polypropylene
Load capacity	10kg	15kg	25kg
Dimension(O.D.)	350x200x165mm (14x8x7inch)	420x230x200mm (17x9x8inch)	470x230x220mm (19x9x8.6inch)

SB-510 21" 3-Layer Folding Multi-Function Toolbox



NEW



Material	Load capacity	Dimension(O.D.)
Polypropylene	30kg	510x280x255mm

SB-3218 Multi-Function Toolbox with Removable Tote Tray

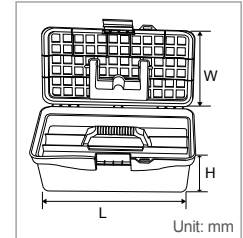
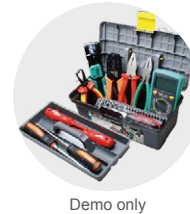

Material	Load capacity	Dimension(O.D.)
Polypropylene	5kg	315x175x130mm

SB-2918 Multi-Function Tool Box with Storage Tray

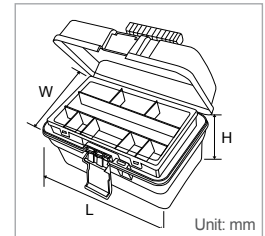

Material	Load capacity	Dimension(O.D.)
Polypropylene	5kg	290x175x175mm

SB-3428SB Service Case



- Well-divided sections for various small components.
- Integrated handle and two locks for easy carrying.

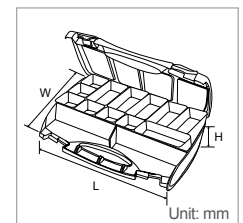

Material	Dimension (LxWxH)
Polypropylene + Polystyrene	340x280x80mm

SB-2419 Storage Box



- Tight seal prevents mixing of small components when closed.

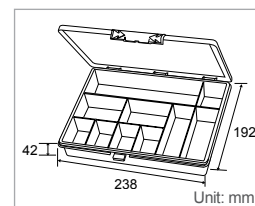

Material	Dimension (LxWxH)
Polypropylene	238x192x42mm

SB-1592 Component Storage Box



103-132C Utility Component Storage Box

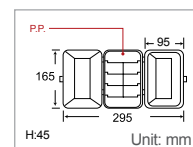

Material	Dimension (LxWxH)
Polypropylene	145x92x40mm

Material	Dimension (LxWxH)
Polypropylene	165x95x45mm

SB-1007K Multi-Purpose Box

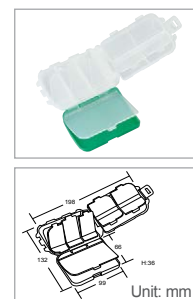

- Non-toxic.

Material	Dimension (LxWxH)
Polypropylene	99x66x36mm

103-132D Utility Component Storage Box

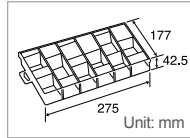

Material	Dimension (LxWxH)	Divider type	Optional divider
Polypropylene	275x177x42.5mm	Removable	503-132D-P (15 pcs/bag)

203-132E Utility Component Storage Box

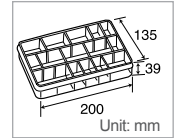

Material	Dimension (LxWxH)	Divider type	Optional divider
Polypropylene	200x135x39mm	Removable	503-132E-D12 (12 pcs/bag)

203-132F Utility Component Storage Box

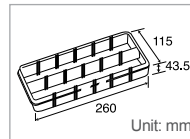

Material	Dimension (LxWxH)	Divider type	Optional divider
Polypropylene	260x115x43.5mm	Removable	503-132F-D10 (10 pcs/bag)

203-132H Multi-Purpose Case

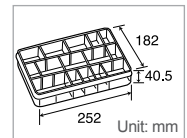

Material	Dimension (LxWxH)	Divider type	Optional divider
Polypropylene	252x182x40.5mm	Removable	503-132E-D12 (12 pcs/bag)

203-132G Utility Component Storage Box

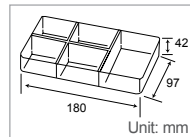

Material	Dimension (LxWxH)	Divider type
Polypropylene	180x97x42mm	Fixed

203-132I Multi-Purpose Case

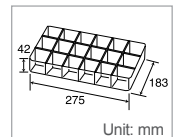

Material	Dimension (LxWxH)	Divider type
Polypropylene	275x183x42mm	Fixed

903-132 Utility Component Storage Box

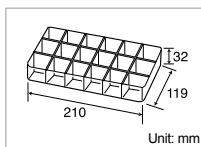

Material	Dimension (LxWxH)	Divider type
Polypropylene	210x119x32mm	Fixed

903-133S Utility Component Storage Box

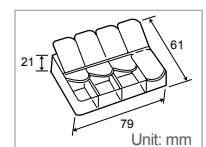

Material	Dimension (LxWxH)
Polypropylene	79x61x21mm

TOOL CASES



TC-756 Deluxe Aluminium Frame Tool Case W/1 Pallet



- Grip handle max load: 15Kg.
- Case max load: 80Kg.

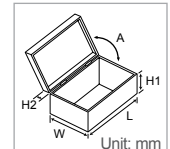
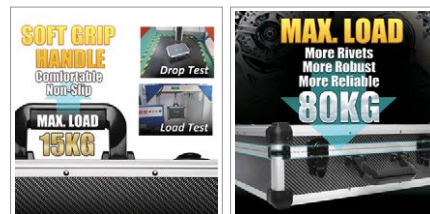

Material	Size	L	W	H1	H2	A
Frame: Aluminium	O.D (mm)	458	330	100	50	90°
	I.D (mm)	440	310	95	40	

8PK-750N Aluminium Frame Tool Case W/1 Pallet



- Complete with one removable pallet and removable interior dividers.
- Lining and partitions: EVA.

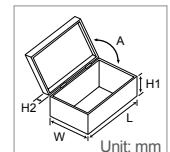
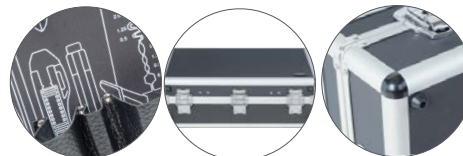

Material	Size	L	W	H1	H2	A
Frame: Aluminium	O.D (mm)	458	330	90	60	97°
	I.D (mm)	434	308	82	53	

TC-311 Heavy-Duty ABS Case With Wheels And Telescoping Handle



Key locks for maximum security



Standard equipment for easy opening and closing

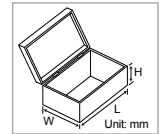

Material	L	W	H
ABS	456mm	335mm	190mm

TC-736 Expert & Elegant Aluminium Frame Tool Case W/2 Pallets

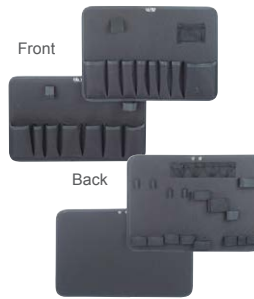

Front

Back



Standard equipment for easy opening and closing.

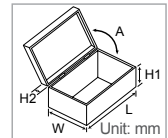

Material	Size	L	W	H1	H2	A
Frame: Aluminium	O.D (mm)	486	325	92	67	85°
	I.D (mm)	466	300	82	56	

TC-850 ABS Carrying Tool Case W/2 Pallets

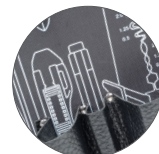

Bag with rivet design, more durable



Key locks for maximum security

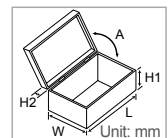

Material	Size	L	W	H1	H2	A
ABS	O.D (mm)	435	310	80	65	105°
	I.D (mm)	420	293	70	60	

TC-755 Aluminium Frame 3 Drawer Case



- Made of rugged plastic for strength and durability.

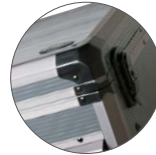

Heavy duty metal protective corners



Ball-bearing slides make drawer easy to open and close tightly

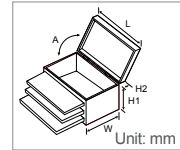

Material	Size	L	W	H1	H2	A
Frame: Aluminium	O.D (mm)	485	260	280	53	90°
	I.D (mm)	465	242	260	40	
	I.D(Drawer) (mm)	397	220	50	-	

9PK-730N Aluminium Frame Tool Case W/1 Pallet



- Includes one removable pallet and adjustable interior dividers.
- Lining and partitions made of EVA.



Bag with rivet design, more durable



Key locks for maximum security

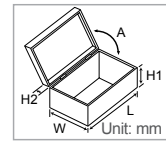

Material	Size	L	W	H1	H2	A
Frame: Aluminium	O.D (mm)	458	330	101	49	97°
	I.D (mm)	438	312	95	41	

TC-2009 ABS Carrying Tool Case W/1 Pallet



Deluxe die-cast chrome plating



Key locks for maximum security



Heavy duty metal protective corners

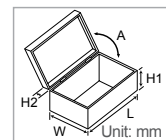

Material	Size	L	W	H1	H2	A
ABS	O.D (mm)	463	331	96	75	98°
	I.D (mm)	453	323	90	67	

9PK-710P Deluxe Tool Case W/2 Pallets



- With PK-710K pallets x2.

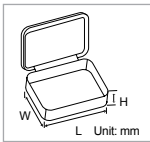

Material	L	W	H
PU leather	330mm	250mm	110mm

ST-4029 Multi-Purpose Tool Bag



- 2-in-1 design: open mouth and covered pouch.

Material	Size	Load capacity	Water repellent
600D Polyester	400X90X275mm	15kg	Yes

ST-12B Tool Bag



- 4 inner layers.
- Water repellent.

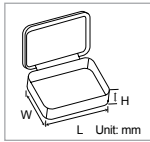

Material	L	W	H
600D polyester	400mm	275mm	90mm

ST-2012H Soft Side Tool Pouch



- Includes a universal tool belt system.

Material	L	W	H
600D polyester	305mm	235mm	95mm

ST-13S / 9ST-23 / 9ST-33 / 9ST-43 Tool Bag



ST-13S

Size:380x300x55mm

Made of 400x300D Polyester



9ST-23

Size:340x222.5x60mm



9ST-33

Size:255x180x50mm



9ST-43

Size:207x130x35mm





ST-5309 14" Deluxe Tool Bag

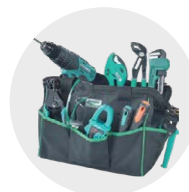

Demo only

- Shoulder strap.
- High-density webbing.

Material	Size	Load capacity	Water repellent
600D Polyester	330 x 225 x 240mm	30kg	Yes

ST-5301 20" Heavy-Duty with Wheels and Telescoping Handle



Demo only



- Heavy-duty wheel.
- Shoulder strap.
- High-density webbing.
- 16 pockets with 4 mesh bags.

Material	Size	Load capacity	Water repellent
600D Polyester	560 x 270 x 300mm	30kg	Yes

ST-5302 16" Heavy Duty Tool Bag

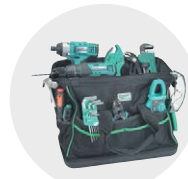

Demo only

- 14 pockets with 4 mesh bags for convenient tool organization.
- Wide open mouth design.
- Shoulder strap.
- High-density webbing.

Material	Size	Load capacity	Water repellent
600D Polyester	410 x 230 x 300mm	30kg	Yes

ST-5310 14" Deluxe Tool Bag



Demo only

- 7 pockets with 5 compartments for convenient tool organization.
- Wide open mouth design.
- Shoulder strap.
- High-density webbing.

Material	Size	Load capacity	Water repellent
600D Polyester	330 x 225 x 240mm	30kg	Yes

ST-308 Multi-Function Tool Backpack



- Wide open mouth design.
- Shoulder strap.
- High-density webbing.

Material	Size	Load capacity	Water repellent
1680D oxford fabric	320 x 180 x 400mm	20kg	Yes

ST-5102 Multi Purpose Tool Pouch



Demo only

Material	Size	Load capacity	Water repellent
600D Polyester	250 x 250 x 170mm	5kg	Yes

ST-5105 Multi Purpose Tool Pouch



Demo only

Material	Size	Load capacity	Water repellent
600D Polyester	200 x 160 x 250mm	5kg	Yes

ST-5204 Tool Pouch



Demo only

Material	Size	Load capacity	Water repellent
600D Polyester	115 x 70 x 140mm	5kg	Yes

ST-5208 General Purpose Tool Pouch



Demo only

Material	Size	Load capacity	Water repellent
600D Polyester	165 x 290 x 50mm	4kg	Yes

ST-5502/ ST-5503/ ST-5504 Tool Belt



ST-5502



ST-5503



ST-5504



Demo only



Model	ST-5502	ST-5503	ST-5504
Material		Polyester	
Loading capacity	15kg	10kg	15kg
Dimension	Width: 7cm / Length: 145mm	Width: 3.5cm / Length: 115mm	Width: 5cm / Length: 145mm

Model No	Packing	QTY/CTN	C.O.O	M.O.Q.	Page
103					
103-132C	Color Label Shrink	120	TW	120	219
103-132D	Color Label Shrink	54	TW	54	220
194					
19400-M3	Blister Card	300	TW	300	145
19400-M3.5	Blister Card	300	TW	300	145
19400-M4	Blister Card	300	TW	300	145
19400-M4.5	Blister Card	300	TW	300	145
19400-M5	Blister Card	300	TW	300	145
19400-M5.5	Blister Card	300	TW	300	145
19400-M6	Blister Card	300	TW	180	145
1PK					
1PK-034NA	Double Blister Card	300	SH	300	157
1PK-034NB	Double Blister Card	300	SH	300	157
1PK-034NC	Double Blister Card	300	SH	300	157
1PK-034ND	Double Blister Card	300	SH	300	157
1PK-034ND	Double Blister Card	300	SH	300	157
1PK-034NE	Double Blister Card	300	SH	300	157
1PK-034NF	Double Blister Card	300	SH	300	157
1PK-034NG	Double Blister Card	300	SH	300	157
1PK-034NH	Double Blister Card	300	SH	300	157
1PK-036S	Blister Card	144	SH	144	120
1PK-037S	Blister Card	144	SH	144	120
1PK-046S	Blister Card	144	SH	144	120
1PK-051DS	Blister Card	24	SH	24	125
1PK-052	Blister Card	96	SH	96	126
1PK-052DS	Blister Card	72	SH	72	125
1PK-055S	Blister Card	144	SH	144	120
1PK-066N	Blister Card	96	SH	96	116
1PK-067	Blister Card	96	SH	96	126
1PK-067DS	Blister Card	72	SH	72	125
1PK-101-E	Blister Card	144	TW	144	114
1PK-101T	Blister Card	300	TW	300	191
1PK-102-E	Blister Card	144	TW	144	115
1PK-102T	Blister Card	300	TW	300	115
1PK-104-E	Blister Card	144	TW	144	115
1PK-104T	Blister Card	300	TW	300	191
1PK-105-E	Blister Card	144	TW	144	115
1PK-105T	Blister Card	300	TW	300	191
1PK-106T	Blister Card	300	TW	300	192
1PK-108T	Blister Card	300	TW	300	192
1PK-110T	Blister Card	300	TW	300	192

Model No	Packing	QTY/CTN	C.O.O	M.O.Q.	Page
1PK-112T	Blister Card	300	TW	300	192
1PK-115T	Blister Card	300	TW	300	192
1PK-117T	Blister Card	300	TW	300	193
1PK-118T	Blister Card	300	TW	300	193
1PK-119T	Blister Card	300	TW	300	193
1PK-123T	Blister Card	300	TW	300	192
1PK-125T	Blister Card	300	TW	300	192
1PK-201	Blister Card	48	TW	48	149
1PK-202A	Blister Card	48	TW	48	151
1PK-202B	Blister Card	48	TW	48	151
1PK-209	Blister Card	144	TW	144	114
1PK-211	Blister Card	144	TW	144	114
1PK-258A	Blister Card	144	SH	144	117
1PK-25P-CE	Blister Card	144	TW	144	115
1PK-25P-E	Blister Card	144	TW	144	114
1PK-3001E	Blister Card	144	TW	144	133
1PK-3002E	Blister Card	144	TW	144	133
1PK-3003D1	Blister Card	120	TW	120	106
1PK-3003D10	Blister Card	120	TW	120	106
1PK-3003D11	Blister Card	120	TW	120	106
1PK-3003D12	Blister Card	120	TW	120	106
1PK-3003D14	Blister Card	120	TW	120	106
1PK-3003D16	Blister Card	120	TW	120	106
1PK-3003D2	Blister Card	120	TW	120	106
1PK-3003D21	Blister Card	120	TW	120	106
1PK-3003D3	Blister Card	120	TW	120	106
1PK-3003D36	Poly Bag	120	TW	120	106
1PK-3003D6	Blister Card	120	TW	120	106
1PK-3003D8	Blister Card	120	TW	120	106
1PK-3003D9	Blister Card	120	TW	120	106
1PK-3003F	Blister Card	20	TW	20	105
1PK-30-E	Blister Card	144	TW	144	114
1PK-3171	Blister Card	360	TW	360	210
1PK-3178	Pouch	180	TW	180	210
1PK-3179	Blister Card	144	TW	144	158
1PK-317N	Blister Card	360	TW	360	210
1PK-3616	Blister Card	100	TW	120	77
1PK-390G	Blister Card	100	TW	100	209
1PK-396A	Blister Card	144	TW	144	116
1PK-396B	Blister Card	144	TW	144	116
1PK-501A	Blister Card	144	TW	144	117
1PK-501C	Blister Card	144	TW	144	117

Model No	Packing	QTY/CTN	C.O.O	M.O.Q.	Page
1PK-501E	Blister Card	144	TW	144	117
1PK-5101	Blister Card	144	TW	144	117
1PK-5101-C	Blister Card	144	TW	144	117
1PK-5101-CE	Blister Card	144	TW	144	114
1PK-5101-E	Blister Card	144	TW	144	114
1PK-5102-E	Blister Card	144	TW	144	114
1PK-635	Color Sleeve Shrink	30	SH	30	23
1PK-705	Blister Card	200	TW	200	119
1PK-705Y	Blister Card	120	TW	144	121
1PK-706	Blister Card	120	TW	144	119
1PK-706Y	Blister Card	120	TW	144	121
1PK-709	Blister Card	96	SH	96	126
1PK-709DS	Blister Card	72	SH	72	125
1PK-709Y	Blister Card	120	TW	120	126
1PK-717	Blister Card	200	TW	200	119
1PK-9402	Pouch	60	TW	60	145
1PK-A001	Blister Card	180	TW	180	157
1PK-CT006	Blister Card	120	TW	120	104
1PK-GS003	Blister Card	100	TW	100	67
1PK-H026	Blister Card	144	SH	144	166
1PK-H028	Blister Card	48	SH	48	166
1PK-H074	Blister Card	300	TW	300	77
1PK-SC109NB	Plastic Box	40	SH	40	62
203					
203-132E	Color Label Shrink	72	TW	72	220
203-132F	Color Label Shrink	60	TW	60	220
203-132G	Color Label Shrink	120	TW	120	220
203-132H	Color Label Shrink	40	TW	40	220
203-132I	Color Label Shrink	40	TW	40	220
3PK					
3PK-NT023N	Color box	30	SH	30	30
508					
508-376E-B	Bulk	-	TW	-	99
508-376ER-B	Bulk	-	TW	-	99
5CP					
5CP-16	Bulk	-	TW	-	141
5CP-16A	Bulk	-	TW	-	141
5CP-16B	Poly bag	-	TW	-	141
5CP-16BK	Bulk	-	TW	-	141
5CP-333-B	Bulk	-	TW	-	99
5CP-342-B	Bulk	-	TW	-	99
5CP-376N-6PB	Bulk	-	TW	-	99

Model No	Packing	QTY/CTN	C.O.O	M.O.Q.	Page
5CP-376N-8PB	Bulk	-	TW	-	99
5CP-376N-BLADE	Bulk	-	TW	-	99
5CP-376JU-BLADE	Bulk	-	TW	-	99
5PK					
5PK-3140N-BIX	Bulk	-	TW	-	141
5PK-376C-BLADE	Bulk	-	TW	-	99
5PT					
5PT-1206-ADA	Inner Box	-	SH	-	173
5PT-1206-ADF	Inner Box	-	SH	-	173
5PT-1206-BAT	Color Box	-	SH	-	173
5PT-1801-ADA	Inner Box	-	SH	-	173
5PT-1801-ADF	Inner Box	-	SH	-	173
5PT-1801-BAT	Color Box	-	SH	-	173
5SI					
5SI-125T-B	Bulk	-	TW	-	79
5SI-125T-D	Bulk	-	TW	-	79
5SI-125T-SB	Bulk	-	TW	-	79
5SI-126T-7B	Bulk	-	SH	-	79
5SI-126T-7D	Bulk	-	SH	-	79
5SI-126T-8B	Bulk	-	SH	-	79
5SI-126T-8D	Bulk	-	SH	-	79
5SI-131-2C	Bulk	-	SH	-	79
5SI-131-3C	Bulk	-	SH	-	79
5SI-131-B	Bulk	-	SH	-	79
5SI-131-K	Bulk	-	SH	-	79
5SI-139-2D	Bulk	-	SH	-	79
5SI-139-3C	Bulk	-	SH	-	79
5SI-139-B	Bulk	-	SH	-	79
5SI-139-SB	Bulk	-	SH	-	79
5SI-216N-0.8D	Bulk	-	SH	-	79
5SI-216N-1.2D	Bulk	-	SH	-	79
5SI-216N-1.6D	Bulk	-	SH	-	79
5SI-216N-1C	Bulk	-	SH	-	79
5SI-216N-2.4D	Bulk	-	SH	-	79
5SI-216N-2C	Bulk	-	SH	-	79
5SI-216N-3.2D	Bulk	-	SH	-	79
5SI-216N-3C	Bulk	-	SH	-	79
5SI-216N-4C	Bulk	-	SH	-	79
5SI-216N-B	Bulk	-	SH	-	79
5SI-216N-B1.0	Bulk	-	SH	-	79
5SI-216N-BC	Bulk	-	SH	-	79
5SI-216N-I	Bulk	-	SH	-	79

Model No	Packing	QTY/CTN	C.O.O	M.O.Q.	Page
5SI-216N-K	Bulk	-	SH	-	79
5SI-259-B	Poly Bag	-	SH	-	79
5SI-259-C	Poly Bag	-	SH	-	79
5SI-259-D	Poly Bag	-	SH	-	79
5SI-259-I	Poly Bag	-	SH	-	79
5SI-259-K	Poly Bag	-	SH	-	79
608					
608-330	Blister Card	60	TW	60	129
608-369A	Blister Card	48	TW	48	136
608-369B	Blister Card	48	TW	48	136
608-369C	Blister Card	48	TW	48	136
608-384N	Blister Card	20	TW	20	110
608-391A	Color Box	20	SH	20	76
608-391B	Color Box	20	SH	20	76
608-391E	Color Box	20	SH	20	76
608-611B	Blister Card	200	TW	200	178
608-611B-6	Blister Card	200	TW	200	178
608-611C	Blister Card	200	TW	200	178
611					
61103	Poly Bag	25kg	TW	25kg	72
6PK					
6PK-214	Blister Card	30	TW	30	111
6PK-223	Blister Card	150	TW	150	135
6PK-230C	Blister Card	30	TW	30	107
6PK-230PA	Blister Card	30	TW	30	107
6PK-301E	Blister Card	30	TW	30	107
6PK-301H	Blister Card	30	TW	30	107
6PK-301N	Blister Card	30	TW	30	107
6PK-301R	Blister Card	30	TW	30	107
6PK-301S	Blister Card	30	TW	30	107
6PK-301U	Blister Card	30	TW	30	107
6PK-322	Blister Card	150	TW	150	138
6PK-330K	Color Label Shrink	10	TW	10	11
6PK-332	Blister Card	200	TW	200	138
6PK-501	Blister Card	100	TW	100	138
6PK-535	Blister Card	20	TW	20	130
6S					
6S-2	Color Box	60	TW	60	77
788					
788-PT50C5-100	Hanger Card	100bag	TW	10bag	98
788-PT50C6-100	Hanger Card	100bag	TW	10bag	98
808					

Model No	Packing	QTY/CTN	C.O.O	M.O.Q.	Page
808-080	Blister Card	100	TW	100	137
808-376C	Blister Card	60	TW	60	101
808-376H	Blister Card	45	TW	45	101
808-389	Pouch	180	TW	180	193
808-Q03-1	Bulk	1	TW	1	179
891					
89101A	Inner Box	360	TW	360	147
89101B	Inner Box	360	TW	360	147
89102A	Inner Box	240	TW	240	147
89102B	Inner Box	240	TW	240	147
89105A	Inner Box	360	TW	360	147
89105B	Inner Box	360	TW	360	147
89107A	Inner Box	240	TW	240	147
89107B	Inner Box	240	TW	240	147
89110B	Inner Box	240	TW	240	147
89113A	Inner Box	240	TW	240	147
89113B	Inner Box	240	TW	240	147
89115B	Inner Box	120	TW	120	147
89116B	Inner Box	240	TW	240	147
89117B	Inner Box	120	TW	120	147
89120B	Inner Box	240	TW	240	147
89121B	Inner Box	120	TW	120	147
894					
89400-H1.5	Inner Box	300	TW	300	146
89400-H2	Inner Box	300	TW	300	146
89400-H2.5	Inner Box	300	TW	300	146
89400-H3	Inner Box	240	TW	240	146
89400-T05H	Inner Box	300	TW	300	146
89400-T06H	Inner Box	300	TW	300	146
89400-T07H	Inner Box	300	TW	300	146
89400-T08H	Inner Box	300	TW	300	146
89400-T09H	Inner Box	300	TW	300	146
89400-T10H	Inner Box	300	TW	300	146
89400-TRI	Blister Card	200	TW	200	146
89401A	Inner Box	300	TW	300	145
89401B	Inner Box	300	TW	300	145
89402A	Inner Box	240	TW	240	145
89402B	Inner Box	240	TW	240	145
89405A	Inner Box	300	TW	300	145
89405B	Inner Box	300	TW	300	145
89407A	Inner Box	240	TW	240	145
89407A-L	Inner Box	200	TW	200	145

SOCKET
WRENCHES

POWER TOOLS

ESD STATIC
PROTECTION

WIRE TOOLS

PRECISION
TWEEZERS

MAGNETIC
& LAMP

KNIVES
& SCISSORS

MISCELLANEOUS

INSTRUMENT
CASES

TOOL CASES

INDEX

Model No	Packing	QTY/CTN	C.O.O	M.O.Q.	Page
89407B	Inner Box	240	TW	240	145
89407B-L	Inner Box	200	TW	200	145
89410A	Inner Box	240	TW	240	145
89410B	Inner Box	240	TW	240	145
89412B	Inner Box	144	TW	144	145
89413A	Inner Box	200	TW	200	145
89413B	Inner Box	200	TW	200	145
89414A	Inner Box	120	TW	120	145
89414B	Inner Box	120	TW	120	145
89416A	Inner Box	240	TW	240	145
89416B	Inner Box	240	TW	240	145
89417B	Inner Box	120	TW	120	145
8BM					
8BM-401A	Color Box	15	TW	15	179
8BM-405A	Color Box	15	TW	15	179
8BM-612A	Color Box	15	TW	15	179
8PK					
8PK-021N	Blister Card	100	TW	100	163
8PK-021NA	Blister Card	100	TW	100	163
8PK-021T	Blister Card	100	TW	100	163
8PK-022	Blister Card	144	TW	144	161
8PK-027	Blister Card	18	TW	18	162
8PK-028	Blister Card	48	TW	48	162
8PK-031A	Inner Box	1000	TW	1000	74
8PK-031B	Inner Box	1000	TW	1000	74
8PK-031C	Inner Box	1000	TW	1000	74
8PK-033D	Inner Box	120	TW	120	78
8PK-033DD	Inner Box	120	TW	120	78
8PK-033DDS	Inner Box	120	TW	120	78
8PK-033DS	Inner Box	120	TW	120	78
8PK-033E	Inner Box	120	TW	120	78
8PK-033F	Inner Box	120	TW	120	78
8PK-033J	Inner Box	80	TW	80	78
8PK-033JS	Inner Box	80	TW	80	78
8PK-033K	Inner Box	80	TW	80	78
8PK-033L	Inner Box	80	TW	80	78
8PK-033P	Inner Box	40	TW	40	78
8PK-033Q	Inner Box	40	TW	40	78
8PK-033R	Inner Box	40	TW	40	78
8PK-033ST	Color Box	30	TW	30	77
8PK-101-2	Blister Card	150	TW	150	67
8PK-101D	Blister Card	144	TW	144	113

Model No	Packing	QTY/CTN	C.O.O	M.O.Q.	Page
8PK-101K	Blister Card	144	TW	144	116
8PK-101KM	Blister Card	144	TW	144	116
8PK-102D	Blister Card	144	TW	144	113
8PK-2061	Plastic Box + Color Box	96	TW	96	157
8PK-2062	Plastic Box + Color Box	96	TW	96	157
8PK-2063	Plastic Box + Color Box	96	TW	96	157
8PK-220	Blister card	100	SH	100	211
8PK-249	Blister Card	60	TW	60	129
8PK-25PD	Blister Card	144	TW	144	113
8PK-3001D	Blister Card	144	TW	144	133
8PK-3002D	Blister Card	144	TW	144	133
8PK-301C	Blister Card	30	TW	30	107
8PK-301J	Blister Card	30	TW	30	107
8PK-30D	Blister Card	144	TW	144	113
8PK-324B	Blister Card	100	TW	100	142
8PK-325	Blister Card	60	TW	60	139
8PK-325B	Blister Card	60	TW	60	139
8PK-326	Blister Card	100	TW	100	92
8PK-362S	Blister Card	200	TW	200	77
8PK-366D	Blister Card	100	TW	100	73
8PK-366NA	Blister Card	100	TW	100	73
8PK-366N-B	Blister Card	100	TW	100	73
8PK-366N-G	Blister Card	100	TW	100	73
8PK-366N-O	Blister Card	100	TW	100	73
8PK-366N-S	Blister Card	100	TW	100	73
8PK-366N-Y	Blister Card	100	TW	100	73
8PK-371	Blister Card	60	TW	60	137
8PK-371D	Blister Card	60	TW	60	137
8PK-371DU	Blister Card	48	TW	48	137
8PK-376FN	Blister Card	60	TW	60	104
8PK-394A	Blister Card	200	TW	200	204
8PK-394B	Blister Card	200	TW	200	204
8PK-502	Blister Card	100	TW	100	139
8PK-605A	Pouch	240	SH	240	210
8PK-605L	Pouch	200	SH	200	210
8PK-610	Blister Card	200	TW	200	208
8PK-611	Blister Card	200	TW	200	178
8PK-611D	Blister Card	200	TW	200	178
8PK-611W	Blister Card	200	TW	200	178
8PK-750N	Inner Box + Color Label	4	SH	4	222
8PK-8100E	Color Box	36	TW	36	183
8PK-905	Blister Card	120	TW	120	121

Model No	Packing	QTY/CTN	C.O.O	M.O.Q.	Page
8PK-906	Blister Card	120	TW	120	121
8PK-A201A	Blister Card	30	TW	30	130
8PK-A202	Blister Card	60	TW	60	130
8PK-A203	Blister Card	60	TW	60	130
8PK-AS07-1	Color Box	50	TW	50	179
8PK-C002	Blister Card	200	TW	200	93
8PK-CT001	Blister Card	500	TW	500	135
8PK-CT006	Blister Card	60	TW	60	129
8PK-CT120	Inner Box + Color Label	5	TW	5	111
8PK-CT150	Inner Box + Color Label	5	TW	5	111
8PK-H081	Blister Card	120	TW	120	211
8PK-MA009	Blister Card	36	SH	36	93
8PK-S118A	Blister Card	40	SH	40	64
8PK-S118A-40	Blister Card	40	SH	40	64
8PK-S118B	Blister Card	40	SH	40	64
8PK-S118B-40	Blister Card	40	SH	40	64
8PK-S120NAD-40	Plastic Box	40	SH	40	63
8PK-S120NAD-60	Plastic Box	40	SH	40	63
8PK-S120NB-30	Plastic Box	40	SH	40	63
8PK-S120NB-40	Plastic Box	40	SH	40	63
8PK-S120NB-60	Plastic Box	40	SH	40	63
8PK-S120NBD-30	Plastic Box	40	SH	40	63
8PK-S120NBD-40	Plastic Box	40	SH	40	63
8PK-S120NBD-60	Plastic Box	40	SH	40	63
8PK-SC116NB	Blister Card	40	SH	40	62
8PK-SD002N	Color Box	24	TW	24	156
8PK-SD009	Blister Card	72	TW	72	150
8PK-SD009E	Blister Card	72	TW	72	150
8PK-SD016	Color Label Shrink	20	SH	20	168
8PK-SR007	Blister Card	60	TW	60	202
8PK-SR250	Color Box	10	TW	10	131
8PK-SR500	Color Box	5	TW	5	131
8S					
8S005	Poly bag	120	TW	120	78
903					
903-132	Poly Bag	120	TW	120	220
903-133S	Poly Bag	288	TW	288	220
908					
908-366A	Blister Card	100	TW	100	73
908-607	Bulk	1000	TW	500	157
908-609	Inner Box	1000	TW	500	208
908-T301	Blister Card	180	TW	180	193

Model No	Packing	QTY/CTN	C.O.O	M.O.Q.	Page
9DP					
9DP-S002	Inner box	500	SH	25	78
9H					
9H084	Poly bag	2000	TW	2000	77
9H085	Poly bag	2000	TW	2000	77
9H086	Poly bag	2000	TW	2000	77
9PK					
9PK-710P	Color Box	6	SH	6	225
9PK-730N	Color Box	2	SH	2	224
9S					
9S001	Inner Box	500	TW	500	78
9S002	Inner Box	500	TW	500	78
9SC116N-2D	Poly Bag	-	SH	-	79
9SC116N-3C	Poly Bag	-	SH	-	79
9SC116N-B	Poly Bag	-	SH	-	79
9SC116N-SB	Poly Bag	-	SH	-	79
9SD-200-I1	Inner Box	144	SH	144	144
9SD-200-I2	Inner Box	144	SH	144	144
9SD-200-M5	Inner Box	144	SH	144	144
9SD-200-M6	Inner Box	144	SH	144	144
9SD-200-T05H	Inner Box	144	SH	144	144
9SD-200-T06H	Inner Box	144	SH	144	144
9SD-200-T07H	Inner Box	144	SH	144	144
9SD-200-T08H	Inner Box	144	SH	144	144
9SD-200-T09H	Inner Box	144	SH	144	144
9SD-200-T10H	Inner Box	144	SH	144	144
9SD-200-T15H	Inner Box	144	SH	144	144
9SD-201A	Inner Box	144	SH	144	144
9SD-201B	Inner Box	144	SH	144	144
9SD-202A	Inner Box	144	SH	144	144
9SD-202B	Inner Box	144	SH	144	144
9SD-205A	Inner Box	144	SH	144	144
9SD-205B	Inner Box	144	SH	144	144
9SD-207A	Inner Box	144	SH	144	144
9SD-207B	Inner Box	144	SH	144	144
9SD-210A	Inner Box	144	SH	144	144
9SD-210B	Inner Box	144	SH	144	144
9SD-213A	Inner Box	144	SH	144	144
9SD-213B	Inner Box	144	SH	144	144
9SD-214A	Inner Box	96	SH	96	144
9SD-214B	Inner Box	96	SH	96	144
9SD-216B	Inner Box	144	SH	144	144

Model No	Packing	QTY/CTN	C.O.O	M.O.Q.	Page
9SD-217B	Inner Box	96	SH	96	144
9SD-220A	Inner Box	288	SH	288	144
9SD-220B	Inner Box	288	SH	288	144
9SD-222A	Inner Box	144	SH	144	144
9SD-222B	Inner Box	144	SH	144	144
9SN-310G	Inner Box	500	TW	500	78
9SS					
9SS-306-HT	Poly Bag	-	SH	-	58
9SS-306-SI	Poly Bag	-	SH	-	58
9SS-900-A1	Bulk	-	SH	-	79
9SS-900-A2	Bulk	-	SH	-	79
9SS-900-A3	Bulk	-	SH	-	79
9SS-900-B	Bulk	-	SH	-	79
9SS-900-C	Bulk	-	SH	-	79
9SS-900-E	Bulk	-	SH	-	79
9SS-900-H	Bulk	-	SH	-	79
9SS-900-L	Bulk	-	SH	-	79
9SS-900-O	Bulk	-	SH	-	79
9ST					
9ST-23	Poly Bag	30	SH	30	225
9ST-33	Poly Bag	40	SH	40	225
9ST-43	Poly Bag	100	SH	100	225
AS					
AS-501A	Blister Card	144	SH	144	179
AS-501B	Blister Card	144	SH	144	179
AS-501C	Blister Card	96	SH	96	179
AS-501D	Blister Card	72	SH	72	179
AS-501E	Blister Card	240	SH	240	179
AS-611	Blister Card	200	SH	200	178
AS-612F	Blister Card	200	SH	200	178
BX					
BX-4112N	Blister Card	72	SH	72	209
BX-4123	Blister Card	40	SH	40	209
BX-4135	Blister Card	30	SH	30	209
CN					
CN-PT50C6AS	Hanger Card	72set	TW	20set	98
CN-PT50C6S	Hanger Card	100bag	TW	10bag	98
CP					
CP-080E	Blister Card	60	SH	60	137
CP-108	Blister Card	120	SH	120	135
CP-148	Blister Card	96	SH	96	104
CP-151A	Blister Card	50	TW	50	109

Model No	Packing	QTY/CTN	C.O.O	M.O.Q.	Page
CP-151B	Blister Card	50	TW	50	109
CP-200R	Blister Card	30	TW	30	100
CP-236DE	Blister Card	200	TW	200	106
CP-236DE1	Blister Card	200	TW	200	106
CP-236DN	Blister Card	200	TW	200	106
CP-236DR	Blister Card	200	TW	200	106
CP-236DU	Poly Bag	200	TW	200	106
CP-246	Blister Card	48	TW	48	136
CP-251B	Blister Card	20	TW	20	109
CP-3001D	Blister Card	144	TW	144	133
CP-3002D	Blister Card	144	TW	144	133
CP-3003D45	Blister Card	300	TW	300	106
CP-3003D47	Blister Card	120	TW	120	106
CP-3006FD18	Blister Card	20	TW	20	107
CP-3006FD2	Blister Card	20	TW	20	107
CP-3006FD36	Blister Card	20	TW	20	107
CP-3006FD45	Blister Card	20	TW	20	107
CP-3006FD47	Blister Card	20	TW	20	107
CP-3006FS1	Blister Card	20	TW	20	107
CP-3006FS2	Blister Card	20	TW	20	107
CP-301G	Blister card	120	SH	120	133
CP-302G	Blister card	120	SH	120	133
CP-313	Blister Card	60	TW	60	110
CP-3140	Blister Card	72	SH	72	141
CP-3141	Blister Card	100	SH	100	142
CP-3141A	Blister Card	100	SH	100	142
CP-3145B	Blister Card	100	TW	100	142
CP-3148	Blister Card	50	TW	50	141
CP-315	Blister Card	100	TW	100	110
CP-3151	Blister Card	100	SH	100	141
CP-3152	Blister Card	100	SH	100	141
CP-327	Blister Card	60	TW	6	92
CP-328	Blister Card	100	TW	100	92
CP-333	Blister Card	60	TW	60	103
CP-335N	Blister Card	40	SH	40	99
CP-336DC	Blister Card	200	TW	200	106
CP-336DF2	Blister Card	200	TW	200	106
CP-336DG	Blister Card	200	TW	200	106
CP-336DI	Blister Card	200	TW	200	106
CP-336DJ	Blister Card	200	TW	200	106
CP-336DK4	Blister Card	200	TW	200	106
CP-336DP1	Blister Card	200	TW	200	106

SOCKET
WRENCHES

POWER TOOLS

ESD STATIC
PROTECTION

VISE TOOLS

PRECISION
TWEEZERSMAGNETIC
& LAMPKNIVES
& SCISSORS

MISCELLANEOUS

INSTRUMENT
CASES

TOOL CASES

INDEX

Model No	Packing	QTY/CTN	C.O.O	M.O.Q.	Page
CP-336DV	Blister Card	200	TW	200	106
CP-336F	Blister Card	30	TW	30	105
CP-342	Blister Card	60	TW	60	98
CP-351B	Blister Card	20	TW	20	109
CP-353	Blister Card	20	TW	20	109
CP-367A	Blister Card	60	TW	60	135
CP-369AE	Blister Card	48	SH	48	136
CP-369BE	Blister Card	48	SH	48	136
CP-369CE	Blister Card	48	SH	48	136
CP-371	Blister Card	30	TW	30	105
CP-373	Blister Card	45	TW	45	103
CP-376AR	Blister Card	45	TW	45	97
CP-376CN	Blister Card	50	SH	50	104
CP-376D	Blister Card	20	TW	20	102
CP-376E	Blister Card	60	SH	60	104
CP-376ER	Blister Card	20	TW	20	102
CP-376K	Blister Card	30	TW	30	100
CP-376KX	Blister Card	40	SH	40	104
CP-376M	Blister Card	20	TW	20	102
CP-376N	Blister Card	20	TW	20	98
CP-376TA	Blister Card	45	TW	45	99
CP-376TN	Blister Card	45	TW	45	97
CP-376TR	Blister Card	45	TW	45	101
CP-376UR	Blister Card	40	TW	40	100
CP-376VR	Blister Card	40	TW	40	100
CP-380	Blister Card	40	TW	40	136
CP-382	Blister Card	45	TW	45	212
CP-384N	Blister Card	20	TW	20	110
CP-393	Blister Card	50	SH	50	103
CP-395	Blister Card	24	SH	24	212
CP-412G	Blister card	72	SH	72	134
CP-413G	Blister card	72	SH	72	134
CP-419	Blister Card	100	TW	100	134
CP-420	Blister card	60	SH	60	125
CP-460G	Blister Card	40	SH	40	108
CP-462G	Blister Card	40	SH	40	108
CP-463	Blister Card	60	TW	60	110
CP-463G	Blister card	40	SH	40	108
CP-505	Blister Card	60	TW	60	138
CP-508	Blister Card	60	TW	60	138
CP-511A	Blister Card	90	TW	90	135
CP-512	Blister Card	200	TW	200	138

Model No	Packing	QTY/CTN	C.O.O	M.O.Q.	Page
CP-5S1D	Blister Card	200	TW	200	106
CP-5S2D	Blister Card	200	TW	200	106
CP-751A	Blister Card	45	TW	45	108
CP-751B	Blister Card	45	TW	45	108
CP-751C	Blister Card	45	TW	45	108
CP-751E	Blister Card	45	TW	45	108
CP-751H	Blister Card	45	TW	45	108
CP-751N	Blister Card	45	TW	45	108
CP-751PA	Blister Card	45	TW	45	108
CP-FB01N	Color Box	100	SH	100	92
DK					
DK-2032	Shrink	12	TW	12	207
DK-2033N	Shrink	12	TW	12	207
DK-2034N	Shrink	6	TW	6	207
DK-2039	Blister Card	96	SH	96	203
DK-2040	Blister Card	96	SH	96	207
DK-2041	Blister Card	48	SH	48	207
DK-2042	Blister Card	36	SH	36	207
DK-2043	Blister Card	72	TW	72	92
DK-2047N	Blister Card	120	SH	120	202
DK-2060SET	Display Box	10	SH	10	207
DK-2112	Blister Card	48	SH	48	203
DP					
DP-033A	Poly Bag	300	SH	300	74
DP-033B	Poly Bag	300	SH	300	74
DP-033C	Poly Bag	300	SH	300	74
DP-033D	Poly Bag	300	SH	300	74
DP-033E	Poly Bag	300	SH	300	74
DP-3616	Blister Card	144	SH	144	77
DP-366A	Blister Card	100	SH	100	74
DP-366C	Blister Card	100	TW	100	73
DP-366D	Blister Card	60	SH	60	73
DP-366I	Blister Card	200	SH	200	73
DP-366J	Blister Card	100	SH	100	73
DP-366P	Blister Card	100	SH	100	74
FB					
FB-1601	Color Box	50	SH	50	91
FB-1602	Color Box	50	SH	50	91
FB-1618C	Color Box	20	SH	20	91
FB-1688C	Color Box	20	SH	20	91
FB-C008	Color Box	300	SH	25	93
FB-C009	Color Box	300	SH	25	93

Model No	Packing	QTY/CTN	C.O.O	M.O.Q.	Page
FB-C010	Blister Card	24	SH	24	93
FL					
FL-516	Blister card	144	SH	144	211
FL-528	Double Blister Card	100	SH	100	210
GK					
GK-360A	Double Blister Card	48	SH	48	71
GK-360F	Double Blister Card	48	SH	48	71
GK-361U	Double Blister Card	48	SH	48	72
GK-366U	Color Box	20	SH	20	72
GK-368	Blister Card	20	TW	20	72
GK-389B	Blister Card	20	SH	20	71
GK-390B	Blister Card	20	SH	20	71
GK-607160	Poly Bag	240	SH	240	72
GK-611160	Poly Bag	100	SH	100	72
GS					
GS-23K	Color Box	20	TW	20	67
HW					
HW-010	Blister Card	36	SH	36	166
HW-012	Blister Card	24	SH	24	166
HW-023	Blister Card	144	SH	144	161
HW-121L	Hanger Card	72	SH	72	163
HW-121M	Hanger Card	72	SH	72	163
HW-129	Blister Card	60	SH	60	162
HW-221M	Hanger Card	80	SH	80	163
HW-22401M	Color Sleeve Shrink	12	TW	12	169
HW-229B	Double Blister Card	24	SH	24	162
HW-229BL	Double Blister Card	24	SH	24	162
HW-230BL	Blister card	30	SH	30	161
HW-23801M	Color Sleeve Shrink	8	TW	8	170
HW-318	Blister Card	24	SH	24	165
HW-42401M	Color Sleeve Shrink	4	TW	4	170
HW-42601M	Color Sleeve Shrink	4	TW	4	169
HW-5907M	Plastic Box	20	SH	20	168
HW-609A	Hanger Card	100	SH	100	168
HW-609B	Hanger Card	100	SH	100	168
HW-612401M	Cardboard Box	1	TW	1	171
HW-6509B	Color Box	25	SH	25	167
HW-6514B	Color Box	12	SH	12	167
HW-7509B	Color Box	12	SH	12	167
HW-7513B	Color Box	6	SH	6	167
HW-T21-60340	Plastic Box + Shrink	12	TW	12	165
HW-T41-315	Plastic Box + Shrink	24	TW	24	165

Model No	Packing	QTY/CTN	C.O.O	M.O.Q.	Page
HW-V106B	B blister Card	144	SH	144	185
HW-V107B	B blister Card	144	SH	144	185
HW-V108B	B blister Card	144	SH	144	185
HW-V109B	B blister Card	144	SH	144	185
HW-V110B	B blister Card	144	SH	144	185
HW-V111B	B blister Card	144	SH	144	185
HW-V112B	B blister Card	132	SH	132	185
HW-V113B	B blister Card	132	SH	132	185
HW-V112B	B blister Card	132	SH	132	185
HW-V114B	B blister Card	132	SH	132	185
HW-V115B	B blister Card	132	SH	132	185
HW-V116B	B blister Card	48	SH	48	185
HW-V117B	B blister Card	48	SH	48	185
HW-V119B	B blister Card	48	SH	48	185
HW-V122B	B blister Card	42	SH	42	185
HW-V124B	B blister Card	36	SH	36	185
HW-V210B	B blister Card	24	SH	24	185
HW-V213B	B blister Card	24	SH	24	185
HW-V214B	B blister Card	12	SH	12	185
HW-V217B	B blister Card	12	SH	12	185
HW-V219B	B blister Card	12	SH	12	185
HW-V222B	B blister Card	12	SH	12	185
HW-V608	B blister Card	24	SH	24	184
HW-V610	B blister Card	18	SH	18	184
HW-V612	B blister Card	18	SH	18	184
HW-V710	B blister Card	12	SH	12	186
MA					
MA-014	B blister Card	120	SH	120	197
MA-016	B blister Card	48	SH	48	197
MA-019	B blister Card	80	SH	80	198
MA-020	B blister Card	120	SH	120	198
MA-021	B blister Card	120	SH	120	198
MA-022	B blister Card	480	SH	480	198
MA-023	B blister Card	144	SH	144	198
MA-025	Color Box	100	SH	100	197
MA-029	Color Box	120	SH	120	198
MA-1004A	Color Box	4	SH	4	197
MA-1004F	Color Box	4	SH	4	197
MA-1010U	Color Box	8	SH	8	196
MA-1013MA	Color Box	8	SH	8	197
MA-1013MF	Color Box	8	SH	8	197
MA-1209LA	Color Box	4	SH	4	196

Model No	Packing	QTY/CTN	C.O.O	M.O.Q.	Page
MA-1209LI	Color Box	4	SH	4	196
MA-1215CA	Color Box	6	SH	6	196
MA-1215CF	Color Box	6	SH	6	196
MA-1225CF	Color Box	4	SH	4	197
MS					
MS-004	Poly Bag	120	SH	120	213
MS-006	Poly Bag	96	SH	96	213
MS-008	Poly Bag	96	SH	96	213
MS-018	Poly Bag	120	SH	120	213
MS-035	Hanger Card	100	SH	100	213
MS-121	B blister Card	240	SH	240	208
MS-153A	B blister Card	120	SH	120	206
MS-153C	B blister Card	60	SH	60	206
MS-161	B blister Card	120	SH	120	213
MS-3176	B blister card	144	TW	144	158
MS-323	B blister Card	300	SH	300	208
MS-329	B blister Card	100	TW	100	211
MS-391	B blister Card	240	SH	240	209
MS-526	Double Blister Card	40	SH	40	210
MS-710	Color Box	180	SH	180	212
MS-9328	B blister Card	120	SH	120	211
MS-B126	B blister card	100	SH	100	208
MS-C001	B blister Card	100	TW	100	206
MS-C002	Color Box	60	TW	60	206
MS-C005I	Color Box	8	SH	8	206
MS-V001	B blister Card	72	SH	72	182
MS-V308	Hanger Card	200	TW	200	211
MT					
MT-1210	B blister Card	60	SH	60	37
MT-1217	Color Box	30	SH	30	35
MT-1220	Color Box	40	SH	40	36
MT-1225	Color Box	40	SH	40	36
MT-1226	Color Box	40	SH	40	37
MT-1232	Color Box	40	SH	40	36
MT-1233C	Double Blister Card	60	SH	60	37
MT-1233D	Double Blister Card	60	SH	60	37
MT-1236	Color Box	40	SH	40	36
MT-1270	Color Box	30	SH	30	35
MT-1280	Color Box	30	SH	30	35
MT-1280D	Color Box	30	SH	30	34
MT-1506	Color Box	64	SH	64	40
MT-1508	B blister Card	60	SH	60	40

Model No	Packing	QTY/CTN	C.O.O	M.O.Q.	Page
MT-1509	B blister Card	60	SH	0	40
MT-1510	Color Box	40	SH	40	38
MT-1630	B blister Card	60	SH	60	40
MT-1707	Color Box	30	SH	30	35
MT-1708	Color Box	30	SH	30	34
MT-1710N	Color Box	30	SH	30	33
MT-1820N	Color Box	30	SH	0	33
MT-2017N	Color Box	32	SH	32	41
MT-2019	Color Box	32	SH	32	41
MT-2207	Color Box	30	SH	30	42
MT-2208	Color Box	30	SH	30	42
MT-3102	Double Blister Card	20	SH	20	44
MT-3109	Double Blister Card	20	SH	20	44
MT-3110	Color Box	30	SH	30	43
MT-3202	Color Box	20	SH	20	43
MT-3209	Color Box	20	SH	20	43
MT-3266	Double Blister Card	20	SH	20	44
MT-4606	Color Box	40	SH	40	48
MT-4612	Double Blister Card	20	SH	20	48
MT-4615	Color Box	40	SH	40	49
MT-4616	Color Box	30	SH	30	49
MT-4617LED	Color Box	40	SH	40	49
MT-4618	Color Box	30	SH	30	49
MT-5110	Color Box	30	SH	30	39
MT-5211	Color Box	30	SH	30	39
MT-7028	Color Box	20	SH	20	29
MT-7029N	Color Box	20	SH	20	29
MT-7031	Color Box	96	SH	96	31
MT-7051N	B blister Card	48	SH	48	32
MT-7057N	Color Box	50	SH	50	32
MT-7058	Color Box	54	SH	54	31
MT-7059	Color Box	20	SH	20	30
MT-7063	Color box	54	SH	54	31
MT-7064	Color box	54	SH	54	31
MT-7071K	Color Box	16	SH	0	28
MT-7071N	Color Box	16	SH	16	28
MT-7076	Color Box	20	SH	40	27
MT-7501	Color Box	50	SH	50	90
MT-7501E	Color Box	100	SH	100	90
MT-7510	Color Box	50	SH	50	90
MT-7520E	Color Box	100	SH	100	90
MT-7530	Color Box	50	SH	50	90

SOCKET
WRENCHES

POWER TOOLS

ESD STATIC
PROTECTION

WIRE TOOLS

PRECISION
TWEEZERS

MAGNETIC
& LAMP

KNIVES
& SCISSORS

MISCELLANEOUS

INSTRUMENT
CASES

TOOL CASES

INDEX

Model No	Packing	QTY/CTN	C.O.O	M.O.Q.	Page
MT-7530E	Color Box	100	SH	100	90
MT-7601	Color Box	30	SH	30	89
MT-7602	Color Box	50	SH	50	87
MT-7603	Color Box	32	SH	32	89
MT-7610A	Color Box	6	SH	6	86
MT-7610F	Color Box	6	SH	6	86
MT-7612A	Inner Box	12	SH	12	86
MT-7612F	Inner Box	12	SH	12	86
MT-7615	Color Box	96	SH	96	88
MT-7616	Color Box	96	SH	96	88
MT-7617	Cardboard Box	96	SH	96	88
MT-7618	Cardboard Box	96	SH	96	88
MT-7620	Cardboard Box	30	SH	30	85
MT-7625	Color Box	20	SH	20	87
MT-7650	Cardboard Box	20	SH	2	85
MT-7801	Color Box	30	SH	30	89
MT-7802	Color Box	30	SH	30	89
MT-7901	Inner Box	1	SH	1	88
MT-8004	Color Box	54	SH	54	32
MT-9905	Blister Card	120	SH	120	42
MT-9906	Blister Card	120	SH	120	42
MT-9907	Blister Card	120	SH	120	42
NT					
NT-1933	Blister Card	200	TW	200	45
NT-1934	Blister Card	200	TW	200	45
NT-305N	Blister Card	120	SH	120	45
NT-306	Blister Card	100	SH	100	45
NT-309	Blister Card	60	SH	60	45
NT-310	Color Box	100	SH	100	45
NT-311	Blister Card	50	SH	50	48
NT-312	Blister Card	50	SH	50	48
NT-320	Blister Card	80	SH	80	45
NT-6350	Color Box	0	SH	0	46
NT-6370	Color Box	0	SH	0	46
OP					
OP-E351	Blister Card	50	TW	50	209
PA					
PA-101	Blister Card	144	SH	144	116
PA-103	Blister Card	144	SH	144	123
PD					
PD-151	Color Sleeve Shrink	50	SH	50	207
PD-161-C	Color Box	50	SH	50	207

Model No	Packing	QTY/CTN	C.O.O	M.O.Q.	Page
PD-2606	Blister Card	24	SH	24	214
PD-2607	Bulk	24	SH	24	214
PD-2609	Hanger Card	36	SH	36	214
PD-2612	Hanger Card	36	SH	36	214
PD-2616	Hanger Card	36	SH	36	214
PD-372	Blister Card	60	TW	60	213
PD-374	Blister Card	36	SH	36	213
PD-376	Inner Box + Color Label	8	SH	8	213
PD-394A	Blister Card	300	SH	300	204
PD-395A	Double Blister Card	10	SH	10	204
PD-398	Color Box	80	SH	80	204
PD-510	Blister Card	144	SH	144	204
PD-513	Blister card	288	SH	288	204
PD-515	Blister card	288	SH	288	203
PD-610	Blister Card	180	SH	180	208
PD-992	Blister Card	72	TW	12	203
PD-998	Blister card	144	SH	144	203
PD-V003A	Blister Card	72	SH	120	184
PD-V003B	Blister Card	72	SH	120	184
PD-V003D	Blister Card	72	SH	120	184
PD-V004A	Blister Card	72	SH	120	184
PK					
PK-1305NA	Inner Box + Color Label	2	SH	2	18
PK-1305NB	Inner Box + Color Label	2	SH	2	18
PK-15307BM	Inner Box + Color Label	2	SH	2	19
PK-15307EI	Inner Box + Color Label	2	SH	2	19
PK-15308BM	Color Box	2	SH	2	13
PK-15308EM	Color Box	2	SH	2	13
PK-1700NA	Inner Box + Color Label	2	SH	2	17
PK-1700NB	Inner Box + Color Label	2	SH	2	17
PK-1900NA	Inner Box + Color Label	2	SH	2	16
PK-1900NB	Inner Box + Color Label	2	SH	2	16
PK-1938M	Inner Box + Color Label	2	SH	2	7
PK-1938M1	Inner Box + Color Label	2	SH	2	7
PK-1938M2	Inner Box + Color Label	2	SH	2	7
PK-1938M3	Inner Box + Color Label	2	SH	2	7
PK-1938M4	Inner Box + Color Label	2	SH	2	7
PK-1938M5	Inner Box + Color Label	2	SH	2	7
PK-1990A	Inner Box + Color Label	2	SH	2	15
PK-1990B	Inner Box + Color Label	2	SH	2	15
PK-2002A	Color Sleeve Shrink	5	SH	5	20
PK-2002B	Color Sleeve Shrink	5	SH	5	20

Model No	Packing	QTY/CTN	C.O.O	M.O.Q.	Page
PK-2009A	Color Box	2	SH	2	12
PK-2009B	Color Box	2	SH	2	12
PK-2051T	Color Sleeve Shrink	6	SH	6	25
PK-2052TA	Color Sleeve Shrink	4	SH	4	25
PK-2052TB	Color Sleeve Shrink	4	SH	4	25
PK-2061	Color Label Shrink	8	TW	8	24
PK-2079	Inner Box + Color Label	8	TW	8	23
PK-2086A	Color Label Shrink	8	SH	8	23
PK-2086B	Color Label Shrink	8	SH	8	23
PK-2088A	Color Label Shrink	8	SH	8	22
PK-2088B	Color Label Shrink	8	SH	8	22
PK-2088BA	Color Label Shrink	8	SH	8	22
PK-2629	Color Label Shrink	6	SH	6	9
PK-2633	Color Sleeve Shrink	12	SH	12	10
PK-2635	Color Sleeve Shrink	10	SH	10	10
PK-2636	Color Sleeve Shrink	10	SH	10	11
PK-2637	Color Sleeve Shrink	10	SH	10	11
PK-2801	Inner Box + Color Label	12	SH	12	187
PK-2802	Inner Box + Color Label	6	SH	6	188
PK-2809M	Color Sleeve Shrink	4	SH	4	188
PK-2810A	Color Sleeve Shrink	5	SH	5	187
PK-2810B	Color Sleeve Shrink	5	SH	5	187
PK-2811M	Color Sleeve Shrink	4	SH	4	185
PK-2813M	Color Sleeve Shrink	4	SH	4	188
PK-2836M	Inner Box + Color Label	1	SH	1	189
PK-301	Color Box	24	SH	24	24
PK-324	Color Box	24	SH	24	24
PK-4013	Color Sleeve Shrink	8	SH	8	9
PK-4046BM	Inner Box + Color Label	2	SH	2	14
PK-4046BM2	Inner Box + Color Label	2	SH	2	14
PK-4302AI	Color Box	2	SH	2	8
PK-4302BM	Color Box	2	SH	2	8
PK-603	Color Sleeve Shrink	72	TW	72	123
PK-605	Color Sleeve Shrink	34	SH	34	123
PK-612NA	Color Sleeve Shrink	8	SH	8	22
PK-612NB	Color Sleeve Shrink	8	SH	8	22
PK-616A	Color Sleeve Shrink	5	SH	5	21
PK-616B	Color Sleeve Shrink	5	SH	5	21
PK-618A	Color Sleeve Shrink	8	SH	8	25
PK-618B	Color Sleeve Shrink	8	SH	8	25
PK-710KA	Color Box	6	SH	6	20
PK-710KB	Color Box	6	SH	6	20

Model No	Packing	QTY/CTN	C.O.O	M.O.Q.	Page
PK-810A	Color Sleeve Shrink	10	SH	10	23
PK-810B	Color Sleeve Shrink	10	SH	10	23
PK-813A	Color Sleeve Shrink	8	SH	8	21
PK-813B	Color Sleeve Shrink	8	SH	8	21
PK-9110	Blister Card	100	TW	100	158
PK-918F	Cardboard Box	60	SH	60	61
PK-9456	Color Box	6	SH	6	95
PK-9458	Inner Box + Color Label	2	SH	2	95
PK-9461	Color Label Shrink	8	SH	8	94
PK-9472A	Color Box	2	SH	2	94
PK-9472B	Color Box	2	SH	2	94
PM					
PM-101D	Blister Card	144	TW	144	113
PM-107	Blister Card	144	TW	144	116
PM-107C	Blister Card	144	TW	144	116
PM-200	Blister Card	144	TW	144	123
PM-202	Blister Card	144	TW	144	123
PM-203	Blister Card	144	TW	144	123
PM-251	Blister Card	144	TW	144	117
PM-30D	Blister Card	144	TW	144	113
PM-386	Blister Card	72	TW	72	212
PM-396F	Blister Card	144	TW	144	115
PM-396G	Blister Card	144	TW	144	115
PM-396H	Blister Card	144	TW	144	115
PM-396I	Blister Card	144	TW	144	115
PM-5101-C	Blister Card	144	TW	144	113
PM-708Y	Blister Card	120	TW	120	126
PM-711	Blister Card	120	TW	120	120
PM-712	Blister Card	120	TW	120	120
PM-731	Blister Card	96	SH	96	118
PM-736	Blister Card	96	SH	96	118
PM-737	Blister Card	96	SH	96	118
PM-746	Blister Card	96	SH	96	118
PM-754	Blister Card	96	SH	96	118
PM-755	Blister Card	96	SH	96	118
PM-804	Blister Card	36	SH	36	110
PM-805E	Blister Card	100	SH	100	122
PM-805F	Blister Card	100	TW	100	122
PM-806A	Blister Card	120	TW	120	122
PM-806B	Blister Card	120	TW	120	122
PM-806E	Blister Card	100	SH	100	122
PM-806F	Blister Card	120	TW	120	122

Model No	Packing	QTY/CTN	C.O.O	M.O.Q.	Page
PM-806FG	Blister Card	60	SH	60	93
PM-807E	Blister Card	60	SH	60	122
PM-901	Blister Card	60	TW	60	127
PM-903	Blister Card	60	TW	60	127
PM-905F	Blister Card	200	TW	200	119
PM-905FHC	Blister Card	100	TW	100	119
PM-908	Blister Card	120	TW	120	127
PM-909	Blister Card	120	TW	120	127
PM-910	Blister Card	72	SH	72	181
PM-911	Blister Card	24	SH	24	181
PM-912	Blister Card	72	SH	72	181
PM-916	Blister Card	72	SH	72	181
PM-917	Blister Card	72	SH	72	181
PM-918	Blister Card	24	SH	24	181
PM-919	Blister Card	72	SH	72	181
PM-925	Blister Card	120	TW	120	121
PM-955	Blister Card	120	TW	120	121
PM-956	Blister Card	120	TW	120	121
PN					
PN-086N	Blister Card	72	SH	72	128
PN-378D	Blister Card	36	TW	36	128
PN-378E	Blister Card	36	TW	36	128
PN-P010N	Blister Card	36	SH	36	128
PT					
PT-1206A	Color Sleeve Shrink	6	SH	6	173
PT-1206F	Color Sleeve Shrink	6	SH	6	173
PT-1362U	Color Box	10	SH	10	174
PT-1366U	Color Sleeve Shrink	20	SH	20	174
PT-1801A	Color Sleeve Shrink	5	SH	5	173
PT-1801F	Color Sleeve Shrink	5	SH	5	173
PT-32030D	Color Box	20	SH	20	174
PT-5100	Shrink	40	SH	40	176
PT-5201A	Blister Card	24	SH	24	176
PT-5201B	Blister Card	24	SH	24	176
PT-5202F	Color Box	20	SH	20	176
PT-5205U	Plastic Box	40	SH	40	175
PT-5206U	Color Box	10	SH	10	175
PT-5208U	Color Box	10	SH	10	175
PT-5501I	Color Sleeve Shrink	10	SH	10	176
SB					
SB-1007K	Poly Bag	80	TW	80	219
SB-1418	Color Sleeve Shrink	12	SH	12	217

Model No	Packing	QTY/CTN	C.O.O	M.O.Q.	Page
SB-1592	Color Label Shrink	72	SH	72	219
SB-1718	Color Label Shrink	9	SH	9	217
SB-1918	Color Label Shrink	6	SH	6	217
SB-2419	Color Label Shrink	60	SH	60	219
SB-2918	Color Label Shrink	24	SH	24	218
SB-3218	Color Label Shrink	20	SH	20	218
SB-3428SB	Color Label Shrink	20	SH	20	218
SB-510	Color Label Shrink	4	SH	4	217
SD					
SD-081A	Color Box	72	TW	72	154
SD-081F	Blister Card	100	TW	100	153
SD-081G	Blister Card	100	TW	100	153
SD-081H	Color Box	72	TW	72	154
SD-081-P1	Blister Card	300	TW	300	153
SD-081-P2	Blister Card	300	TW	300	153
SD-081-P3	Blister Card	300	TW	300	153
SD-081-P4	Blister Card	300	TW	300	153
SD-081-P5	Blister Card	300	TW	300	153
SD-081-P6	Blister Card	300	TW	300	153
SD-081-P7	Blister Card	300	TW	300	153
SD-081-S1	Blister Card	300	TW	300	153
SD-081-S2	Blister Card	300	TW	300	153
SD-081-S3	Blister Card	300	TW	300	153
SD-081-S4	Blister Card	300	TW	300	153
SD-081-S5	Blister Card	300	TW	300	153
SD-081-S6	Blister Card	300	TW	300	153
SD-081-S7	Blister Card	300	TW	300	153
SD-081-S8	Blister Card	300	TW	300	153
SD-081-TA20	Blister Card	300	TW	300	153
SD-081-TA23	Blister Card	300	TW	300	153
SD-081-TA27	Blister Card	300	TW	300	153
SD-081-TRI0	Blister Card	300	TW	300	153
SD-081-TRI00	Blister Card	300	TW	300	153
SD-081-TRI000	Blister Card	300	TW	300	153
SD-081-TRI1	Blister Card	300	TW	300	153
SD-081-TRIY06	Blister Card	300	TW	300	153
SD-0839	Pouch	60	TW	60	152
SD-083-P2	Blister Card	300	TW	300	152
SD-083-P3	Blister Card	300	TW	300	152
SD-083-P4	Blister Card	300	TW	300	152
SD-083-S3	Blister Card	300	TW	300	152
SD-083-S4	Blister Card	300	TW	300	152

SOCKET
WRENCHES

POWER TOOLS

ESD STATIC
PROTECTION

WIRE TOOLS

PRECISION
TWEEZERS

MAGNETIC
& LAMP

KNIVES
& SCISSORS

MISCELLANEOUS

INSTRUMENT
CASES

TOOL CASES

INDEX

Model No	Packing	QTY/CTN	C.O.O	M.O.Q.	Page
SD-083-S5	Blister Card	300	TW	300	152
SD-083-T4	Blister Card	300	TW	300	152
SD-083-T5H	Blister Card	300	TW	300	152
SD-083-T6H	Blister Card	300	TW	300	152
SD-205	Plastic Box + Shrink	12	TW	12	151
SD-2301	Color Box	32	SH	32	144
SD-2302	Color Box	32	SH	32	144
SD-2309	Color Label Shrink	12	TW	12	151
SD-2310	Color Label Shrink	24	TW	24	151
SD-2320M	Blister Card	36	SH	36	150
SD-2400-S10	Blister Card	200	TW	200	153
SD-2400-S4	Blister Card	200	TW	200	153
SD-2400-S6	Blister Card	200	TW	200	153
SD-2400-S8	Blister Card	200	TW	200	153
SD-2404	Blister Card	100	TW	100	153
SD-2800-M10	Double Blister Card	96	TW	96	148
SD-2800-M13	Double Blister Card	96	TW	96	148
SD-2800-M5	Double Blister Card	96	TW	96	148
SD-2800-M5.5	Double Blister Card	96	TW	96	148
SD-2800-M7	Double Blister Card	96	TW	96	148
SD-2800-M8	Double Blister Card	96	TW	96	148
SD-3502	Color Box	96	TW	96	157
SD-5101A	Inner Box	360	SH	360	147
SD-5101B	Inner Box	360	SH	360	147
SD-5102A	Inner Box	360	SH	360	147
SD-5102B	Inner Box	360	SH	360	147
SD-5105A	Inner Box	360	SH	360	147
SD-5105B	Inner Box	360	SH	360	147
SD-5106A	Inner Box	240	SH	240	147
SD-5106B	Inner Box	240	SH	240	147
SD-5107A	Inner Box	240	SH	240	147
SD-5107B	Inner Box	240	SH	240	147
SD-5107D	Blister Card	120	SH	120	150
SD-5110A	Inner Box	240	SH	240	147
SD-5110B	Inner Box	240	SH	240	147
SD-5113A	Inner Box	240	SH	240	147
SD-5113B	Inner Box	240	SH	240	147
SD-5114B	Inner Box	180	SH	180	147
SD-5116A	Inner Box	240	SH	240	147
SD-5116B	Inner Box	240	SH	240	147
SD-5120B	Inner Box	360	SH	360	147
SD-8012	Shrink	7	SH	7	183

Model No	Packing	QTY/CTN	C.O.O	M.O.Q.	Page
SD-803	Color Box	10	TW	10	157
SD-810-P0	Double Blister Card	144	SH	144	183
SD-810-P1	Double Blister Card	96	SH	96	183
SD-810-P2	Double Blister Card	96	SH	96	183
SD-810-S2.5	Double Blister Card	144	SH	144	183
SD-810-S3.0	Double Blister Card	144	SH	144	183
SD-810-S4.0	Double Blister Card	144	SH	144	183
SD-810-S5.5	Double Blister Card	96	SH	96	183
SD-810-S6.5	Double Blister Card	108	SH	108	183
SD-9314	Color Sleeve Shrink	72	TW	72	158
SD-9322M	Color Label Shrink	48	SH	48	158
SD-9326M	Color Sleeve Shrink	16	TW	16	159
SD-9608	Color Box	80	SH	80	156
SD-9701M	Double Blister Card	24	SH	24	150
SD-9802	Double Blister Card	36	SH	36	155
SD-9803	Plastic Box + Color Lable	72	TW	72	154
SD-9804	Double Blister Card	24	SH	24	156
SD-9814	Blister Card	144	SH	144	156
SD-9816	Blister Card	36	TW	36	149
SD-9820	Blister card	48	SH	48	149
SD-9821	Blister card	36	SH	36	148
SD-9824	Color Sleeve Shrink	48	TW	48	154
SD-9826	Color Box	36	SH	36	155
SD-9827M	Color Box	24	SH	24	155
SD-9828	Color Sleeve Shrink	40	TW	40	159
SD-9857M	Double Blister Card	24	SH	24	149
SD-T635-0112	Plastic Box + Shrink	24	TW	24	166
SD-T635-16	Plastic Box + Shrink	24	TW	24	166
SD-T635-510	Plastic Box + Shrink	24	TW	24	166
SD-V861	Blister Card	12	SH	12	187
SH					
SH-1025	Blister Card	80	SH	80	76
SI					
SI-124B-100	Blister Card	50	TW	50	64
SI-124B-40	Blister Card	50	TW	50	64
SI-124B-60	Blister Card	50	TW	50	64
SI-125A-20	Blister Card	80	TW	80	62
SI-126B-100	Blister Card	48	SH	48	64
SI-126B-80	Blister Card	48	SH	48	64
SI-129B-40	Blister Card	40	SH	40	63
SI-129B-60	Blister Card	40	SH	40	63
SI-130A-20	Blister Card	80	SH	80	62

Model No	Packing	QTY/CTN	C.O.O	M.O.Q.	Page
SI-130B-20	Blister Card	40	SH	40	62
SI-130B-25	Blister Card	40	SH	40	62
SI-131B	Blister Card	40	SH	40	61
SI-132A	Color Sleeve Shrink	20	SH	20	66
SI-132B	Color Sleeve Shrink	20	SH	20	66
SI-138A	Color Sleeve Shrink	20	SH	20	66
SI-138B	Color Sleeve Shrink	20	SH	20	66
SI-139A	Blister Card	40	SH	40	62
SI-139B	Blister Card	40	SH	40	62
SI-168U	Plastic Box	50	SH	50	66
SI-169U	Plastic Box	50	SH	50	66
SI-186A	Blister Card	40	SH	40	61
SI-186F	Blister Card	40	SH	40	61
SI-B161	Blister Card	80	TW	80	65
SI-B162	Blister Card	100	SH	100	65
SI-B165	Color Box	50	SH	50	65
SI-B166	Blister Card	20	SH	20	65
SI-B20L	Color Box	50	SH	50	66
SI-S120T-4B	Poly Bag w/ Hanger Card	100	SH	100	79
SI-S120T-4BC	Poly Bag w/ Hanger Card	100	SH	100	79
SI-S120T-4C	Poly Bag w/ Hanger Card	100	SH	100	79
SI-S120T-4SB	Poly Bag w/ Hanger Card	200	SH	200	79
SI-S120T-5B	Poly Bag w/ Hanger Card	100	SH	100	79
SI-S120T-6B	Poly Bag w/ Hanger Card	100	SH	100	79
SI-S120T-6BC	Poly Bag w/ Hanger Card	100	SH	100	79
SI-S120T-6C	Poly Bag w/ Hanger Card	100	SH	100	79
SI-S120T-6SB	Poly Bag w/ Hanger Card	200	SH	200	79
SK					
SK-V410B	Blister Card	72	SH	72	186
SK-V411B	Blister Card	72	SH	72	186
SK-V412B	Blister Card	72	SH	72	186
SK-V413B	Blister Card	72	SH	72	186
SK-V414B	Blister Card	72	SH	72	186
SK-V416B	Blister Card	72	SH	72	186
SK-V417B	Blister Card	72	SH	72	186
SK-V418B	Blister Card	72	SH	72	186
SK-V419B	Blister Card	72	SH	72	186
SK-V422B	Blister Card	72	SH	72	186
SK-V424B	Blister Card	72	SH	72	186
SK-V752	Blister Card	32	SH	32	186
SK-V851	Blister Card	60	SH	60	186
SK-V852	Blister Card	30	SH	30	186

Model No	Packing	QTY/CTN	C.O.O	M.O.Q.	Page
SN					
SN-002	Blister Card	40	SH	40	77
SN-390	Color Box	20	SH	20	75
SN-392	Color Box	24	SH	24	76
SN-394	Blister Card	48	TW	48	76
SN-396N	Color Box	10	SH	10	75
SR					
SR-015	Blister Card	80	TW	80	128
SR-2046	Blister Card	48	TW	48	92
SR-330	Blister Card	100	SH	100	202
SR-332	Blister Card	100	SH	100	202
SR-333	Blister Card	200	TW	200	202
SR-336	Blister Card	72	TW	72	200
SR-338	Blister Card	72	TW	72	201
SR-339	Blister Card	48	TW	48	201
SR-363A	Blister Card	60	TW	60	129
SR-363B	Blister Card	60	TW	60	129
SR-366	Blister Card	48	TW	48	202
SR-538	Blister card	10	TW	10	130
SR-V206	Blister Card	36	SH	36	182
SR-V210	Blister Card	32	SH	32	182
SR-V336	Blister Card	48	SH	96	182
SR-V537	Blister Card	24	SH	24	182
SS					
SS-202A	Color Box	20	SH	20	60
SS-202F	Color Box	20	SH	20	60
SS-206B	Color Box	8	SH	8	59
SS-206E	Color Box	8	SH	8	59
SS-207B	Color Box	8	SH	8	59
SS-207E	Color Box	8	SH	8	59
SS-208B	Color Box	8	SH	8	58
SS-256B	Color Box	4	SH	4	57
SS-257B	Color Box	4	SH	4	57
SS-259B	Color Box	4	SH	4	57
SS-306B	Cardboard Box	8	SH	8	58
SS-331B	Color Box	2	SH	2	56
SS-331E	Color Box	2	SH	2	56
SS-532B	Color Box	20	SH	20	68
SS-551B	Color Box	20	SH	20	68
SS-552B	Color Box	20	SH	20	68
SS-553B	Color Box	16	SH	16	68
SS-554B	Color Box	16	SH	16	68
SS-562BN	Color Box	6	SH	6	68

Model No	Packing	QTY/CTN	C.O.O	M.O.Q.	Page
SS-571B	Color Box	6	SH	6	68
SS-593B	Color Box	4	SH	4	60
SS-596A	Color Box	4	SH	4	60
SS-596F	Color Box	4	SH	4	60
SS-602B	Color Box	20	SH	20	70
SS-602E	Color Box	20	SH	20	70
SS-611A	Color Sleeve Shrink	5	SH	5	70
SS-611B	Color Sleeve Shrink	5	SH	5	70
SS-615B	Color Box	10	SH	10	69
SS-626B	Color Box	10	SH	10	69
SS-628A	Color Box	20	SH	20	70
SS-628F	Color Box	20	SH	20	70
SS-955B	Cardboard Box	4	SH	4	56
SS-956B	Color Box	4	SH	4	53
SS-968B	Color Box	4	SH	4	55
SS-969B	Color Box	6	SH	6	55
SS-969E	Color Box	6	SH	6	55
SS-979B	Color Box	6	SH	6	54
SS-979E	Color Box	6	SH	6	54
SS-988B	Cardboard Box	1	SH	1	51
SS-988E	Cardboard Box	1	SH	1	51
SS-989B	Color Box	4	SH	4	52
SS-989E	Color Box	4	SH	4	52
ST					
ST-12B	Poly Bag	5	SH	5	225
ST-13S	Hanger Card	20	SH	20	225
ST-2012H	Hanger Card	30	SH	30	225
ST-308	Poly Bag	10	SH	10	227
ST-4029	Hanger Card	10	TW	10	225
ST-5102	Hanger Card	6	SH	6	228
ST-5105	Hanger Card	8	SH	8	228
ST-5204	Hanger Card	45	SH	45	228
ST-5208	Hanger Card	40	SH	40	228
ST-5301	Color Label	4	SH	4	226
ST-5302	Color Label	8	SH	8	227
ST-5309	Color Label	10	SH	10	226
ST-5310	Color Label	10	SH	10	227
ST-5502	Hanger Card	40	SH	40	228
ST-5503	Hanger Card	100	SH	100	228
ST-5504	Hanger Card	60	SH	60	228
SW					
SW-201	Inner Box	48	TW	48	203
SW-2125H	Blister Card	80	TW	80	146

Model No	Packing	QTY/CTN	C.O.O	M.O.Q.	Page
SW-9106	Blister card	40	TW	40	147
SW-9107D	Blister Card	100	TW	100	150
SW-9109D	Blister Card	50	TW	50	150
TC					
TC-2009	Color Box	4	SH	4	224
TC-285	Color Label Shrink	4	SH	4	216
TC-286	Color Label Shrink	6	SH	6	216
TC-287	Color Label Shrink	8	SH	8	216
TC-311	Color Box	2	SH	2	223
TC-736	Color Box	2	SH	2	223
TC-755	Color Box	2	SH	2	224
TC-756	Color Box	4	SH	4	222
TC-850	Color Box	4	SH	4	223
TE					
TE-5305B	Color Box	2	SH	2	47
TE-6201F-W	Inner Box	1	SH	1	84
TE-6305A	Cardboard Box	8	SH	8	47
TE-6305F	Cardboard Box	8	SH	8	47
TE-6801F-W	Inner Box	1	SH	1	82
TE-8202A	Inner Box	1	SH	1	83
TE-8202A-W	Inner Box	1	SH	1	83
TE-8202F	Inner Box	1	SH	1	83
TE-8202F-W	Inner Box	1	SH	1	83
TZ					
TZ-100A	Blister Card	300	SH	300	194
TZ-100B	Blister Card	300	SH	300	194
TZ-100C	Blister Card	300	SH	300	194
TZ-100D	Blister Card	300	SH	300	194
TZ-101D	Blister Card	300	SH	300	194
TZ-101E	Blister Card	300	SH	300	194
TZ-116	Blister Card	300	TW	300	192
TZ-121	Blister Card	72	SH	72	194
TZ-202N	Blister Card	300	TW	300	191
TZ-204N	Blister Card	300	TW	300	191
TZ-205N	Blister Card	300	TW	300	191
TZ-212N	Blister Card	300	TW	300	191
TZ-300A	Blister Card	300	SH	300	194
TZ-300B	Blister Card	300	SH	300	194
TZ-V302A	Blister Card	72	SH	72	184
TZ-V302B	Blister Card	72	SH	72	184
TZ-V302C	Blister Card	72	SH	72	184
TZ-V302D	Blister Card	72	SH	72	184

SOCKET
WRENCHES

POWER TOOLS

ESD STATIC
PROTECTIONVACUUM
TOOLSPRECISION
TWEEZERSMAGNETIC
& LAMPKNIVES
& SCISSORS

MISCELLANEOUS

INSTRUMENT
CASES

TOOL CASES

INDEX

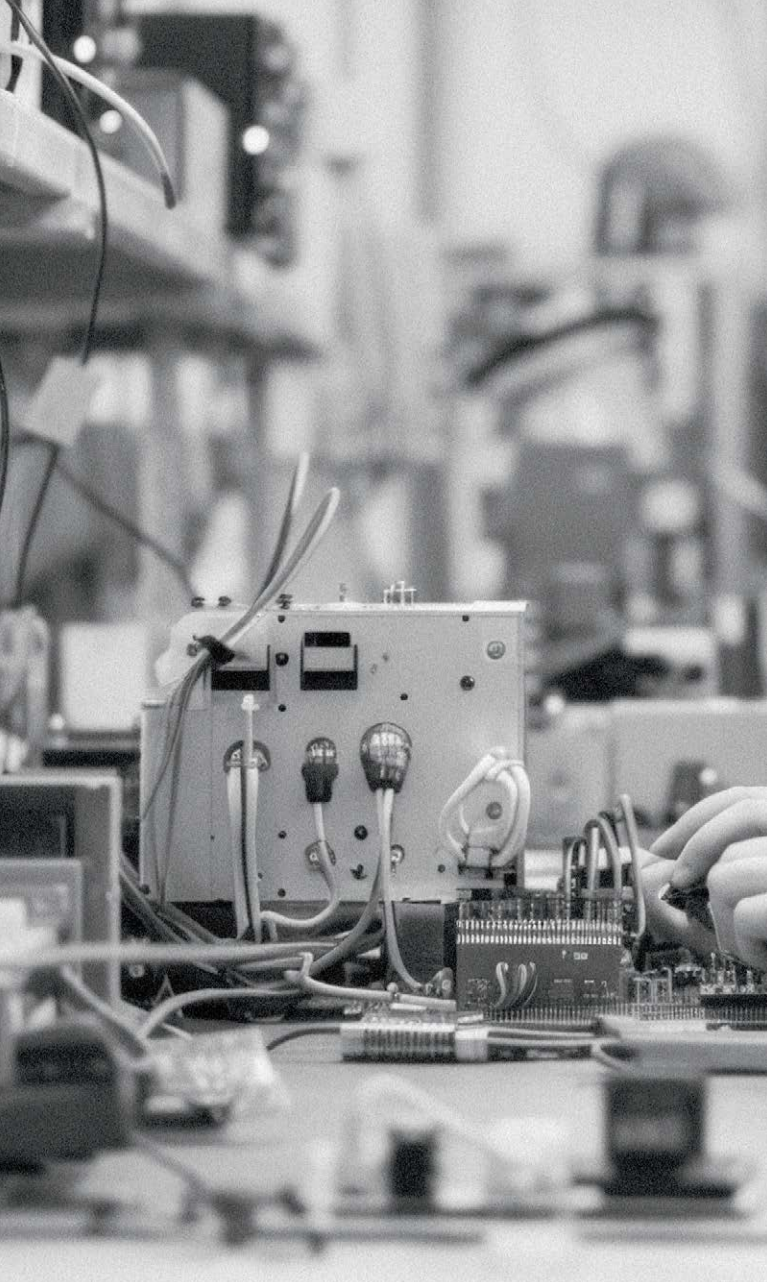

EDUCATION

In Taiwan, Pro'sKit's connection to the education market runs deep. For almost three decades, we have been the supplier for technical schools with more than 90% market share, providing students with specialized tool kits that prepares them for the professional world, in disciplines such as electrical, electronics, computer, networking, refrigeration and auto field.



MAKER

In addition to our tool brand, our sub-brand and STEM certified Pro'sKit Science Kit allowed us to deepen our roots into a wider audience in education. Since 2017, we have held numerous workshops, developed textbooks, collaborated with schools to help students enter the maker field.

SERVICE

Our amazing support team will ensure you have the best aftercare service. Contact directly with your sales representative, or leave a message at our official website.



DISTRIBUTOR SECTION



Order Management



Variation Notice



Stop Offer Notice

MARKETING SUPPORT



Video



Feature Page



Shop Display



STAY CONNECTED





A friend that you can trust



Professional Tool Solutions Since 1991



Certificate Number: TW9812323.01

TAIPEI HEADQUARTER

5F., No. 7, Ln. 130, Minquan Rd., Xindian Dist., New Taipei City, Taiwan, 231023

Tel. | +886 2 2218 3233
Mail | pk@mail.prokits.com.tw

SHANGHAI BRANCH

No. 25, Ln. 1365, Kangqiao E Rd., Kangqiao Industrial Zone, Shanghai, China

Tel. | +86 21 6818 3050
Mail | sha@mail.prokits.com.tw