

DC UPS FN SNMP

12V/20A SNMP

24V/10A SNMP

24V/15A SNMP

-48V/5A SNMP

-48V/10A SNMP



DC UPS FN

- Compact and easy to install
- 3-Stage Battery Charger
- Continuous power
- Fixing in rails of 19"

1U

APPLICATION

The ALGcom DC UPS line is designed to protect your equipment against surges and faults, ensuring excellent performance and preventing your equipment from potential problems in the field.

COMPACT AND EASY TO INSTALL

The ALGcom DC UPS Line was thought to meet 1U Design standards. Taking up little space, with possibility of installation in vertical and horizontal, the ALGcom DC UPS is performance and efficiency guarantee in telecom.

BATTERIES CHARGER

Designed to work with lead acid batteries, the ALGcom Nobreak DC UPS feature a 3-stage charger, described below. An intelligent algorithm that runs on the microcontroller controls the charger.

Stage 01- Bulk: Operates with constant current that can be programmed, depending on the model, in 1A, 3A, 5A or 10A, allowing gradual and controlled charging of the batteries. When they reach full charge, the charger goes to the next stage.

Stage 02-Absortion: At this stage, the charger applies a constant voltage in order to equalize the voltage of each cell of the battery. In this way, the effect of premature sulfating of the plates is reduced, promoting an increase in the battery charge capacity and, consequently, its lifespan. Once equalization occurs, the charger switches to the next stage.

Stage 03-Float: This is the final stage of the battery charging process, where a constant fluctuating voltage is applied in order to cancel out the self-discharge effect, allowing the battery to remain in its best state of charge for a long period.

Nobreak Mode: Responsible for powering the devices in the event of a grid fail.

CHARGER CONFIGURATION				
MODEL	1A	3A	5A	10A
12V / 20A	x	x	x	x
24V / 10A	x	x	x	
24V / 15A	x	x	x	x
-48V / 5A	x	x	x	
-48V / 10A	x	x	x	

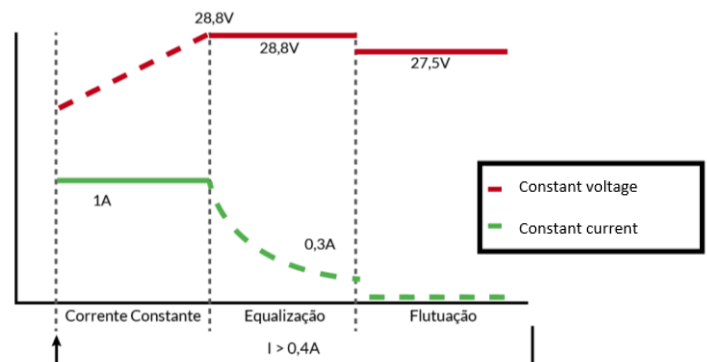

The graph above shows the charging stages of the battery charger, illustrating the behavior of the voltage and current of the batteries as well as the migration point from one stage to the next. Current values might vary depending on the source model

Note: Graph for a charger configured for a load current 1A.

FUNCTIONAL DIAGRAM

FUNCTIONAL DIAGRAM FOR MODELS 12V/20A, 24V/10A, 24V/15A:

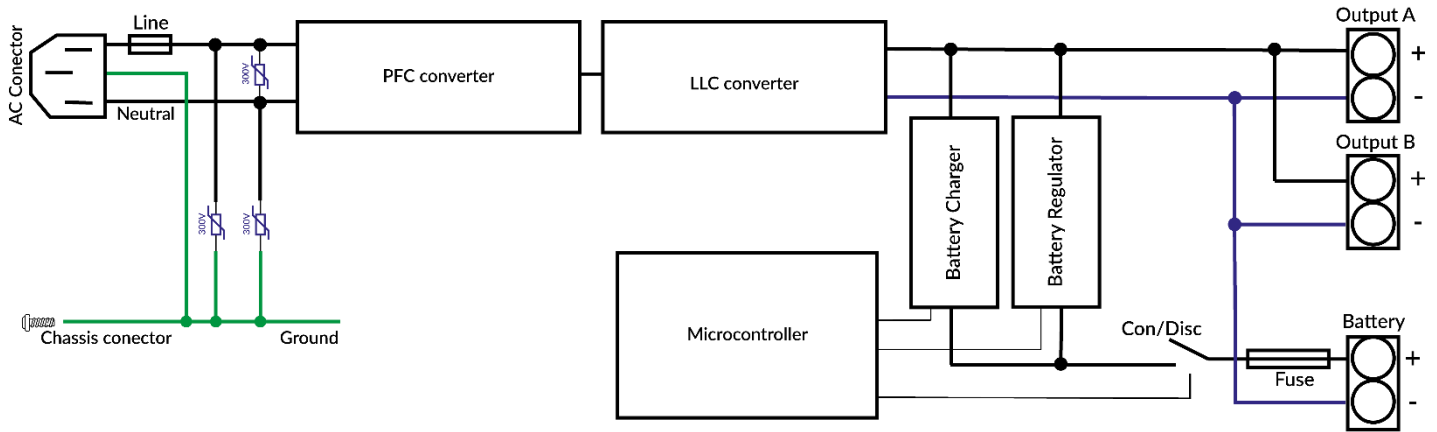

FUNCTIONAL DIAGRAM FOR MODELS -48V/5A AND -48V/10A:

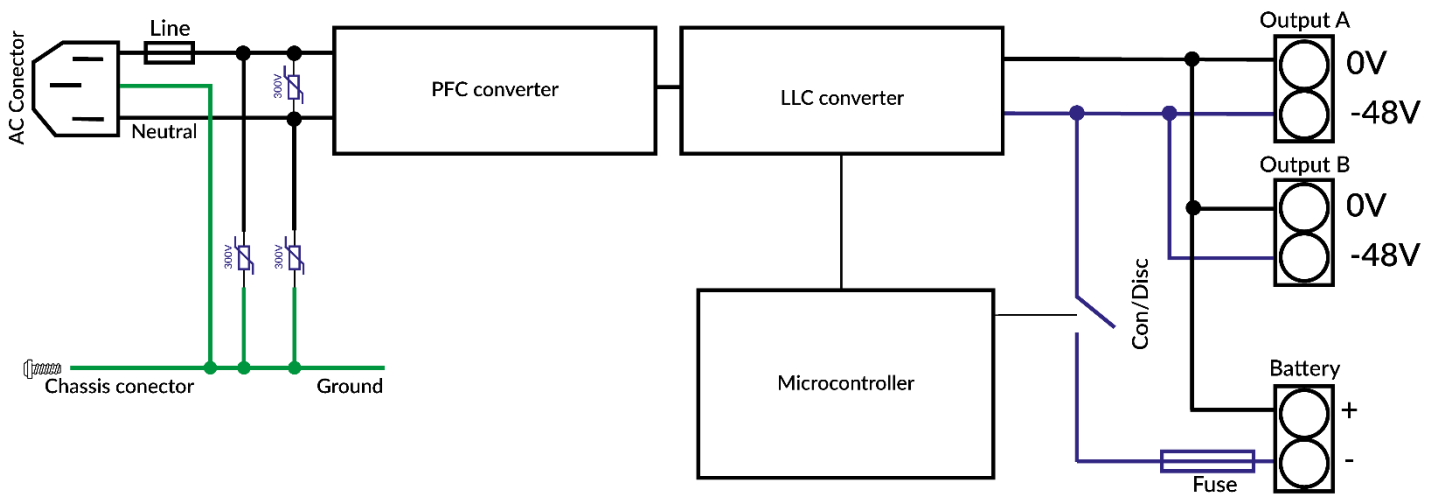

MICROCONTROLLED SMART DC UPS

The DC UPS features a microprocessor that runs the battery-charging algorithm, battery under voltage protection, Nobreak operation mode, time control for AC power return. All these functions are done with the mathematical protections such as short circuit, input power loss, transient AC to battery, short circuit with battery connected, over temperature, are performed by fast analog circuits designed to protect the DC UPS, the user and the load connected to it. We put together the best of digital with the best of analog.

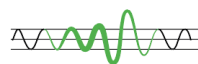

Outbreaks: protects the DC UPS against lightning or various atmospheric discharge.

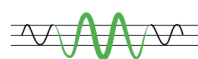

Over voltages: protects against the effects of electrical distribution network maneuver.

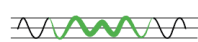

Falls: protects against the effect that happens in installations when the distribution grid receives high load.



Under voltages: prevents a drop in the level of the electrical signal, a problem usually caused by the imbalance in the distribution of electric power.



Noise: prevents that the interference in the electrical network caused by electromagnetic emission or by radio frequency transmissions interferes with the DC UPS output.



Electrical faults: caused by faults in the power supply

The output voltage varies depending on the model of the source and the mode of operation. Please see chart below.

Model	Nobreak Mode Output Voltage		Output voltage AC mode
12V 20A	$V_{BAT} > 12V = 12V$	$V_{BAT} < 12V = V_{BAT}$	12V
24V 15A 24V 10A	$V_{BAT} > 24V = 24V$	$V_{BAT} < 24V = V_{BAT}$	24V
-48V 10A -48V 5A	42V to 58V according to the state of the battery bank		

The chart below shows the power for equipment according to the charger configuration.

Model	Total output power	Maximum Charger			Minimum Charger		
		Equipment power	Equipment output current	Charger current	Equipment power	Equipment output current	Charger current
12V 20A	240W	120W	10A	10A	228W	19A	1A
24V 10A	240W	120W	5A	5A	216W	9A	1A
24V 15A	360W	120W	5A	10A	336W	14A	1A
-48V 5A	270W	108W	2A	3A	216W	4A	1A
-48V 10A	540W	270W	5A	5A	486W	9A	1A

REGULATORY COMPLIANCE

ELECTROMAGNETIC IMMUNITY

Electrostatic discharge (ESD)	IEC 61000-4-2	Contact discharge	8kV	Criterion C*
		Discharge through the air	15kV	
Fast transients (Burst)	IEC 61000-4-4	Power input	4kV	Criterion A*
		Source output	1kV	
Outlet voltage surge (Surge)	IEC 61000-4-5	Phase -> Neutral	4kV	Criterion A*
		Line -> Ground; Neutral -> Ground	4kV	
Output voltage surge (Surge)	IEC 61000-4-5	+ -> -	1kV	Criterion A*
		+ -> Ground; - -> Ground	1kV	
Voltage dip (Dips)	IEC 61000-4-11	0% - 100Vac	0Vac,20ms	Criterion A*
		40% - 100Vac	40Vac,200ms	
		70% - 100Vac	70Vac,500ms 0Vac,20ms	
		0% - 220Vac	88Vac,200ms	
		40% - 220Vac	154Vac,500ms	
		70% - 220Vac		
Voltage interruption	IEC 6100-4-11	0% - 220Vac	5000ms	Criterion C*

* **Criterion A:** Power supply has normal behavior with the output at its set value.

* **Criterion C:** Temporary loss of function is possible. The power supply may shut down and return to normal operation.

ELECTRICAL SAFETY

IN/OUTPUT	SELV	IEC 60950-1 Double isolation or reinforced isolation
Protection class	I	Needs ground connection
Leakage current	Typical<0,1mA/0,2mA Typical<0,4mA/1,0mA	100Vac,60hz 264Vac,60hz

DIELECTRIC STRENGTH

Line + Neutral for output	3000 Vac	During 60s
Line + Neutral for ground	2500 Vac	
Output to ground	1000 Vac	

ISOLATION

Phase + Neutral for output	>5 Mohm	500 vcc test
Phase + Neutral for ground		
Output to ground		

REMOTE MANAGEMENT

ALGcom Manageable DC UPS allow access to information through the Ethernet interface of the device. Two ways to access are available: WEB interface via internet browser and interface via SNMP protocol using network management tools.

- ARM M4 120Mhz processor;
- 10/100 Ethernet network port;

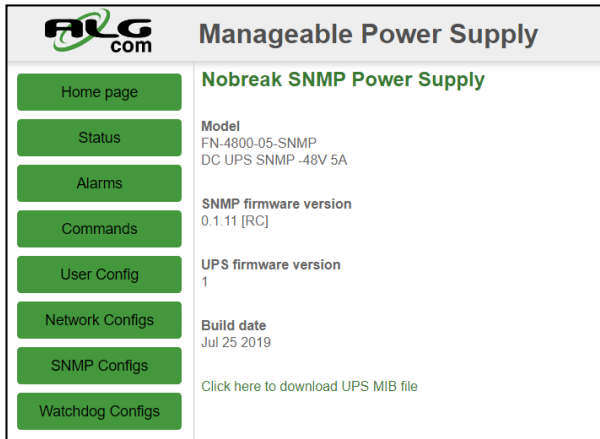

Download the MIB file from the HomePage tab.

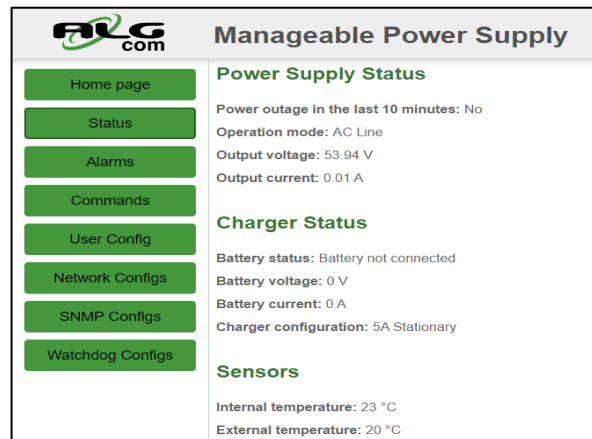

Monitor operating parameters Status tab, such as output voltage and current and battery bank.

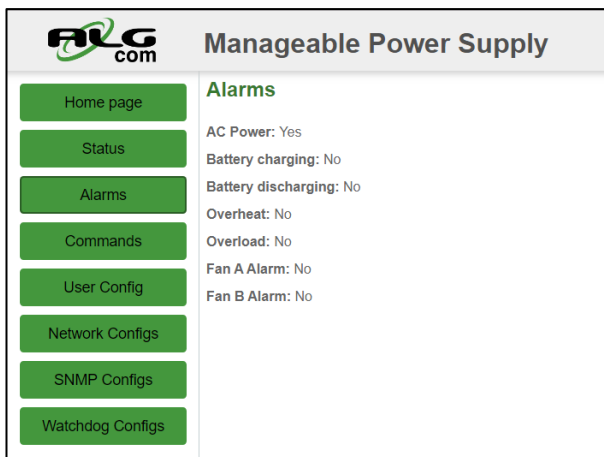

Possibility to monitor over temperature, overcharge, battery charging or discharging alerts and the operation of the coolers.

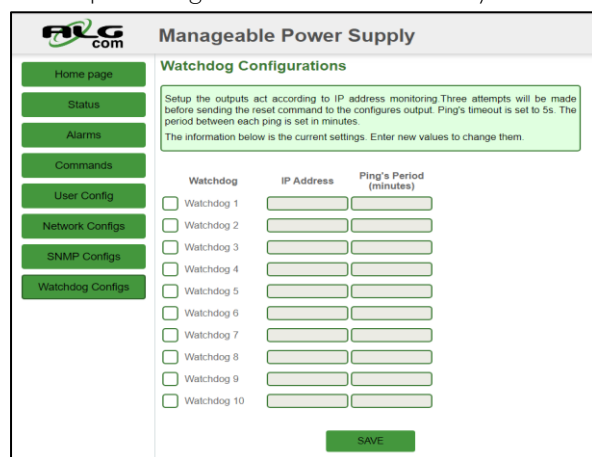

Possibility to program up to 10 Watchdogs that reset the DC UPS output, that means, turns off temporarily the source output.

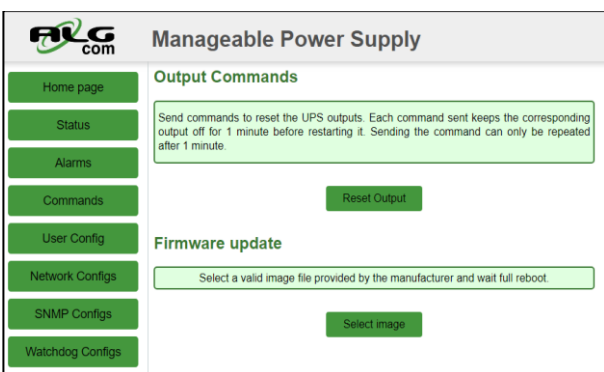

Possibility to turn off the source output for approximately 10 seconds and update the firmware remotely from the SNMP card.

PROTOCOL SNMP INTERFACE

SNMP is a standard protocol for monitoring and managing networks. SNMP stands for Simple Network Management Protocol. SNMP is designed to monitor and manage networks through management tools that allows working with products and services from a variety of vendors. We provide template for Zabbix. The image below is an example of how SNMP works on Zabbix. We provide also instructions for The Dude.

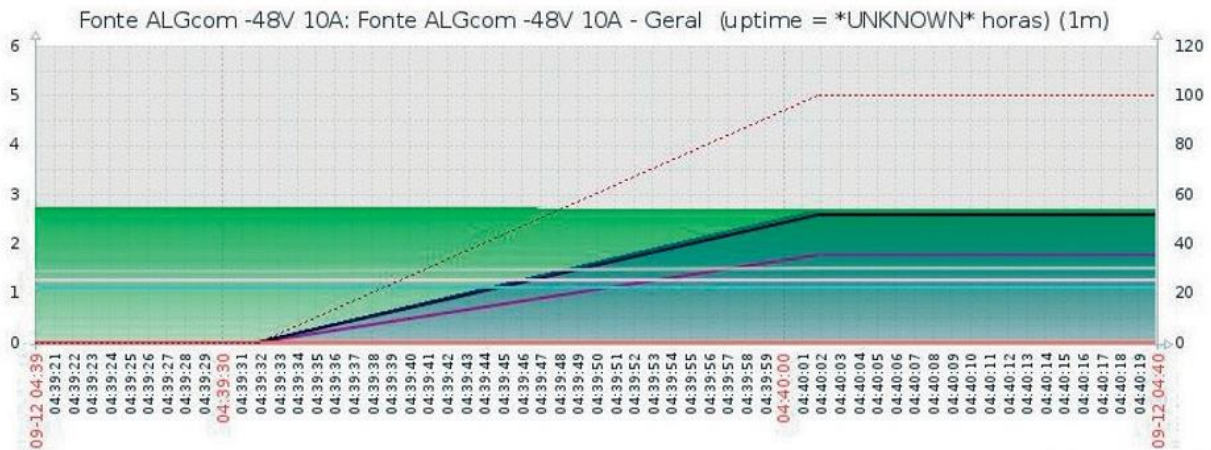

- Battery Bank Voltage
- Source Output Voltage
- AC/DC Power Source Output Current
- Battery Bank Current
- Alarm falls AC (> 0 fault in last 10 min)
- External temperature (cable)
- Internal temperature DC UPS
- Heatsink internal temperature
- Battery Status

	last	min	avg	max
[avg]	53	0	26.5	53
[avg]	53	53	53.5	54
[avg]	1.78	0	0.8915	1.78
[avg]	2.57	0	1.29	2.57
[avg]	0	0	0	0
[avg]	22	22	22	22
[avg]	30	29	29.5	30
[avg]	25	25	25	25
[avg]	5	0	2.5	5

EXTERNAL TEMPERATURE SENSOR

The external temperature sensor provides an additional tool for the customer and can be used to monitor the temperature of the rack, battery compartment, and more. Its temperature can be read both by the Web interface and by the SNMP protocol, having a dedicated OID to the sensor.

DIMENSIONS AND WEIGHT

Height (a)	45 mm
Width (b)	225 mm
Depth (c)	240 mm
Weight	2,35 kg



FREE DISTANCE FOR VENTILATION

a	30 mm
b	30 mm

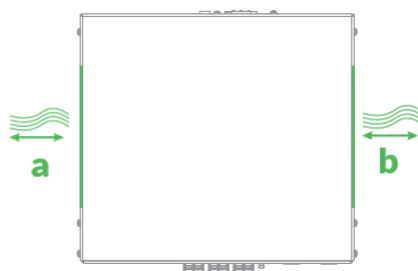

PACKING

Material	Cardboard
Height (A)	71 mm
Width (L)	286 mm
Depth (P)	334 mm
Weight	3,1kg

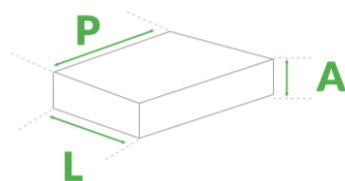

ATTENTION TO GUARANTEE!



Installation and maintenance should be performed by trained and authorized personnel to minimize hazards to oneself and others.



It is installer's responsibility to **comply with regulations** applied to the installation, as well as follow the instructions of this guide.



Use **only components and fixing elements** provided by ALGcom.



Perform at least one **annual installation inspection** to verify the equipment conditions.



DO YOU USE BATTERY BANK?

Use ALGcom Outdoor Enclosures with battery space.



+55 54 3201.1903 | sales@algcom.com.br
Caxias do Sul - RS | Brazil | www.algcom.com.br

